

Lighting management

Detection solutions



:hager



Manage the lighting in your buildings effectively

In France, the construction sector accounts for 20% of greenhouse gas emissions. Lighting represents over 10% of total annual electricity consumption.

The 2020 Environmental Regulation (RE2020), in force since 1 January 2022, prioritises energy efficiency and reducing the carbon intensity of energy.

In this environmental and regulatory context, constraints on lighting management are a particular priority for residential and commercial buildings alike. For example, it must be possible to turn off lights in the various common areas of unoccupied commercial premises.

Our range of detectors lets you choose the most effective way to manage lighting and meet these requirements.



**Detection
performance**



**Discreet
results**



**Easy
installation**

Overview of the ceiling range

19 different options for a clearer view in any situation

Our detectors allow you to manage and automate lighting in residential and commercial buildings easily and efficiently. You can choose from a complete range of high-performance presence and motion detectors.

Basic detectors 6 m zone



The entry-level solution

- Integrated motion and presence detection
- Detection perimeter: 6 m
- Flush mounted or surface mounted
- Available in ON/OFF version



Catalogue references
EE804A, EE805A

Mini detectors

10 m zone



The discreet solution

- Integrated motion and presence detection
- Detection perimeter: 10 m
- Flush mounted
- Available in ON/OFF or KNX versions



Catalogue references
EER501, TXD501

Large area detectors 20 m zone

The right solution for commercial buildings



- Integrated motion and presence detection
- Detection perimeter: 20 m
- Flush mounted or surface mounted
- Available in ON/OFF, KNX or DALI versions



Catalogue references
EER503, EER513, TXD503,
TXC513, EED503, EED513

Corridor detectors 30 x 5 m zone

The right solution for high traffic areas



- Motion detection
- Detection perimeter:
30 x 5 m, specially designed
for high traffic areas.
- Flush mounted or surface mounted
- Available in
ON/OFF, KNX or DALI versions



Catalogue references
EER505, EER515, TXD505,
TXC515, EED505, EED515

Hall detectors 22 x 12 m zone

The right solution for high ceilings



- Motion detection
- Detection perimeter:
22 x 12 m, specially
designed for warehouses
and high-ceilinged buildings
- Flush mounted
- Available in
ON/OFF, KNX or DALI versions



Catalogue references
EER518, TXC518, EED518

Use case

A range designed to suit all sites

Our detectors adapt to suit different environments, with options that include presence and/or motion sensors plus a choice of flush or surface-mounting. We also offer specific systems for buildings with highceilings and a very discreet mini version.



Private houses

- Entrance
- Hallway
- Basement and garage

Recommended range:
Basic and mini



Multi-occupancy dwellings

- Common areas:
entrance, hallway and staircase
- Garage blocks

Recommended range:
Basic, 20 m, corridor



Offices

- Office floors
- Meeting rooms
- Individual offices
- High traffic areas

Recommended ranges:

**Basic, mini,
large area, corridor**



Warehouses, supermarkets

- High traffic areas
- Stockrooms/storage areas

Recommended range:

Hall



KNX model

Our KNX range is ideal for total building management or even for more advanced lighting control: Variation, scenarios, etc.



DALI model

The DALI range is perfect for managing the finer details of lighting: Colorimetry, power, white temperature, etc.

Why choose our solution?

Choose a solution that's both simple and effective

01

Detection performance

The sharp perimeter and increased sensitivity ensure optimal detection.

The basic, mini and 20 m versions incorporate both presence and motion sensors for greater efficiency.

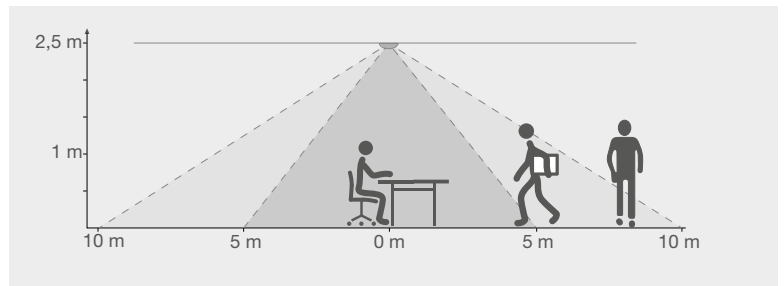

02

A perfect result

Discreet design with almost invisible mounts.

Our patented claws won't damage ceilings, and the zone blocking stickers to place on the lens will ensure a professional result.

The mini version is ideal for areas requiring discretion.

03

Ease of use

Easy to install

thanks to our patented claw fixings designed for easy assembly, disassembly and adjustment.

Easy cable connections

with horizontal or vertical infeeds.



For the 20 m options, corridor, flush mounted



Claw fittings

- Held outside of the ceiling for easy configuration
- Ceilings are not damaged, even if the device should come loose
- Comfortable grip, easy and safe to install

Protective bracket

- To secure access to terminal blocks.
- Compliant with NFC15-100.

Supplied with tightening clamp

- Ensures cable infeeds are held securely.

Quick connect terminals

- For tool-free cable fixing.

Loop through terminals

- So you can connect several lighting circuits.

For the 20 m options, corridor, hall, surface mounted



Connection base and sensing head can be separated

- Practical adjustment at floor level.
- Head and base clip together easily.
- Sensing head can be changed on its own.
- Base suitable for installation in standard surface mounting boxes (DCL boxes).

Mounting screws and "direction of installation" sticker supplied

- For practical and error-free installation, particularly for the corridor and hall options that are specific to motion detection.



Installation

Install with ease

Flush mounted

Hole diameter



Basic: 73 mm



Mini: 51/54 mm



20 m: 68 mm

The connection



Screwless terminal



With loop through function



Choice of master/slave/override function

Ceiling mounting



Mounting brackets
20 m and corridor



Basic and mini
mounting brackets



Settings accessible
from the side

Surface mounting

Fixing



Standard surface mounting box (DCL)

The connection



Screwless terminal



With loop through function



Choice of master/slave/override function

Ceiling mounting



Base and sensing head can be separated



Settings accessible from the side of the sensing head

Motion detection/ presence detection

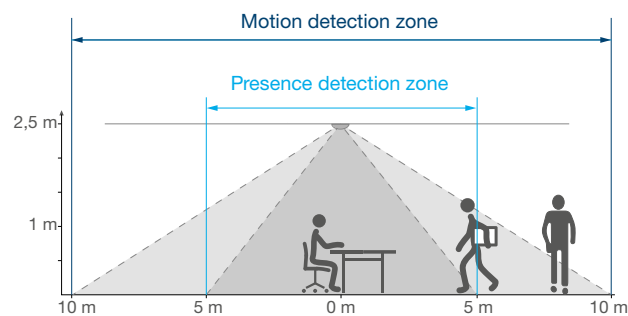

Pair the detector with a compatible ecosystem

To complete your set up, have a look at our other lighting management solutions.

Managing outside lighting



**LED floodlights
EE633/EE631**

For both presence detection and lighting, an all in one product.



**Sensor
EE8xx**

For presence detection and activation of outside lighting.

Management and control of interior lighting



**Automatic switch
WXF051**

For automated lighting at busy entrances and exits.



**Power switch
ESC125S**

To switch off large lighting circuits safely.



**Programme clock
EGN200**

For automated lighting in common and outside areas.

How to choose the right detector

Defining exactly what you need from your detector is essential in choosing the right model. Just ask yourself 5 quick questions.

01 How is the target area used?

The first thing to ask is where the detector is going to be used.

- Inside or outside?
- In a small space?
- Large office floor?
- Corridor?
- Spaces with high ceilings

This question will define the type of product and its detection zone, so you can choose the detector best suited to the area.

02 How will it be installed?

Will the detector be installed on the ceiling, on the wall or in wiring accessories?

Will it be surface mounted or flush mounted?

- Ceiling mounted/wall mounted/in wiring accessories?
- Surface mounted/flush mounted?

The type of fixings and cable infeeds will determine the specific assembly.

Note that the type of assembly may depend on the application.



03

What do you want the detector to do?

How will the installation be controlled?

Will the detector be the master or slave in the installation?

And will it have a pushbutton override?

- Master?
- Slave?
- With override?

Each detector comprises all or some of these functions.

So it's important to define exactly what you need so you can choose the right detector.

04

What type of technology should I go for?

There are 3 main control technologies used for detection in buildings.

- ON/OFF
- KNX
- DALI 2

The ON/OFF versions will generally be used in traditional installations while the KNX and DALI versions are more suitable for smart buildings.

05

How is the target area used?

Are there lots of comings and goings or are people generally sitting quietly, like in an office?





































- Motion?
- Motion and presence?

Depending on the answer, you can decide whether to opt for a motion-only detector, or a motion and presence system that also detects micro-movements.



Selection guide

Easily find the right [option](#) to suit your application

	ON / OFF										
	Installation										
	Ceiling, flush mounted				Ceiling, surface mounted				Wall	Wiring accessories	
Application	EE805A	EER501	EER503	EER505	EE804A	EER513	EER515	EER518	EE820/EE821 EE830/EE831 EE840/EE841 EE860/EE861 EE870/EE871 EE850	WE052(T) WE053(T) WE054(T)	WXF052 WXF051 WXF054
Entrances											
Small offices											
Sanitary facilities Changing rooms Machine rooms											
Large offices Meeting rooms											
Office floors Reception rooms											
Class rooms											
High traffic areas Corridors Stairwells											
Halls, Warehouses High-ceilinged buildings, Sports centres											
Covered parking areas											
Outside detection											



Installation

Installation

Ceiling, flush mounted



































Ceiling, surface mounted

Wall

Wiring

Ceiling, flush mounted

Ceiling, surface mounted

TXD501	TXD503	TXD505	TXC513	TXC515	TXC518	TRE700 TRE500	WXT501 WXT505	EED503	EED505	EED513	EED515	EED518
												
												
												
												
												
												
												
												
												
												

Overview of the range

Versions	Basic 6 m	Mini 10 m	Large area 20 m	Corridor	High ceilings
----------	-----------	-----------	-----------------	----------	---------------

Communication

ON/OFF 2 wires								
ON/OFF 3 wires	EE804A	EE805A	EER501	EER503	EER513	EER505	EER515	EER518
KNX			TXD501	TXD503	TXC513	TXD505	TXC515	TXC518
DALI				EED503	EED513	EED505	EED515	EED518

Mounting

Flush mounted	•		•	•		•		
Surface mounted		•			•		•	•
Wiring accessories (45x45)								
Wall mounted								

Application

Round area	•	•	•	•	•			
Specially for offices (square)			•	•	•			
Specially for corridors						•	•	
High ceilings								•
Discreet version			•					
Outside application								

Detection

Detection angle	360°	360°	360°	360°	360°	360°	360°	360°
Mounting height	2.5 – 3.5 m	2.5 – 3.5 m	2.5 – 3.5 m	2.5 – 3.5 m	2.5 – 3.5 m	2.5 – 3.5 m	2.5 – 3.5 m	6 – 9 m
Detection zone	Ø 6 m	Ø 6 m	Ø 10 m	Ø 20 m	Ø 20 m	30 x 5 m	30 x 5 m	22 x 12 m
Square office area			7 x 7 m	14 x 14 m	14 x 14 m			

Function

Motion	•	•	•	•	•	•	•	•
Presence	•	•	•	•	•			
Brightness	•	•	•	•	•	•	•	•

Use

Master function			•	•	•	•	•	•
Slave function	•	•	•	•	•	•		•

Connection

Quick-connect terminal/screw	Screw	Quick	Quick	Quick	Quick	Quick	Quick	Quick
Loop through terminal			•	•	•	•	•	•
input				•	•	•	•	•
Remote control adjustment			EE807 (inst.) EE808 (user)	EE807 (inst.) EE808 (user)		EE807 (installer) EE808 (user)		EE807 (inst.) EE808 (user)

Technical data

Ingress/Impact protection	IP21/IK04	IP21/IK04	IP41/IK04	IP41/IK04	IP41/IK04	IP41/IK04	IP41/IK04	IP41/IK04
Mounting hole diameter	Ø 73 mm		Ø 54 mm	Ø 68 mm		Ø 68 mm		
Time delay	5 sec – 30 min	5 sec – 30 min	5 sec – 60 min	5 sec – 60 min	5 sec – 60 min	5 sec – 60 min	5 sec – 60 min	5 sec – 60 min
Breaking capacity	10 A	10 A	10 A	10 A	10 A	10 A	10 A	10 A
Max LED Power	20x20 W	20x20 W	20x20 W	20x20 W	20x20 W	20x20 W	20x20 W	20x20 W

Basic version 6 meters



Motion and presence detector

- For spaces requiring modern, high-performance equipment
- Zero-crossing contact compatible with LED loads
- Removable sensing head on the surface mounted version for easier installation

Applications

- Residential applications
- High traffic areas
- Entrance
- Small offices
- Hotel rooms

Product features

	EE804A	EE805A
Motion function	•	•
Presence function	•	•
Brightness function	•	•
Master function		
Slave function		
Manual override via push button		

Options

Description	Mounting	Technology	Cat. ref.
Basic motion/presence detector 6 m ON/OFF flush mounted	Flush mounted	ON/OFF	EE805A
Basic motion/presence detector 6 m ON/OFF surface mounted	Surface mounted	ON/OFF	EE804A

Hole diameter

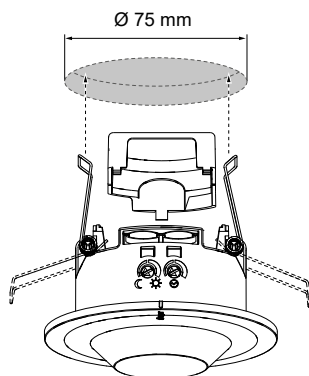

Detection zone

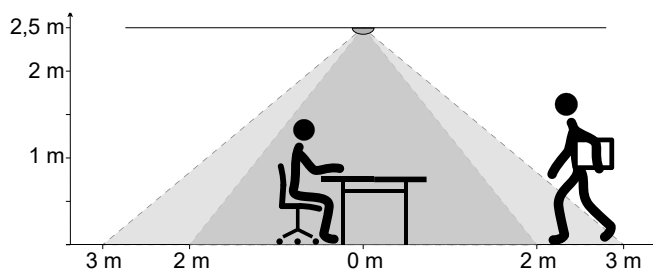

Technical specifications

	EE804A	EE805A
Supply voltage	230 V ~, +10%/-15% 240 V ~, +6/-6% 50/60 Hz	
Standby power consumption	< 0.3 W	
Switching time Operation Factory setting	Adjustable 5 sec – 30 min ~ 3 min	
Response brightness Factory setting	Adjustable 5 – 1000 Lux 200 Lux	
Recommended installation height	2.5 m – 3.5 m	
Maximum installation height	4 m	
Detection zone motion diameter (fitting height 2.5 m) across the detector Frontal movement towards the detector	6 m 4 m	
Detection zone presence diameter (Fitting height 2.5 m)	4 m	
Detection angle	~ 360°	
Contact power 230 V incandescent halogen lamp LED/compact fluorescent lamps Electrical transformer Electronic transformer Parallel compensated fluorescent tubes Fluorescent tubes with electronic ballast	10 A 2300 W 20 x 20 W (400 W) 1500 VA 1500 W 1000 W 1000 W	
Operating temperature	-5°C to +45°C	
Storage/transport temperature	-25°C to +70°C	
Ingress/Impact Protection and/ Protection Class	IP21/IK 04 II	
Dimensions Flush mounted version (Ø x H) Surface mounted version (Ø x H)	Ø 100 x 50 mm	Ø 90 x 61 mm
Terminal capacity Screwless terminals (loop through)	1 – 2.5 mm ²	

Connection

ON/OFF wiring

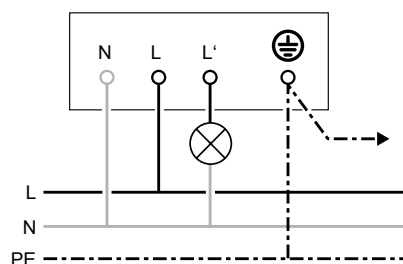

Mini version 10 meters



Mini motion and presence detector

- For spaces requiring discreet equipment.
- Can be adjusted with the EE807 remote control
- Controlled with the EE808 remote control
- Can function as both master and slave
- Zero-crossing contact compatible with LED loads
- LED status visible on the front of the product

Applications

- Residential applications
- High traffic areas
- Entrance
- Small offices
- Hotel rooms

Product features

	EER501	TXD501
Motion function	•	•
Presence function	•	•
Brightness function	•	•
Master function	•	•
Slave function	•	•
Manual override via push button	•	

Options

Description	Mounting	Technology	Cat. ref.
Mini motion/presence detector 10 m ON/OFF	Flush mounted	ON/OFF	EER501
Mini motion/presence detector 10 m KNX e / s	Flush mounted	KNX (e / s)	TXD501

Hole diameter

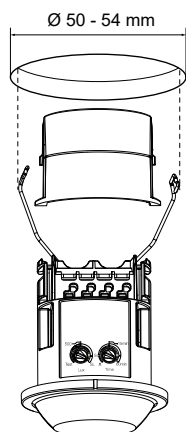

Detection zone

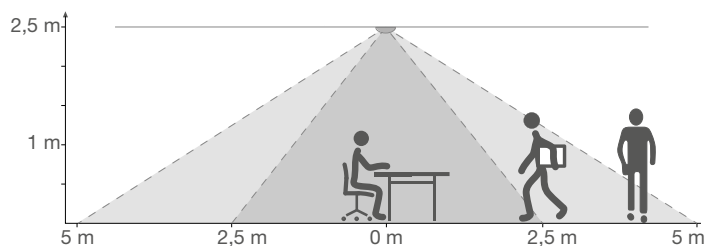

Technical specifications

	EER501	TXD501
Supply voltage	230 V ~, +10%/-15% 240 V ~, +6/-6% 50/60 Hz	
Standby power consumption	< 0.5 W	
Switching time Operation Factory setting	Adjustable 5 sec – 60 min - pulse (2s) ~ 15 min	
Response brightness Factory setting	Adjustable 5 – 2000 Lux 500 Lux	
Recommended installation height	2.5 m – 3.5 m	
Maximum installation height	4 m	
Detection zone motion diameter (fitting height 2.5 m) Across the detector Frontal movement towards the detector	10 m 5 m	
Detection zone presence diameter (Fitting height 2.5 m)	5 m	
Detection angle	~ 360°	
Cable length from the first to the last device	max. 50 m	-
Number of slave devices per master	max. 10	-
Contact power 230 V incandescent halogen lamp LED/compact fluorescent lamps Electrical transformer Electronic transformer Parallel compensated fluorescent tubes Fluorescent tubes with electronic ballast	10 A 2000 W 20 x 20 W (400 W) 1500 VA 1500 W 1000 W/130µF 1000 W	
Operating temperature	-5°C to +45°C	
KNX information Configuration mode Power supply KNX rated voltage Current consumption	- - - -	e / s Via bus 30 V DC Max. 10 mA
Storage/transport temperature	-20°C to +70°C	
Ingress/Impact Protection and Protection Class	IP41/IK 04 II	
Dimensions Flush mounted version (Ø x H)	Ø 62 x 86.2 mm	
Terminal capacity Screwless terminals (loop through)	0.5 – 2.5 mm ²	

Connection

ON/OFF wiring + Push button

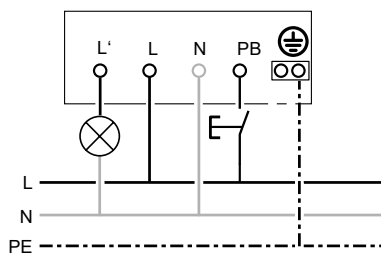

Master/slave wiring (max. slave ≤ 10)

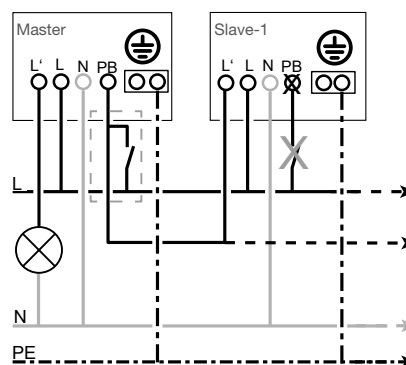

5 meters presence detector



Motion and presence detector

- High precision detection.
- Can be adjusted with the EE807 remote control
- Controlled with the EE808 remote control
- Surface mounting boxes white EEK005, black EEK005B
- Protection basket EEK006

Applications

- Commercial applications
- Office floors
- Reception areas

Product features

	EE815	EE816
Motion function	•	•
Presence function	•	•
Brightness function	•	•
Push button override	•	•
Automatic/Semi-automatic mode	•	•

Options

Description	Mounting	Technology	Cat. ref.
Motion/Presence detector 8 m ON/OFF flush mounted	Flush mounted	ON/OFF	EE815
Motion/Presence detector 8 m ON/OFF surface mounted	Surface mounted	ON/OFF	EE815 + EK005/B
Motion/Presence detector 8 m DALI flush mounted	Flush mounted	DALI	EE816
Motion/Presence detector 8 m DALI surface mounted	Surface mounted	DALI	EE816 + EK005/B

Hole diameter

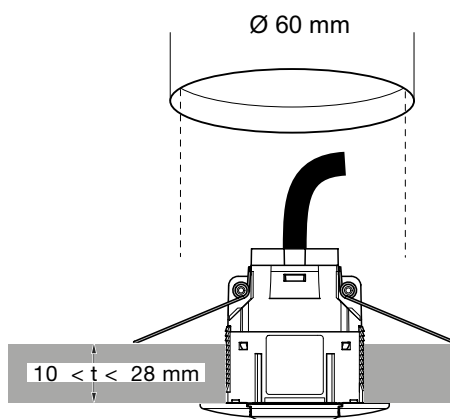

Detection zone

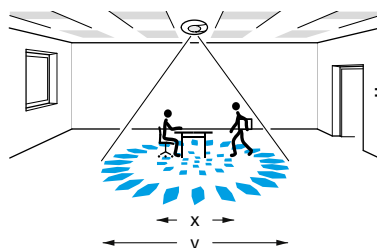

h	2,5 mm	3 m	3,5 m
x	5 m	5 m	5 m
y	7 m	8 m	9 m

Technical specifications

	EE815	EE816
Supply voltage	230 V ~, +10%/-15% 240 V ~, +6/-6% 50/60 Hz	230 V ~, +10%/-15% 240 V ~, +6/-6% 50/60 Hz
Standby power consumption	< 0.5 W	< 0.06 W
Switching time Operation Factory setting	Adjustable 60 sec – 60 min ~ 20 min	
Response brightness Factory setting	Adjustable 5 – 1000 Lux 400 Lux	
Recommended installation height	2.5 m – 3.5 m	
Maximum installation height	3.5 m	
Detection zone motion diameter (fitting height 2.5 m) Across the detector Frontal movement towards the detector	9 m 7 m	
Detection zone presence diameter (Fitting height 2.5 m)	5 m	
Detection angle	~ 360°	
Contact power 230 V incandescent halogen lamp LED/compact fluorescent lamps Electrical transformer Electronic transformer Parallel compensated fluorescent tubes Fluorescent tubes with electronic ballast	16 A AC1 2300 W 23 x 23 W 1500 VA 1500 W 1000 W/130µF 1000 W	- - - - - - -
DALI information Rated DALI voltage Guaranteed current	- -	16 V 48 mA
Operating temperature	-10°C to +45°C	
Storage/transport temperature	-20°C to +60°C	
Ingress/Impact Protection and Protection Class	IP41/IK 03 II	
Terminal capacity Screwless terminals (loop through)	0.5 – 1.5 mm ²	0.5 – 1.5 mm ²

Connection

ON/OFF wiring + Push button
EE815

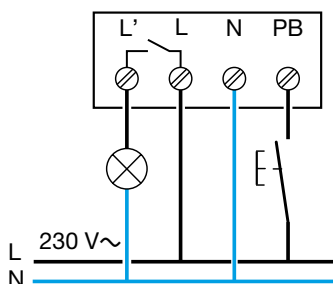

DALI cabling system
EE816

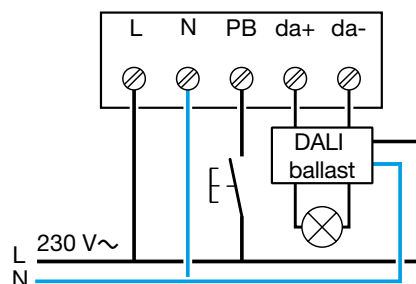

20 meters version



Large area motion and presence detector

- For spaces requiring modern, high-performance equipment
- Can be adjusted with the EE807 remote control
- Controlled with the EE808 remote control
- Can function as both master and slave
- Zero-crossing contact compatible with LED loads
- LED status visible on the front of the product

Applications

- Commercial applications
- Office floors
- Reception areas
- High traffic areas

Product features

	EER503/EER513	TXD503/TXC513	EED503/EED513
Motion function	•	•	•
Presence function	•	•	•
Brightness function	•	•	•
Master function	•	•	•
Slave function	•	•	
Forcing via wired button	•		•

Options

Description	Mounting	Technology	Cat. ref.
Large area motion/presence detector 20 m, ON/OFF flush mounted	Flush mounted	ON/OFF	EER503
Large area motion/presence detector 20 m, ON/OFF surface mounted	Surface mounted	ON/OFF	EER513
Large area motion/presence detector 20 m, KNX e / S flush mounted	Flush mounted	KNX e / S	TXD503
Large area motion/presence detector 20 m, KNX e / S surface mounted	Surface mounted	KNX e / S	TXC513
Large area motion/presence detector 20 m, DALI 2 flush mounted	Flush mounted	DALI 2	EED503
Large area motion/presence detector 20 m, DALI 2 surface mounted	Surface mounted	DALI 2	EED513

Hole diameter

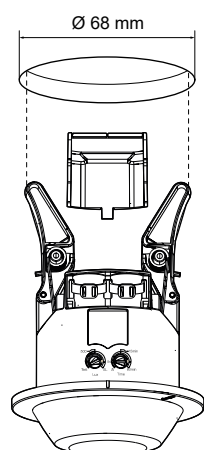

Detection zone

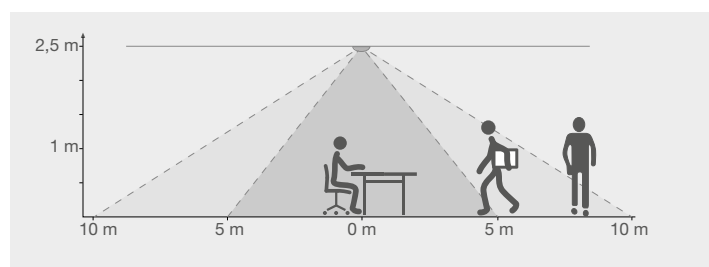

Technical specifications

	EER503/EER513	TXD503/TXC513	EED503/EED513
Supply voltage	230 V ~, +10%/-15% 240 V ~, +6/-6% 50/60 Hz	-	230 V ~, +10%/-15% 240 V ~, +6/-6% 50/60 Hz
Standby power consumption	< 0.5 W	-	< 0.5 W
Switching time Operation Factory setting	Adjustable 5 sec – 60 min - pulse (2s) ~ 15 min	-	-
Response brightness Factory setting	Adjustable 5 – 2000 Lux 500 Lux	-	-
Recommended installation height	2.5 m – 3.5 m	-	-
Maximum installation height	4 m	-	-
Detection zone motion diameter (fitting height 2.5 m) Across the detector Frontal movement towards the detector	20 m 10 m	-	-
Detection zone presence diameter (Fitting height 2.5 m)	10 m	-	-
Detection angle	~ 360°	-	-
Cable length from the first to the last device	max. 50 m	-	-
Number of slave devices per master	max. 10	-	-
Contact power 230 V incandescent halogen lamp LED/compact fluorescent lamps Electrical transformer Electronic transformer Parallel compensated fluorescent tubes Fluorescent tubes with electronic ballast	10 A 2000 W 20 x 20 W (400 W) 1500 VA 1500 W 1000 W/130µF 1000 W	- - - - - - -	- - - - - - -
Number of DALI devices	-	-	max. 24
DALI information Rated DALI voltage Guaranteed current Maximum current	- - -	- - -	16 V 48 mA 250 mA
KNX information Configuration mode Power supply KNX rated voltage Current consumption	- - - -	e/s Via bus 30 V DC Max. 10 mA	- - - -
Operating temperature	-5°C to +45°C	-	-
Storage/transport temperature	-20°C to +70°C	-	-
Ingress/Impact Protection and Protection Class	IP41/IK 04 II	-	-
Dimensions Flush mounted version (Ø x H) Surface mounted version (Ø x H)	Ø 85 x 75.9 mm Ø 105 x 59.7 mm	-	-
Terminal capacity Screwless terminals (loop through)	0.5 – 2.5 mm ²	-	0.5 – 2.5 mm ²

Connection

ON/OFF wiring
+ Push button

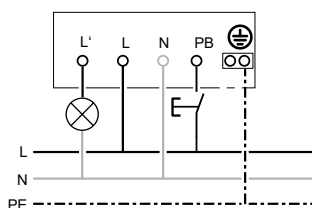

Master/slave wiring
(max. slave ≤ 10)

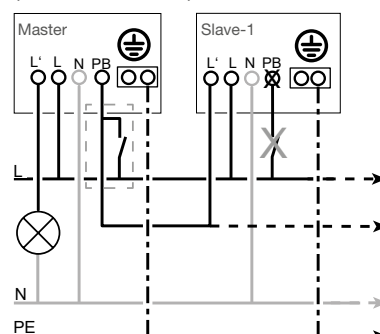

DALI cabling system
Slave < 10 devices (EER5XX)

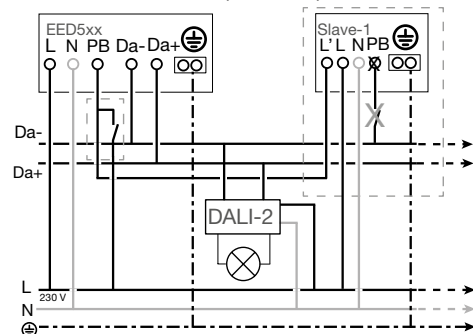

Corridor version



Special corridor motion detector

- For spaces requiring modern, high-performance equipment
- Can be adjusted with the EE807 remote control
- Controlled with the EE808 remote control
- Can function as both master and slave
- Zero-crossing contact compatible with LED loads
- LED status visible on the front of the product

Applications

- Commercial applications
- Hallway
- Multi-residential
- Stairs
- High traffic areas

Product features

	EER505/EER515	TXD505/TXC515	EED505/EED515
Motion function	•	•	•
Presence function			
Brightness function	•	•	•
Master function	•	•	•
Slave function	•	•	
Manual override via push button	•		•

Options

Description	Mounting	Technology	Cat. ref.
Corridor motion detector 30 x 5 m ON/OFF flush mounted	Flush mounted	ON/OFF	EER505
Corridor motion detector 30 x 5 m ON/OFF surface mounted	Surface mounted	ON/OFF	EER515
Corridor motion detector 30 x 5 m KNX \mathbf{e} / \mathbf{S} flush mounted	Flush mounted	KNX \mathbf{e} / \mathbf{S}	TXD505
Corridor motion detector 30 x 5 m KNX \mathbf{e} / \mathbf{S} surface mounted	Surface mounted	KNX \mathbf{e} / \mathbf{S}	TXC515
Corridor motion detector 30 x 5 m DALI 2 flush mounted	Flush mounted	DALI 2	EED505
Corridor motion detector 30 x 5 m DALI 2 surface mounted	Surface mounted	DALI 2	EED515

Hole diameter

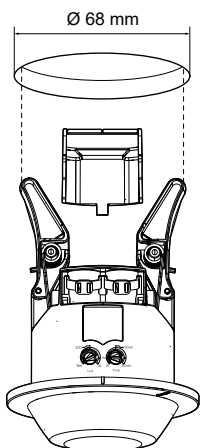

Detection zone

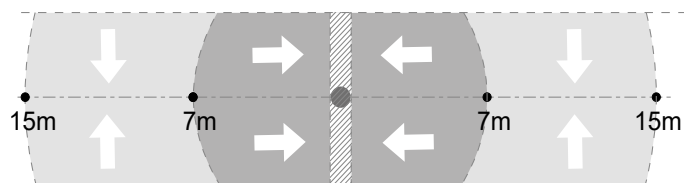

Technical specifications

	EER505/EER515	TXD505/TXC515	EED505/EED515
Supply voltage	230 V ~, +10%/-15% 240 V ~, +6/-6% 50/60 Hz	-	230 V ~, +10%/-15% 240 V ~, +6/-6% 50/60 Hz
Standby power consumption	< 0.5 W	-	< 0.5 W
Switching time Operation Factory setting	Adjustable 5 sec – 60 min - pulse (2s) ~ 15 min	-	-
Response brightness Factory setting	Adjustable 5 – 2000 Lux 500 Lux	-	-
Recommended installation height	2.5 m – 3.5 m	-	-
Maximum installation height	4 m	-	-
Detection zone motion diameter (fitting height 2.5 m) Perpendicular to the detector Frontal movement towards the detector	30 x 5 m 14 x 5 m	-	-
Detection angle	~ 360°	-	-
Cable length from the first to the last device	max. 50 m	-	-
Number of slave devices per master	max. 10	-	-
Contact power 230 V incandescent halogen lamp LED/compact fluorescent lamps Electrical transformer Electronic transformer Parallel compensated fluorescent tubes Fluorescent tubes with electronic ballast	10 A 2000 W 20 x 20 W (400 W) 1500 VA 1500 W 1000 W/130µF 1000 W	- - - - - - -	- - - - - - -
Number of DALI devices	-	-	max. 24
DALI information Rated DALI voltage Guaranteed current Maximum current	- - -	- - -	16 V 48 mA 250 mA
KNX information Configuration mode Power supply KNX rated voltage Current consumption	- - - -	EASY/ETS Via bus 30 V DC Max. 10 mA	- - - -
Operating temperature	-5°C to +45°C	-	-
Storage/transport temperature	-20°C to +70°C	-	-
Ingress/Impact Protection and Protection Class	IP41/IK 04 II	-	-
Dimensions Flush mounted version (Ø x H) Surface mounted version (Ø x H)	Ø 85 x 75.9 mm Ø 105 x 59.7 mm	-	-
Terminal capacity Screwless terminals (loop through)	0.5 – 2.5 mm ²	-	0.5 – 2.5 mm ²

Connection

ON/OFF wiring

+ Push button

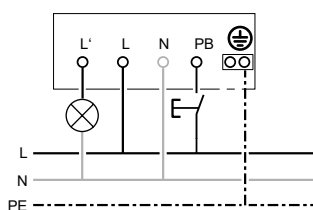

Master/slave wiring

(max. slave ≤ 10)

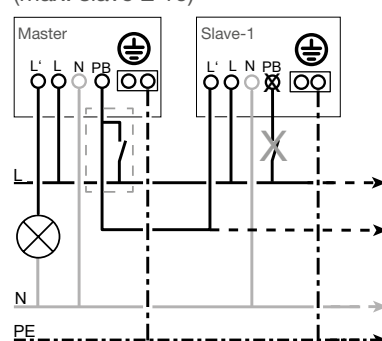

DALI cabling system

Slave < 10 devices (EER5XX)

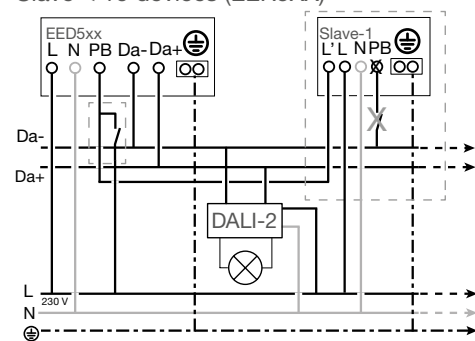

Version for high ceilings



Special corridor motion detector

- For spaces requiring modern, high-performance equipment.
- Can be adjusted with the EE807 remote control
- Controlled with the EE808 remote control
- Can function as both master and slave
- Zero-crossing contact compatible with LED loads
- LED status visible on the front of the product

Applications

- Commercial applications
- High ceilings
- Storage warehouse

Product features

	EER518	TXC518	EED518
Motion function	•	•	•
Presence function			
Brightness function	•	•	•
Master function	•	•	•
Slave function	•	•	
Manual override via push button	•		•

Options

Description	Mounting	Technology	Cat. ref.
Motion detector for high ceilings 22 x 12 m, ON/OFF surface mounted	Flush mounted	ON/OFF	EER518
Motion detector for high ceilings 22 x 12 m KNX ^e / S surface mounted	Surface mounted	KNX ^e / S	TXC518
Motion detector for high ceilings 22 x 12 m, DALI 2 surface mounted	Surface mounted	DALI 2	EED518

Hole diameter

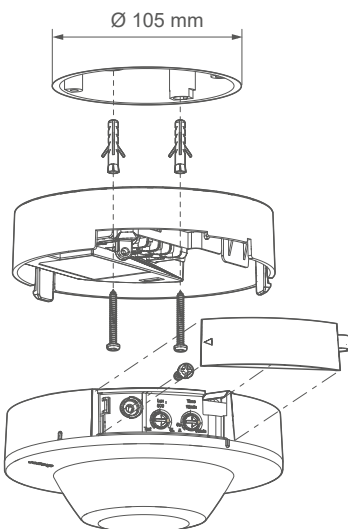

Detection zone

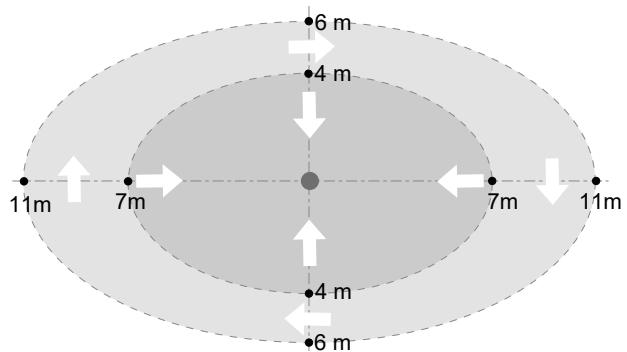

Technical specifications

	EER518	TXC518	EED518
Supply voltage	230 V ~, +10%/-15% 240 V ~, +6/-6% 50/60 Hz	-	230 V ~, +10%/-15% 240 V ~, +6/-6% 50/60 Hz
Standby power consumption	< 0.5 W	-	< 0.5 W
Switching time Operation Factory setting	Adjustable 5 sec – 60 min - pulse (2s) ~ 15 min	-	-
Response brightness Factory setting	Adjustable 5 – 2000 Lux 500 Lux	-	-
Recommended installation height	6 m – 9 m	-	-
Maximum installation height	10 m	-	-
Detection zone motion diameter (fitting height 2.5 m) Perpendicular to the detector Frontal movement towards the detector	22 x 12 m 14 x 8 m	-	-
Detection angle	~ 360°	-	-
Cable length from the first to the last device	max. 50 m	-	-
Number of slave devices per master	max. 10	-	-
Contact power 230 V incandescent halogen lamp LED/compact fluorescent lamps Electrical transformer Electronic transformer Parallel compensated fluorescent tubes Fluorescent tubes with electronic ballast	10 A 2000 W 20 x 20 W (400 W) 1500 VA 1500 W 1000 W/130µF 1000 W	- - - - - - -	- - - - - -
Number of DALI devices	-	-	max. 24
DALI information Rated DALI voltage Guaranteed current Maximum current	- - -	- - -	16 V 48 mA 250 mA
KNX information Configuration mode Power supply KNX rated voltage Current consumption	- - - -	e/s Via bus 30 V DC Max. 10 mA	- - - -
Operating temperature	-5°C to +45°C	-	-
Storage/transport temperature	-20°C to +70°C	-	-
Ingress/Impact Protection and Protection Class	IP41/IK 04 II	-	-
Dimensions Surface mounted version (Ø x H)	Ø 105 x 59.7 mm	-	-
Terminal capacity Screwless terminals (loop through)	0.5 – 2.5 mm ²	-	0.5 – 2.5 mm ²

Connection

ON/OFF wiring
+ Push button

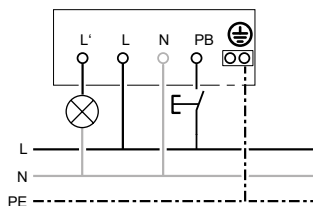

Master/slave wiring

(max. slave ≤ 10)

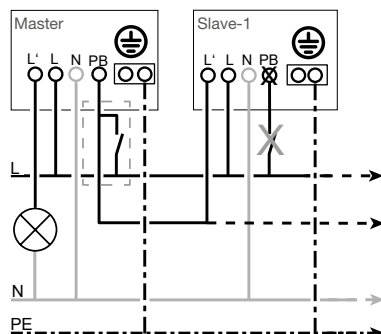

DALI cabling system

Slave < 10 devices (EER5XX)

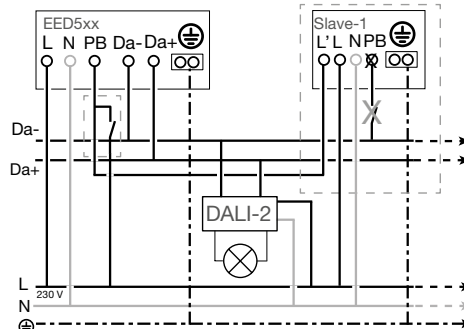

gallery wall mounted version



Special corridor motion detector

- For spaces requiring modern, high-performance equipment.
- Available in master and slave versions
- LED status visible on the front of the product
- Adjustable at the front of the detector
- Compatible with plates from the gallery fittings range

Applications

- Commercial applications
- Hallway
- Multi-residential
- Stairs
- High traffic areas

Product features

	WXF051	WXF052	WXF054	WXT501	WXT505
Motion function	•	•	•	•	•
Presence function				•	•
Brightness function	•	•	•	•	•
Master function	•	•		•	•
Slave function	•	•	•	•	•
Manual override via push button	•	•			

Options

Description	Mounting	Technology	Cat. ref.
gallery wall mounted motion detector, ON/OFF 3 wires	Surface mounted or flush mounted	ON/OFF	WXF051
gallery wall mounted motion detector, ON/OFF 2 wires	Surface mounted or flush mounted	ON/OFF	WXF052
gallery wall mounted motion detector, stairwell, slave WXF051 or BP timer	Surface mounted or flush mounted	ON/OFF	WXF054
Gallery wall mounted motion detector, KNX 1.10 m	Surface mounted or flush mounted	KNXe / S	WXT501
Gallery wall mounted motion detector, KNX 2.20 m	Surface mounted or flush mounted	KNXe / S	WXT505

Detection zone

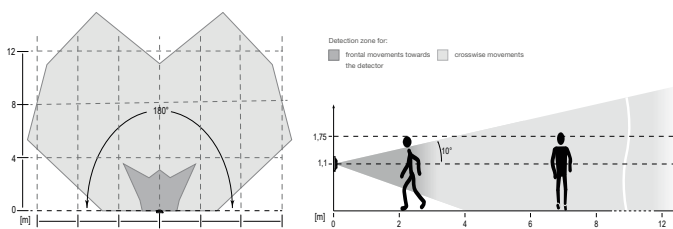

Detection zone of the motion detector for a fitting height of 1.1 m.

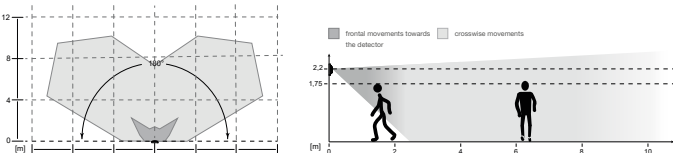

Detection zone of the motion detector for a fitting height of 2.2 m.

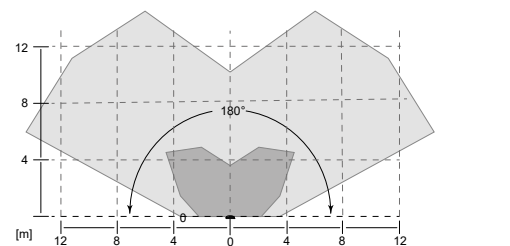

Detection zone of the motion detector for a nominal fitting height of 1.1 m.

Technical specifications

	WX051	WXF052	WXF054	WXT501/WXT505
Supply voltage	230 V ~, +10%/-15% 240 V ~, +6/-6% 50/60 Hz			-
Standby power consumption	< 0.2 W	< 0.2 W	< 0.3 W	< 0.5 W
Switching time Operation	Adjustable 10 sec – 30 min - pulse (200 ms)		-	Adjustable 15 sec – 10 min - pulse (2 s)
Response brightness	Adjustable 5 – 1000 Lux			
Recommended installation height	1.1 m			1.1 m (WXT501) 2.2 m (WXT505)
Motion detection zone Fitting height 1.1 m Fitting height 2.2 m	12 x 16 m	12 x 16 m	12 x 16 m	12 x 16 m (WXT501) 8 x 12 m (WXT505)
Detection angle	~ 90 – 180°			
Cable length from the first to the last device	max. 50 m			-
Number of slave devices per master	Unlimited		-	Unlimited
Contact power 230 V incandescent halogen lamp LED/compact fluorescent lamps Electrical transformer Electronic transformer Parallel compensated fluorescent tubes Fluorescent tubes with electronic ballast	10 A 20 to 300 W 3 to 70 W	10 A 1500 W 400 W	- - - - - -	- - - - - -
KNX information Configuration mode Power supply KNX rated voltage Current consumption	- - - -	- - - -	- - - -	e / S Via bus 30 V DC Max. 10 mA
Operating temperature	-5°C to +45°C			5°C to +45°C
Storage/transport temperature	-20°C to +60°C			-20°C to +70°C
Ingress Protection (IP) Protection class	IP20			IP20 III
Dimensions Surface mounted version (W x H x D)	45 x 44 x 54 mm			45 x 44 x 28 mm
Cross section Screw terminals Rigid Flexible	1 x 1.5 – 2.5 mm ² 2 x 1.5 mm ² 1 x 1.5 – 2.5 mm ²			-

Connection

ON/OFF wiring
+ Push button

Master/slave wiring

Timer wiring

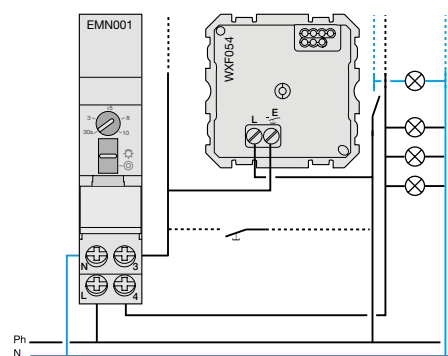
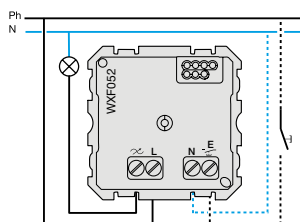
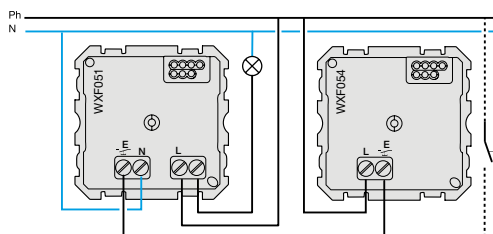
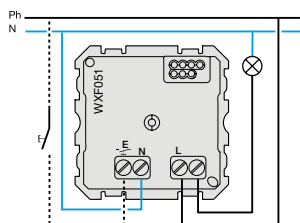

essensya wall mounted version



Special corridor motion detector

- For spaces requiring modern, high-performance equipment.
- Available in master and slave versions
- LED status visible on the front of the product
- Adjustable at the front of the detector
- Compatible with plates from the essensya wiring accessories range

Applications

- Commercial applications
- Hallway
- Multi-residential
- Stairs
- High traffic areas

Product features

	WE052(T)	WXF053(T)	WXE054(T)
Motion function	•	•	•
Presence function			•
Brightness function	•	•	•
Master function	•	•	•
Slave function	•	•	•
Manual override via push button	•		•

Options

Description	Colour	Mounting	Technology	Cat. ref.
essensya wall mounted motion detector, ON/OFF 2 wires	White	Surface mounted or flush mounted	ON/OFF	WE052
	Titanium			WE052T
essensya wall mounted motion detector, ON/OFF 3 wires	White			WE053
	Titanium	WE053T		
essensya wall mounted motion detector, stairwell, slave WE053 or BP timer	White	WE054		
	Titanium	WE054T		

Detection zone

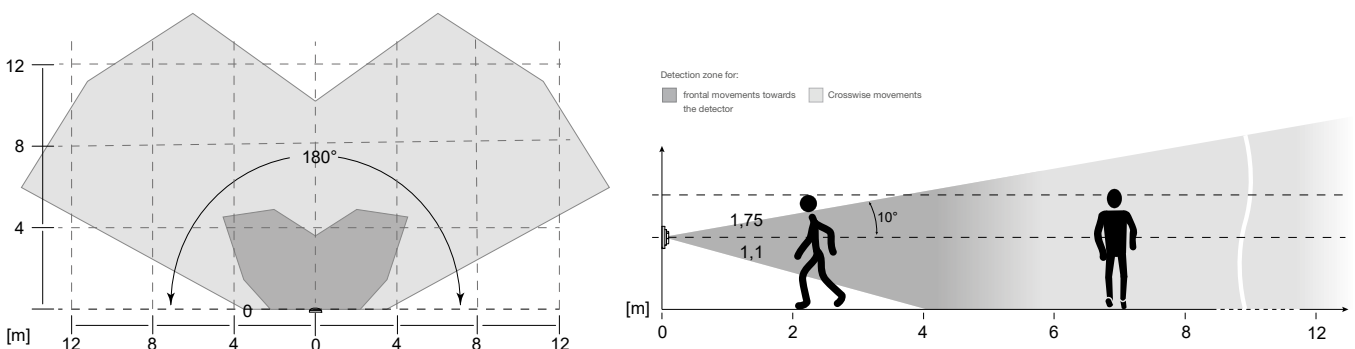

Detection zone of the motion detector for a nominal fitting height of 1.1 m.

Technical specifications

	WE052(T)	WE053(T)	WE054(T)
Supply voltage	230 V ~, +10%/-15% 50/60 Hz		
Standby power consumption	< 0.2 W	< 0.2 W	< 0.3 W
Switching time Operation	Adjustable 10 sec – 30 min - pulse (200 ms)		
Response brightness	Adjustable 5 – 1000 Lux		
Recommended installation height	1.1 m		
Motion detection zone Fitting height 1.1 m	12 x 16 m		
Detection angle	~90 – 180°		
Cable length from the first to the last device	max. 50 m-		
Number of slave devices per master	Unlimited		-
Contact power 230 V incandescent halogen lamp LED/compact fluorescent lamps Electrical transformer Electronic transformer Parallel compensated fluorescent tubes Fluorescent tubes with electronic ballast	10 A 20 to 300 W 3 to 70 W 20 to 300 VA 20 to 300 W 20 to 300 W 20 to 300 W	10 A 1500 W 400 W 1500 VA 1500 W 300 VA 1500 W	- - - - - - -
Operating temperature	-5°C to +45°C		
Storage/transport temperature	-20°C to +60°C		
Ingress Protection (IP) Protection class	IP20 -		
Dimensions Surface mounted version (W x H x D)	70.5 x 70.5 x 54 mm		
Cross section Screw terminals Rigid Flexible	1 x 1.5 – 2.5 mm ² 2 x 1.5 mm ² 1 x 1.5 – 2.5 mm ²		

Connection

ON/OFF wiring
+ forcing button

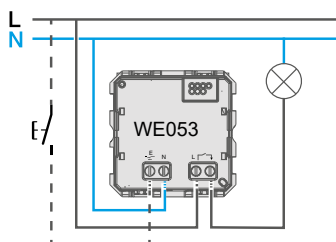
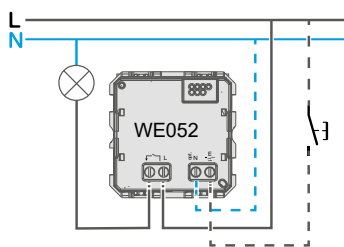

Master/slave wiring

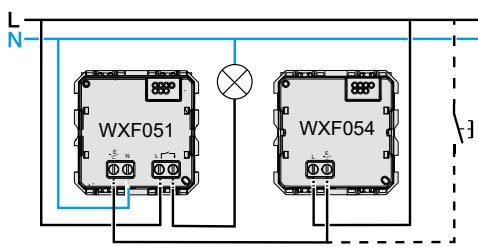

Timer wiring

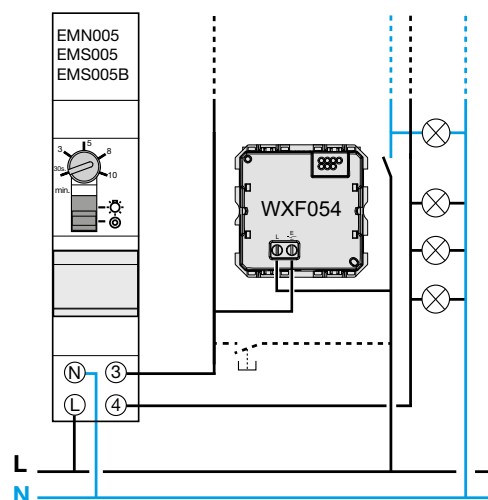

Standard wall mounted version



IP55 motion detector

- For outside spaces or areas subject to high humidity levels
- Can function as both master and slave
- Adjustable detection angle
- Can be angled left or right
- Screwless through terminal
- Mounting accessories
 - Corner white EE825 - Anthracite EE826
 - Ceiling White EE827 - Anthracite EE828

Applications

- Commercial and residential applications
- Outside use
- Storage warehouse
- Parking areas
- High traffic areas

Product features

	EE820/EE821	EE830/EE831	EE840/EE841
Motion function	•	•	•
Presence function			
Brightness function	•	•	•
Master function			
Slave function	•	•	•
Manual override via push button			

Options

Description	Mounting	Technology	Cat. ref.
Standard IP55 wall mounted motion detector, 140° ON/OFF	Wall mounted	ON/OFF	EE820/EE821
Standard IP55 wall mounted motion detector, 200° ON/OFF			EE830/EE831
Standard IP55 wall mounted motion detector, 360° ON/OFF			EE840/EE841

Detection zone

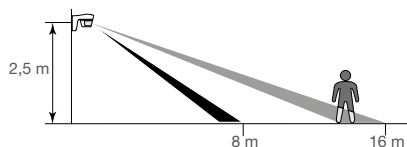

The optimal installation height is 2.5 m.
The detection field must remain free.

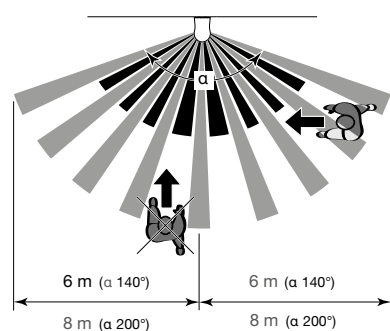

EE820/821: $\alpha = 140^\circ$ EE830/831: $\alpha = 200^\circ$

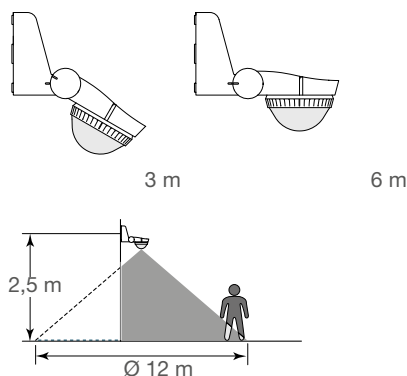

The optimal installation height is 2.5 m.

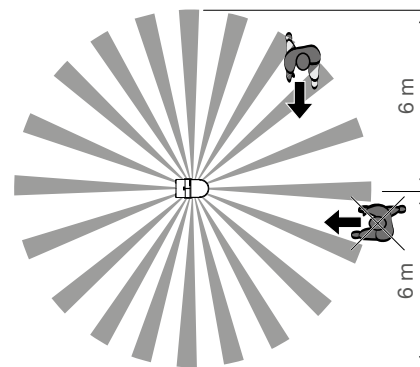

EE840/841: $\alpha = 360^\circ$

Technical specifications

	EE820/EE821	EE830/EE831	EE840/EE841
Supply voltage	230 V ~, +10%/-15% 240 V ~, +6/-6% 50/60 Hz		230 V ~, +10%/-15% 50/60 Hz
Standby power consumption	1.2 W		
Switching time Operation	Adjustable 5 sec – 15 min - pulse		
Response brightness	Adjustable 5 – 1000 Lux		
Recommended installation height	2.5 m		
Motion detection zone (Fitting height 2.5 m) Detector tilt at 0° Detector tilt at 30°	12 x 8 m 12 x 16 m	16 x 8 m 16 x 16 m	
Detection angle	~ 140°	~ 200°	~ 360°
Contact power 230 V incandescent halogen lamp LED/compact fluorescent lamps Electrical transformer Electronic transformer Parallel compensated fluorescent tubes Fluorescent tubes with electronic ballast	10 A 1500 W 10 to 20 W (200 W) 1500 VA 1500 VA 290 W/32 µF 580 W		
Operating temperature	-20°C to +55°C		
Storage/transport temperature	-20°C to +60°C		
Ingress/Impact Protection and Protection Class	IP55/IK04 II		
Dimensions Surface mounted version (W x H x D)	127 x 83 x 97 mm	153 x 91 x 64 mm	
Terminal capacity Screwless terminals (loop through)	Rigid 1.5 mm ²		

Connection

ON/OFF wiring

EE820/EE821 EE830/EE831

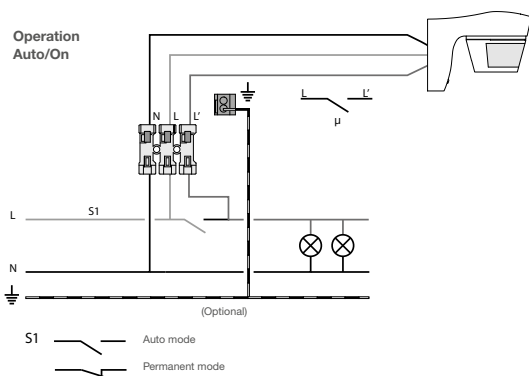
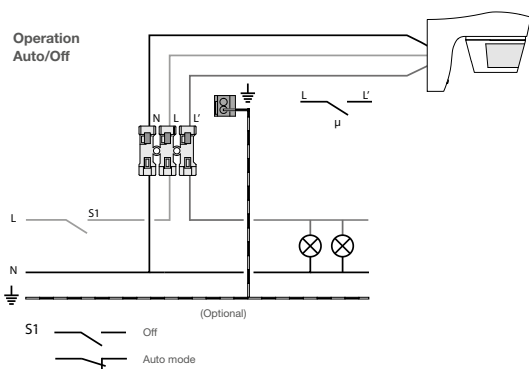

ON/OFF wiring

EE840/EE841

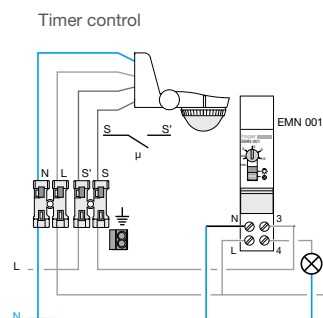
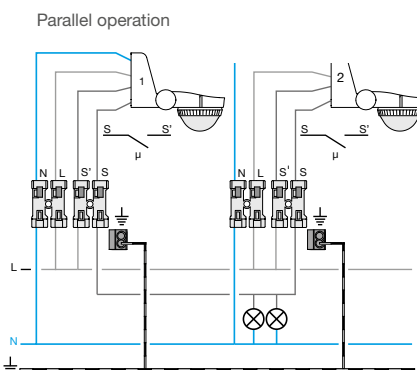
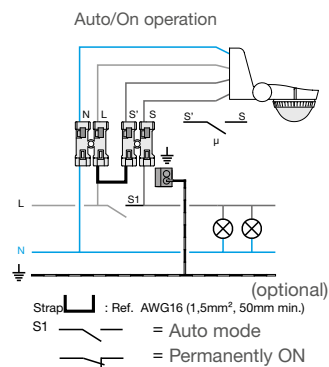
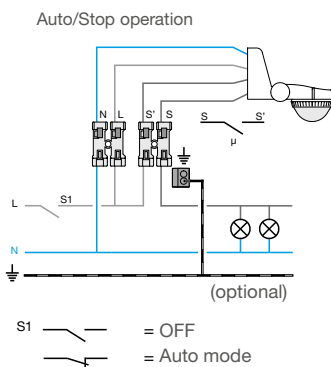

Advanced wall mounted detector



IP55 motion detector

- For outside spaces or areas subject to high humidity levels
- Can be adjusted with the EE806 remote control
- Can function as both master and slave
- Adjustable detection angle
- Can be angled up/down and left/right
- Screwless through terminal
- Mounting accessories
 - Corner EE855/EE856

Applications

- Commercial and residential applications
- Outside use
- Storage warehouse
- Parking areas
- High traffic areas

Product features

	EE850	EE860/EE861	EE870/EE871	TRE500	TRE700
Motion function	•	•	•	•	•
Presence function					
Brightness function	•	•	•	•	•
Master function				•	•
Slave function	•	•	•	•	•
Manual override via push button					

Options

Description	Mounting	Technology	Cat. ref.
Standard IP55 wall mounted motion detector, 140° ON/OFF	Wall mounted	ON/OFF	EE850
Standard IP55 wall mounted motion detector, 200° ON/OFF		ON/OFF	EE860/EE861
Standard IP55 wall mounted motion detector, 220/ 230° ON/OFF		ON/OFF	EE870/EE871
Standard IP55 wall mounted motion detector, 220/ 230° KNX radio/Q		KNX radio (e / S / Q)	TRE500
Standard IP55 wall mounted motion detector kit 220/230° radio/Q + control module 1 radio output			

Detection zone

EE850/860/861

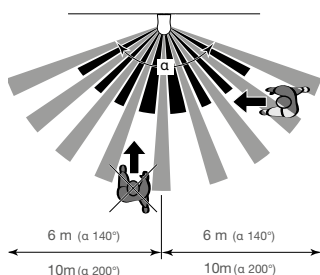
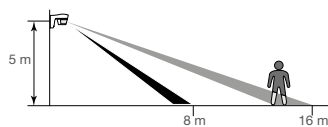

EE870/871

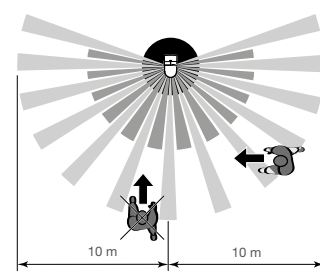
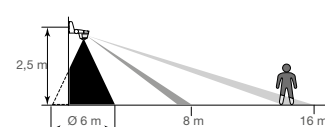

TRE500/TRE501/TRE700

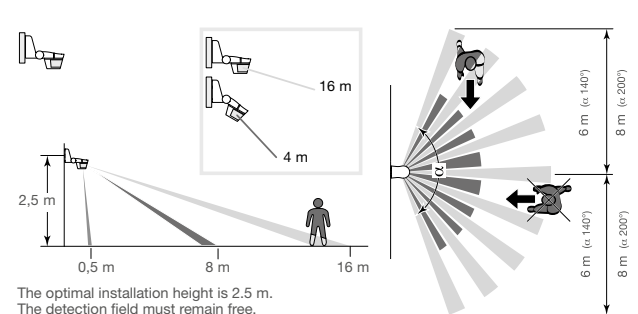

Technical specifications

	EE850	EE860/EE861	EE870/EE871	TRE500
Supply voltage	230 V ~, +10%/-15% 50/60 Hz	230 V ~, +10%/-15% 240 V ~, +6/-6% 50/60 Hz	230 V ~, +10%/-15% 50/60 Hz	3 x 1.5 V AAA
Standby power consumption	1.2 W			
Switching time Operation	Adjustable 5 sec – 30 min - pulse			5 sec – 15 min - pulse
Response brightness	Adjustable 5 – 1000 Lux			
Recommended installation height	2.5 m			
Motion detection zone (Fitting height 2.5 m) Detector tilt at 0° Detector tilt at 30°	12 x 8 m 12 x 16 m	20 x 8 m 20 x 16 m		12 x 8 m 12 x 16 m
Detection angle	~ 140°	~ 220°	~ 360°	~ 220°
Contact power 230 V incandescent halogen lamp LED/compact fluorescent lamps Electrical transformer Electronic transformer Parallel compensated fluorescent tubes Fluorescent tubes with electronic ballast	10 A 2300 W 10 to 20 W (200 W) 1500 VA 1500 VA 400 W/45 µF 580 W			
KNX information Configuration mode Power supply KNX rated voltage Current consumption	-			e / S Internal (radio product)
Operating temperature	-20°C to +55°C			
Storage/transport temperature	-20°C to +60°C			
Ingress/Impact Protection and Protection Class	IP55/IK06 II			
Dimensions Surface mounted version (W x H x D)	153 x 91 x 139 mm			153 x 91 x 130 mm
Terminal capacity Screwless terminals (loop through)	Rigid 1.5 mm ²			

Connection

ON/OFF wiring EE850/EE860/EE861/EE870/EE871

Auto/Stop operation

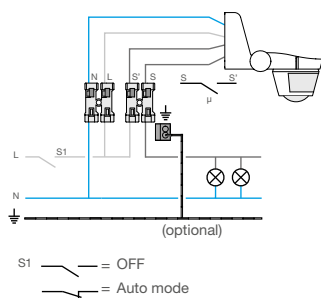

Auto/On operation

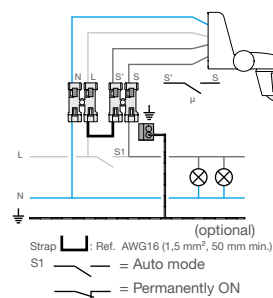

Parallel operation

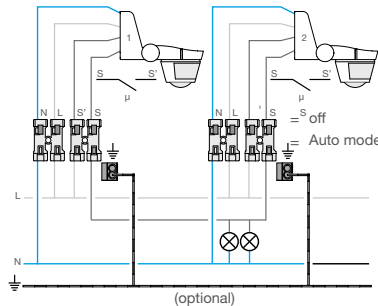

Timer control

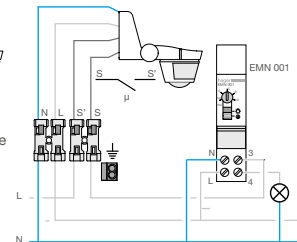



Hager Electro S.A.S

132 Boulevard d'Europe BP3
67215 Obernai Cedex
France

Tel: +33 (0) 3 88 49 50 50

hager.com/intl-en



23EN_AF_BRO_MDETEC