

**Tarifa 712**

**Series de  
mecanismos**

**Marzo 2023**

**:hager**

# Construyendo juntos el mundo eléctrico del mañana



# Aceleremos nuestra transición energética hacia más energías renovables, movilidad eléctrica y gestión energética.



**Daniel Hager**  
Hager Group CEO

## **Apreciados clientes, colaboradores y amigos del Grupo Hager.**

Vivimos tiempos de cambio. El nuevo entorno geopolítico y de mercado nos hace darnos cuenta, aún más, de lo valiosos que son nuestros recursos y de lo importante que es la energía para nuestro modo de vida.

Los últimos acontecimientos nos obligan a acelerar aún más nuestra transición energética. Más energías renovables, más movilidad eléctrica, más gestión de la energía. Ahora más que nunca entendemos lo que significa realmente “el futuro será eléctrico”. Este cambio necesario es una posibilidad para toda nuestra industria.

La escasez de energía nos hace apreciar la eficiencia y la gestión energética de una nueva manera. Nuestra industria desempeña un papel esencial a la hora de proporcionar los productos y soluciones para superar estos retos. Estamos en el centro de la configuración del mundo eléctrico del mañana, un mundo en el que el éxito a largo plazo va de la mano de prácticas sostenibles. Los retos actuales nos hacen estar aún más decididos a iniciar este cambio nosotros mismos, junto con nuestros colaboradores y clientes.

Hay una fuerza especial en unirnos, en encontrar puntos en común, en hablar unos con otros y

entender qué es lo que más necesita la otra parte y cómo podemos apoyarnos mutuamente. Juntos formamos una red fuerte, capaz de dominar los retos que nos esperan ahora y en el futuro. Estoy convencido de ello.

Sigo siendo optimista. Los retos son inmensos. Pero no conozco ningún otro sector para el que esta era de cambio sea una oportunidad tan grande. Tenemos en nuestras manos demostrar nuestra valía y construir un gran futuro para nuestra industria.

Les saluda atentamente,  
Daniel Hager

# Nuestra visión

La visión de Hager Group es hacer que la vida en nuestro planeta sea más segura, limpia y placentera a través de soluciones de infraestructura eléctrica ingeniosas, sostenibles y confiables para todo tipo de edificios.

## Nuestro mundo hoy y mañana

Constantemente reinventamos la electricidad para satisfacer las crecientes demandas de energía del mundo con productos y soluciones de mejor rendimiento y menor consumo. También avanzamos al ritmo de la tecnología a medida que el uso de la electricidad se vuelve “más inteligente” en los hogares y edificios y, sin embargo, una cosa perdura en todo este cambio rápido: siempre produciremos y proporcionaremos soluciones y productos seguros y simples. Es lo que hemos estado haciendo durante más de 65 años.

## Lo suficientemente grande para importar, lo suficientemente pequeño para preocuparse

Como actor global, actuamos en todos los ámbitos del mundo de la infraestructura eléctrica; distribución de energía, gestión de energía, movilidad eléctrica, gestión del cableado, accesorios de cableado, hogares conectados y automatizados. Cubrimos todas tus necesidades y nuestros productos y soluciones son casi siempre personalizables si lo deseas.

Nos hemos ganado una reputación de productos fabricados en Europa de alta calidad, escalables y de confianza, probados y preparados para todo tipo de edificios, grandes y pequeños, para que tú y tus clientes podáis estar seguros de que tus instalaciones resistirán a largo plazo.

## Enfoque generacional

Como empresa familiar que se enorgullece de que sea fácil trabajar con ella, encontrar soluciones con un espíritu de colaboración, cooperación y creación conjunta es la forma en que disfrutamos trabajando a diario, es la forma en que sentimos que se hace mejor el negocio y la forma en que acabamos por lograr juntos mejores resultados. Porque nos impulsa un estilo emprendedor en un mundo en el que las personas como tú nos importan tanto, que estaremos a tu lado en tus proyectos y más allá. Pase lo que pase, Hager hará un esfuerzo adicional para que cumplas con tus requisitos.

## Mirando hacia el futuro

Estamos invirtiendo a gran escala para garantizar que siempre obtengas lo mejor de nosotros con grandes inversiones en capacidad de producción y en centros de distribución, pero también desarrollando nuevos y emocionantes productos en nuestros nuevos centros de investigación y desarrollo para afrontar los retos conjuntos de consumo energético y medio ambiente.

Por mucho que cambie el mundo, nunca cambiaremos nuestro enfoque hacia ti, nuestros clientes, siempre estaremos con nuestros centros de soporte y aprendizaje habituales disponibles continuamente para ti. For you, with you.

# hagergroup

Hager Group es un proveedor líder de soluciones y servicios para instalaciones eléctricas en edificios residenciales, comerciales e industriales con 12.900 empleados que generan 2.800 millones de euros en ventas (2022). Los componentes y las soluciones se producen en 20 ubicaciones en todo el mundo y se distribuyen a clientes en más de 100 países.

## Miembros de Hager Group

**:hager**

**B.**  
Berker

**ELCOM.**

ENERGY STORAGE  
**E3A DC**

**B. BOCCHIOTTI**

**B. IBOCO**

# En todos tus proyectos estamos a tu lado.

Para llevar a cabo tus proyectos, un equipo de expertos Hager te acompaña antes y después de la venta para ayudarte a establecer tus presupuestos y responder a tus preguntas. Nuestros softwares y herramientas online te facilitan tus tareas diarias.

## Explora la web [hager.es](https://www.hager.es)

El mundo digital está en constante movimiento y en Hager evolucionamos con él. Por eso hemos desarrollado una nueva web que se adapta a ti. Hemos puesto gran énfasis en la simplicidad y la facilidad de uso. Echa un vistazo a las diferentes secciones:



### Soporte

Asistencia técnica, consultas generales, por teléfono, formulario o email



Contenidos personalizados según tu perfil profesional o tipo de proyecto



### Videos

Sobre productos, soluciones, empresa, eventos, obras



### Un espacio para la inspiración

Obras de referencia, testimonios, galería de diseños, eventos, blog



### Documentación

Descarga nuestras tarifas, documentos, fichas técnicas



### catálogo, softwares y apps

Estés donde estés, Hager te ayuda y te facilita tu día a día



### Programas formativos

Video tutoriales, webinars

For you, with you.

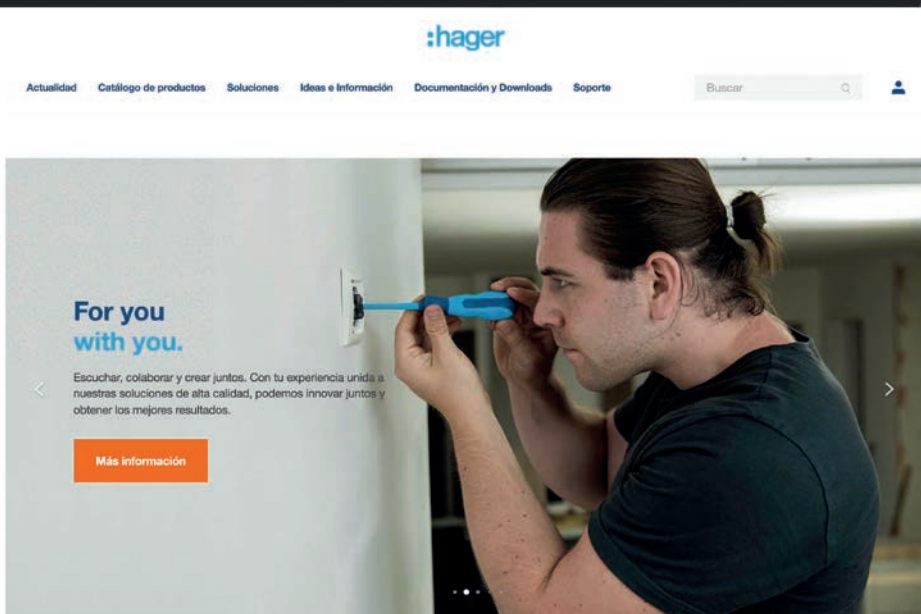

**Hager, tu proveedor de soluciones eléctricas para edificios residenciales, terciarios e industriales.**

## En la red [/HagerSpain](#)

Visita en nuestro canal youtube nuestras soluciones y tutoriales sobre como utilizar/configurar/installar nuestros productos.

Visita nuestros canales en facebook instagram y LinkedIn, forma parte de nuestra comunidad e interactúa con nosotros.

 YouTube  facebook  Instagram  Linked in

# Toma el control de tu día a día

Tras la instalación, el control de las múltiples funcionalidades de confort, alarma, y ahorro de energía se pueden pilotar vía App, accediendo con un smartphone, tablet, ordenador... Un hogar conectado al alcance de toda la familia. Por otra parte, nuestros softwares para el estudio, diseño y cálculo de cualquier caja de abonado o cuadro de distribución te serán de gran ayuda en todos tus proyectos.

## Hagercad.project Proyectar, optimizar

El software de Hager para la concepción y cálculo de cuadros eléctricos hasta 4.000 A, es una herramienta completa e innovadora que le garantiza total compatibilidad, seguridad y rapidez de ejecución. El acabado más profesional, que te permitirá fácilmente proyectar, optimizar y convencer.

[hager.es/hagercad](http://hager.es/hagercad)

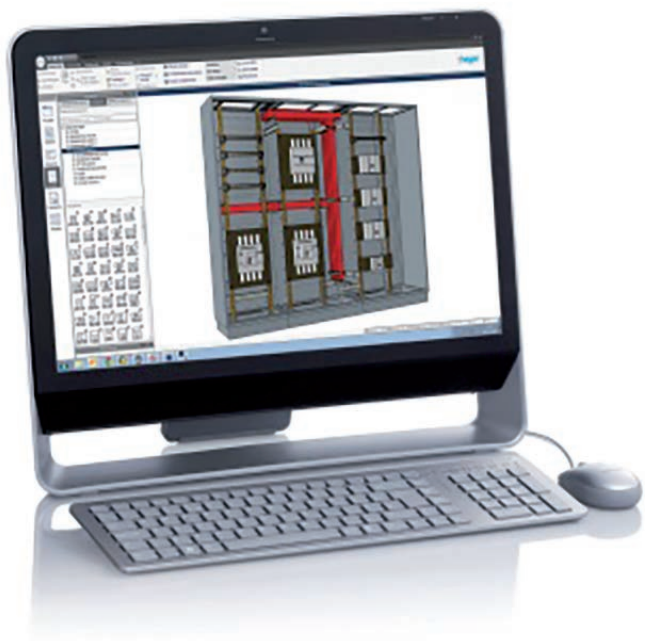

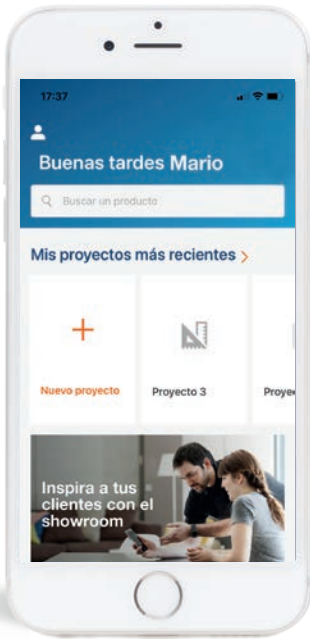

## Hager Ready

La App de Hager Hager Ready, llega para ahorrarte tiempo en tu trabajo. Accede de forma rápida al e-catálogo, crea un espacio donde organizar y compartir tus proyectos, consulta toda nuestra documentación o contacta con la asistencia técnica tan solo pulsando un botón.

**Toda la información en tus manos. Descarga la App y consulta nuestro catálogo, documentos técnicos, documentos, hojas de instrucciones, guías de selección, videos... Configura el cuadro eléctrico e imprime tus etiquetas. Mantén tu negocio avanzando con las herramientas que necesitas a tu alcance.**



**Descarga de la app gratuita**



## Hager Mood. Programa fácilmente tus horarios

Con la nueva aplicación Hager Mood, se pueden programar los horarios desde cualquier lugar. Se puede poner en marcha el programador horario digital inmediatamente después de instalarlo. También se pueden enviar los programas al dispositivo en cualquier momento por Bluetooth.

**Conecta, programa, sincroniza con los dispositivos instalados y envía datos a la nube de Hager para su almacenamiento seguro. También puedes dar acceso y permisos de edición a tus clientes.**

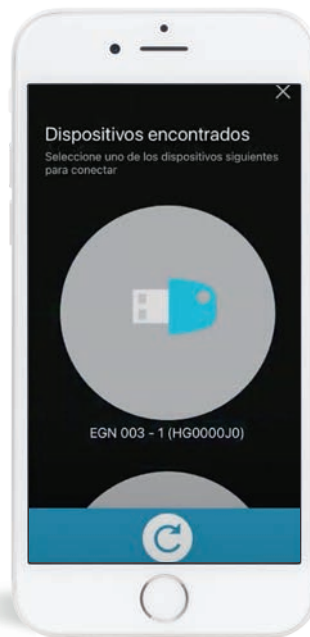

**Descarga de la app gratuita**

# Series Hager.

## Visualiza tu acabado.

App para la realización y envío por correo electrónico de presupuestos de series de mecanismos y simulación virtual de cómo queda el acabado en la instalación.



### Una App que te ahorra trabajo

Es posible escoger estancia por estancia el acabado deseado, así como las funcionalidades necesarias. Al final del proceso se obtiene un listado de referencias, descripciones y precios que te permiten tener una valoración rápida de la instalación acompañada de la documentación técnica de las series escogidas en formato .pdf. El fichero .pdf resultante puede enviarse por correo electrónico de forma muy sencilla desde la aplicación.



Descarga de la app gratuita



Versión portable en [hager.es/serieshager](http://hager.es/serieshager)

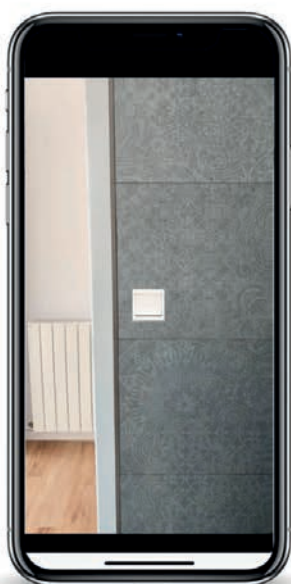

Simulación de cómo quedará el mecanismo escogido en la estancia.



Ficha técnica del mecanismo con sus características.



Descripción e imágenes del mecanismo y sus características.

Soluciones Hager.  
Terciario y residencial.

# Contigo, en todos tus proyectos.

For you, **with you.**

Para nosotros tú eres lo primero.  
Para llevar a cabo tus proyectos,  
te acompañamos antes y después  
de la venta para ayudarte a  
establecer tus presupuestos  
y responder a tus preguntas.

[hager.com/es/soporte](https://www.hager.com/es/soporte)

**:hager**

# Soluciones adaptadas.

Del diseño a la instalación. Nuestras soluciones para residencial y terciario integran la mejor tecnología y permiten mejorar en confort, ahorro energético y seguridad. Calidad y fiabilidad a toda prueba.

## Series lumina

lumina soul / lumina intense



41

## Series berker

berker S.1 / B.3 / B.7 / Q.1 / Q.3 / Q.7 / K.1 / K.5 / R.1 / R.3 / R.8 /  
Serie R.classic / Serie 1930 / Serie 1930 Porzellan made by Rosenthal /  
Serie Glas



61

## Manufaktur

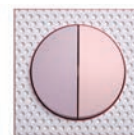

167

## Series técnicas industriales y estancas

berker Integro / cubyko IP55



175

## Guía técnica

Limpieza y cuidado / lumina / Estancas IP44 / Medidas series berker /  
cubyko / Certificados de producto / Materiales y colores



197

## Servicios

Indice de referencias / Condiciones de venta / Mapa delegaciones



219

# berker significa excelencia en el diseño



berker R.1



berker R.3

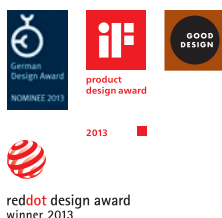

berker R.8



berker B.3



berker Q.1



DESIGN PLUS



berker Q.7



berker R.1 / R.3  
Touch Sensor

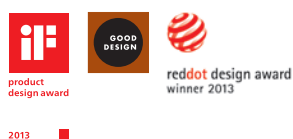

2013 ■



berker TS Sensor



2007 ■



berker TS



Las series de mecanismos berker marcan la diferencia. Al menos esa no sólo es la opinión de muchos clientes, sino también la de los jurados de los numerosos concursos nacionales e internacionales que han ganado una y otra vez.

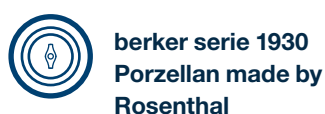

DESIGN PLUS

DESIGN PLUS  
powered by light+building  
2020



2013 ■ 2013 GOLD ■



DESIGN PLUS



DESIGN PLUS  
powered by light+building



**lumina soul**

blanco polar



**lumina intense**

blanco polar  
brillo



plata mate



negro  
mate



**berker S.1**

blanco brillo



blanco polar  
brillo



blanco polar  
mate



aluminio



antracita



**berker B.3**

aluminio /  
blanco polar  
mate



aluminio /  
antracita



aluminio  
dorado\* /  
blanco polar  
mate



aluminio  
negro\* / blanco  
polar mate



aluminio  
marrón\* / blanco  
polar mate



aluminio  
rojo\* / blanco  
polar mate



\* las versiones dorado, negro, marrón y rojo existen también combinadas con embellecedor y tecla antracita

**berker B.7**

blanco polar  
mate



aluminio



antracita



aluminio\*  
blanco polar  
mate



acero\*  
blanco polar  
mate



crystal  
blanco polar  
mate



crystal  
antracita



crystal  
aluminio



\* también combinadas con embellecedor y tecla antracita

**berker Q.1**

blanco  
polar



antracita



aluminio



**berker Q.3**

blanco  
polar



antracita



aluminio



**berker Q.7**

blanco polar / aluminio / antracita



aluminio



acero  
inoxidable

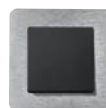

crystal  
blanco



crystal  
negro



pizarra  
natural



hormigón



**berker K.1**

blanco polar



antracita



**berker K.5**

aluminio E6EV1



acero



**berker R.1**

blanco polar brillo



negro brillo



aluminio blanco polar



aluminio negro



acero blanco polar



acero negro



cristal blanco polar



cristal negro



pizarra blanco polar



pizarra negro



hormigón blanco polar



hormigón negro



piel marrón blanco polar



piel marrón negro



madera blanco polar



madera negro



acrílico rojo / blanco polar



acrílico rojo / negro



acrílico naranja / blanco polar



acrílico naranja / negro



**berker R.3**

blanco polar brillo



negro brillo



aluminio blanco polar



aluminio negro



acero blanco polar



acero negro



cristal blanco polar



cristal negro



**berker R.8**

cristal blanco polar



cristal negro



aluminio blanco polar



aluminio negro



acero blanco polar



acero negro



### Serie R.classic

blanco polar  
brillo

negro  
brillo

aluminio  
blanco polar

aluminio  
negro

acero  
blanco polar

acero  
negro

cristal  
blanco polar

cristal  
negro



### Serie 1930

blanco  
polar

negro



### Serie 1930 Porzellan made by Rosenthal

blanco polar  
Porzellan made  
by Rosenthal

negro  
Porzellan made  
by Rosenthal



### Serie Glas

cristal blanco /  
blanco polar

cristal blanco /  
negro

cristal blanco  
polar /  
blanco polar

cristal blanco  
polar / negro



#### Nota:

En instalaciones en paredes de tabique hueco, se recomienda dejar la caja de empotrar enrasada con la pared con el fin de que la instalación de nuestras series de mecanismos se realice de la manera que se han diseñado. Recomendamos el uso de una sierra de corona con avellanador.

lumina intense



# Crea tu propio Estilo

## Más que un estándar

Darle un toque individual a lumina nunca ha sido tan fácil como ahora. La serie de mecanismos lumina intense ofrece tres atractivos colores a escoger, y un diseño de marco completamente nuevo.

Con lumina intense tienes el acabado perfecto para cada ocasión.

¿Por qué no probar algo nuevo?

[hager.es/lumina](http://hager.es/lumina)

**:hager**

blanco polar



		Ref.	Precio
<b>Interruptor</b>	Mecanismo con tecla	WL0010	4,75
	Marco 1 elemento	WL5010	1,16
			<b>5,91</b>
<b>Conmutador</b>	Mecanismo con tecla	WL0020	6,13
	Marco 1 elemento	WL5010	1,16
			<b>7,29</b>
<b>Cruzamiento</b>	Mecanismo con tecla	WL0030	12,21
	Marco 1 elemento	WL5010	1,16
			<b>13,37</b>
<b>Toma SCHUKO</b>	Mecanismo con tapa	WL1060	5,11
	Marco 1 elemento	WL5010	1,16
			<b>6,27</b>
<b>Pulsador</b>	Mecanismo con tecla	WL0110	7,37
	Marco 1 elemento	WL5010	1,16
			<b>8,53</b>
<b>Pulsador timbre</b>	Mecanismo con tecla	WL0110	7,37
	Tecla campana	WL6010	1,92
	Marco 1 elemento	WL5010	1,16
			<b>10,45</b>
<b>Doble interruptor</b>	Mecanismo con teclas	WL0040	8,07
	Marco 1 elemento	WL5010	1,16
			<b>9,23</b>
<b>Doble conmutador</b>	Mecanismo con teclas	WL0050	9,01
	Marco 1 elemento	WL5010	1,16
			<b>10,17</b>
<b>Doble interruptor persianas</b>	Mecanismo con teclas	WL0310	19,72
	Marco 1 elemento	WL5010	1,16
			<b>20,88</b>
<b>Doble pulsador persianas</b>	Mecanismo con teclas	WL0320	20,14
	Marco 1 elemento	WL5010	1,16
			<b>21,30</b>
<b>Toma teléfono</b>	Mecanismo con tapa	WL2010	12,26
	Marco 1 elemento	WL5010	1,16
			<b>13,42</b>
<b>Toma simple RJ45 cat. 5e</b>	Mecanismo con tapa	WL2110	18,54
	Marco 1 elemento	WL5010	1,16
			<b>19,70</b>
<b>Toma doble RJ45 cat. 5e</b>	Mecanismo con tapa	WL2120	37,06
	Marco 1 elemento	WL5010	1,16
			<b>38,22</b>
<b>Toma TV</b>	Mecanismo con tapa	WL3010	22,77
	Marco 1 elemento	WL5010	1,16
			<b>23,93</b>
<b>Tapa ciega</b>	Mecanismo con tapa	WL7010	7,64
	Marco 1 elemento	WL5010	1,16
			<b>8,80</b>
<b>Regulador rotativo</b>	Mecanismo con tapa	WL4010	61,70
	Marco 1 elemento	WL5010	1,16
			<b>62,86</b>
<b>Marco vertical</b>	2 elementos	WL5120	2,09
	3 elementos	WL5130	3,36
	4 elementos	WL5140	5,98
	5 elementos	WL5150	8,24
<b>Marco horizontal</b>	2 elementos	WL5220	2,09
	3 elementos	WL5230	3,36
	4 elementos	WL5240	5,98
	5 elementos	WL5250	8,24





blanco polar

plata

negro



		Ref.	Precio	Ref.	Precio	Ref.	Precio
<b>Interruptor</b>	Mecanismo con tecla Marco 1 elemento	WL0010	4,75	WL0012	5,99	WL0013	5,99
		WL5510	1,25	WL5512	3,42	WL5513	3,42
			<b>6,00</b>		<b>9,41</b>		<b>9,41</b>
<b>Conmutador</b>	Mecanismo con tecla Marco 1 elemento	WL0020	6,13	WL0022	7,63	WL0023	7,63
		WL5510	1,25	WL5512	3,42	WL5513	3,42
			<b>7,38</b>		<b>11,05</b>		<b>11,05</b>
<b>Cruzamiento</b>	Mecanismo con tecla Marco 1 elemento	WL0030	12,21	WL0032	15,23	WL0033	15,23
		WL5510	1,25	WL5512	3,42	WL5513	3,42
			<b>13,46</b>		<b>18,65</b>		<b>18,65</b>
<b>Toma SCHUKO</b>	Mecanismo con tapa Marco 1 elemento	WL1060	5,11	WL1062	6,30	WL1063	6,30
		WL5510	1,25	WL5512	3,42	WL5513	3,42
			<b>6,36</b>		<b>9,72</b>		<b>9,72</b>
<b>Pulsador</b>	Mecanismo con tecla Marco 1 elemento	WL0110	7,37	WL0112	9,20	WL0113	9,20
		WL5510	1,25	WL5512	3,42	WL5513	3,42
			<b>8,62</b>		<b>12,62</b>		<b>12,62</b>
<b>Pulsador timbre</b>	Mecanismo con tecla Tecla campana Marco 1 elemento	WL0110	7,37	WL0112	9,20	WL0113	9,20
		WL6010	1,92	WL6012	2,44	WL6013	2,44
		WL5510	1,25	WL5512	3,42	WL5513	3,42
			<b>10,54</b>		<b>15,06</b>		<b>15,06</b>
<b>Doble interruptor</b>	Mecanismo con teclas Marco 1 elemento	WL0040	8,07	WL0042	10,18	WL0043	10,18
		WL5510	1,25	WL5512	3,42	WL5513	3,42
			<b>9,32</b>		<b>13,60</b>		<b>13,60</b>
<b>Doble conmutador</b>	Mecanismo con teclas Marco 1 elemento	WL0050	9,01	WL0052	11,25	WL0053	11,25
		WL5510	1,25	WL5512	3,42	WL5513	3,42
			<b>10,26</b>		<b>14,67</b>		<b>14,67</b>
<b>Doble interruptor persianas</b>	Mecanismo con teclas Marco 1 elemento	WL0310	19,72	WL0312	24,59	WL0313	24,59
		WL5510	1,25	WL5512	3,42	WL5513	3,42
			<b>20,97</b>		<b>28,01</b>		<b>28,01</b>
<b>Doble pulsador persianas</b>	Mecanismo con teclas Marco 1 elemento	WL0320	20,14	WL0322	25,42	WL0323	25,42
		WL5510	1,25	WL5512	3,42	WL5513	3,42
			<b>21,39</b>		<b>28,84</b>		<b>28,84</b>
<b>Toma teléfono</b>	Mecanismo con tapa Marco 1 elemento	WL2010	12,26	WL2012	15,29	WL2013	15,29
		WL5510	1,25	WL5512	3,42	WL5513	3,42
			<b>13,51</b>		<b>18,71</b>		<b>18,71</b>
<b>Toma simple RJ45 cat. 5e</b>	Mecanismo con tapa Marco 1 elemento	WL2110	18,54	WL2112	23,38	WL2113	23,38
		WL5510	1,25	WL5512	3,42	WL5513	3,42
			<b>19,79</b>		<b>26,80</b>		<b>26,80</b>
<b>Toma doble RJ45 cat. 5e</b>	Mecanismo con tapa Marco 1 elemento	WL2120	37,06	WL2122	46,78	WL2123	46,78
		WL5510	1,25	WL5512	3,42	WL5513	3,42
			<b>38,31</b>		<b>50,20</b>		<b>50,20</b>
<b>Toma TV</b>	Mecanismo con tapa Marco 1 elemento	WL3010	22,77	WL3012	28,76	WL3013	28,76
		WL5510	1,25	WL5512	3,42	WL5513	3,42
			<b>24,02</b>		<b>32,18</b>		<b>32,18</b>
<b>Tapa ciega</b>	Mecanismo con tapa Marco 1 elemento	WL7010	7,64	WL7012	9,53	WL7013	9,53
		WL5510	1,25	WL5512	3,42	WL5513	3,42
			<b>8,89</b>		<b>12,95</b>		<b>12,95</b>
<b>Regulador rotativo</b>	Mecanismo con tapa Marco 1 elemento	WL4010	61,70	WL4012	77,89	WL4013	77,89
		WL5510	1,25	WL5512	3,42	WL5513	3,42
			<b>62,95</b>		<b>81,31</b>		<b>81,31</b>
<b>Marco vertical</b>	2 elementos	WL5620	2,31	WL5622	6,26	WL5623	6,26
	3 elementos	WL5630	3,58	WL5632	9,71	WL5633	9,71
	4 elementos	WL5640	6,35	WL5642	17,24	WL5643	17,24
	5 elementos	WL5650	8,88	WL5652	24,09	WL5653	24,09
<b>Marco horizontal</b>	2 elementos	WL5720	2,31	WL5722	6,26	WL5723	6,26
	3 elementos	WL5730	3,58	WL5732	9,71	WL5733	9,71
	4 elementos	WL5740	6,35	WL5742	17,24	WL5743	17,24
	5 elementos	WL5750	8,88	WL5752	24,09	WL5753	24,09

		blanco brillo		blanco polar brillo		blanco polar mate		aluminio		antracita	
											
		Ref.	Precio	Ref.	Precio	Ref.	Precio	Ref.	Precio	Ref.	Precio
<b>Interruptor</b>	Mecanismo	3031	4,91	3031	4,91	3031	4,91	3031	4,91	3031	4,91
	Tecla	1620 89 82	1,68	1620 89 89	1,68	1620 19 09	1,80	1620 14 04	7,31	1620 16 06	3,40
	Marco 1 elemento	1011 89 82	1,27	1011 89 89	1,27	1011 99 09	1,41	1011 99 39	2,46	1011 99 49	5,80
			<b>7,86</b>		<b>7,86</b>		<b>8,12</b>		<b>14,68</b>		<b>14,11</b>
<b>Conmutador</b>	Mecanismo	3036	5,61	3036	5,61	3036	5,61	3036	5,61	3036	5,61
	Tecla	1620 89 82	1,68	1620 89 89	1,68	1620 19 09	1,80	1620 14 04	7,31	1620 16 06	3,40
	Marco 1 elemento	1011 89 82	1,27	1011 89 89	1,27	1011 99 09	1,41	1011 99 39	2,46	1011 99 49	5,80
			<b>8,56</b>		<b>8,56</b>		<b>8,82</b>		<b>15,38</b>		<b>14,81</b>
<b>Cruzamiento</b>	Mecanismo	3037	11,63	3037	11,63	3037	11,63	3037	11,63	3037	11,63
	Tecla	1620 89 82	1,68	1620 89 89	1,68	1620 19 09	1,80	1620 14 04	7,31	1620 16 06	3,40
	Marco 1 elemento	1011 89 82	1,27	1011 89 89	1,27	1011 99 09	1,41	1011 99 39	2,46	1011 99 49	5,80
			<b>14,58</b>		<b>14,58</b>		<b>14,84</b>		<b>21,40</b>		<b>20,83</b>
<b>Toma SCHUKO*</b>	Mecanismo	7141 34	5,82	73 4123 89 89	9,72	7141 34	5,82	7141 34	5,82	7141 34	5,82
	Tapa	1719 89 82	4,58			1719 19 09	4,94	1719 14 04	6,65	1719 16 06	5,27
	Marco 1 elemento	1011 89 82	1,27	1011 89 89	1,27	1011 99 09	1,41	1011 99 39	2,46	1011 99 49	5,80
			<b>11,67</b>		<b>10,99</b>		<b>12,17</b>		<b>14,93</b>		<b>16,89</b>
<b>Pulsador</b>	Mecanismo	5031	6,02	5031	6,02	5031	6,02	5031	6,02	5031	6,02
	Tecla	1620 89 82	1,68	1620 89 89	1,68	1620 19 09	1,80	1620 14 04	7,31	1620 16 06	3,40
	Marco 1 elemento	1011 89 82	1,27	1011 89 89	1,27	1011 99 09	1,41	1011 99 39	2,46	1011 99 49	5,80
			<b>8,97</b>		<b>8,97</b>		<b>9,23</b>		<b>15,79</b>		<b>15,22</b>
<b>Doble interruptor</b>	Mecanismo	3035	7,36	3035	7,36	3035	7,36	3035	7,36	3035	7,36
	Tecla	1623 89 82	3,09	1623 89 89	3,09	1623 19 09	3,20	1623 14 04	10,20	1623 16 06	6,66
	Marco 1 elemento	1011 89 82	1,27	1011 89 89	1,27	1011 99 09	1,41	1011 99 39	2,46	1011 99 49	5,80
			<b>11,72</b>		<b>11,72</b>		<b>11,97</b>		<b>20,02</b>		<b>19,82</b>
<b>Doble conmutador</b>	Mecanismo	3038 08	18,30	3038 08	18,30	3038 08	18,30	3038 08	18,30	3038 08	18,30
	Tecla	1623 89 82	3,09	1623 89 89	3,09	1623 19 09	3,20	1623 14 04	10,20	1623 16 06	6,66
	Marco 1 elemento	1011 89 82	1,27	1011 89 89	1,27	1011 99 09	1,41	1011 99 39	2,46	1011 99 49	5,80
			<b>22,66</b>		<b>22,66</b>		<b>22,91</b>		<b>30,96</b>		<b>30,76</b>
<b>Doble interruptor persianas</b>	Mecanismo	3035 20	16,94	3035 20	16,94	3035 20	16,94	3035 20	16,94	3035 20	16,94
	Tecla doble con flecha	1625 89 82	6,66	1625 89 89	6,66	1625 19 09	7,46	1625 14 04	14,86	1625 16 06	11,59
	Marco 1 elemento	1011 89 82	1,27	1011 89 89	1,27	1011 99 09	1,41	1011 99 39	2,46	1011 99 49	5,80
			<b>24,87</b>		<b>24,87</b>		<b>25,81</b>		<b>34,26</b>		<b>34,33</b>
<b>Doble pulsador persianas</b>	Mecanismo	5035 20	16,11	5035 20	16,11	5035 20	16,11	5035 20	16,11	5035 20	16,11
	Tecla doble con flecha	1625 89 82	6,66	1625 89 89	6,66	1625 19 09	7,46	1625 14 04	14,86	1625 16 06	11,59
	Marco 1 elemento	1011 89 82	1,27	1011 89 89	1,27	1011 99 09	1,41	1011 99 39	2,46	1011 99 49	5,80
			<b>24,04</b>		<b>24,04</b>		<b>24,98</b>		<b>33,43</b>		<b>33,50</b>
<b>Toma teléfono cat. 3</b>	Mecanismo	4538	11,61	4538	11,61	4538	11,61	4538	11,61	4538	11,61
	Tapa	1407 89 82	4,84	1407 89 89	4,84	1407 19 09	4,84	1407 14 04	10,32	1407 16 06	7,31
	Marco 1 elemento	1011 89 82	1,27	1011 89 89	1,27	1011 99 09	1,41	1011 99 39	2,46	1011 99 49	5,80
			<b>17,72</b>		<b>17,72</b>		<b>17,86</b>		<b>24,39</b>		<b>24,72</b>
<b>Toma simple RJ45 cat. 6e</b>	Mecanismo	4554 01	28,10	4554 01	28,10	4554 01	28,10	4554 01	28,10	4554 01	28,10
	Tapa	1407 89 82	4,84	1407 89 89	4,84	1407 19 09	4,84	1407 14 04	10,32	1407 16 06	7,31
	Marco 1 elemento	1011 89 82	1,27	1011 89 89	1,27	1011 99 09	1,41	1011 99 39	2,46	1011 99 49	5,80
			<b>34,21</b>		<b>34,21</b>		<b>34,35</b>		<b>40,88</b>		<b>41,21</b>
<b>Toma doble RJ45 cat. 6e</b>	Mecanismo	4555 01	36,15	4555 01	36,15	4555 01	36,15	4555 01	36,15	4555 01	36,15
	Tapa	1409 89 82	5,78	1409 89 89	5,78	1409 19 09	7,10	1409 14 04	12,47	1409 16 06	8,82
	Marco 1 elemento	1011 89 82	1,27	1011 89 89	1,27	1011 99 09	1,41	1011 99 39	2,46	1011 99 49	5,80
			<b>43,20</b>		<b>43,20</b>		<b>44,66</b>		<b>51,08</b>		<b>50,77</b>
<b>Toma TV</b>	Mecanismo	4522 10	20,48	4522 10	20,48	4522 10	20,48	4522 10	20,48	4522 10	20,48
	Tapa	1203 89 82	2,49	1203 89 89	2,49	1203 19 09	2,49	1203 14 04	13,72	1203 16 06	9,70
	Marco 1 elemento	1011 89 82	1,27	1011 89 89	1,27	1011 99 09	1,41	1011 99 39	2,46	1011 99 49	5,80
			<b>24,24</b>		<b>24,24</b>		<b>24,38</b>		<b>36,66</b>		<b>35,98</b>
<b>Salida de hilos</b>	Mecanismo	4470	13,40	4470	13,40	4470	13,40	4470	13,40	4470	13,40
	Tapa	1019 89 82	4,84	1019 89 89	4,84	1019 19 09	5,87	1019 14 04	12,59	1019 16 06	9,00
	Marco 1 elemento	1011 89 82	1,27	1011 89 89	1,27	1011 99 09	1,41	1011 99 39	2,46	1011 99 49	5,80
			<b>19,51</b>		<b>19,51</b>		<b>20,68</b>		<b>28,45</b>		<b>28,20</b>
<b>Tapa ciega</b>	Mecanismo con tapa	1009 89 82	10,40	1009 89 89	10,40	1009 19 09	10,78	1009 14 04	17,88	1009 16 06	13,97
	Marco 1 elemento	1011 89 82	1,27	1011 89 89	1,27	1011 99 09	1,41	1011 99 39	2,46	1011 99 49	5,80
			<b>11,67</b>		<b>11,67</b>		<b>12,19</b>		<b>20,34</b>		<b>19,77</b>
<b>Marco</b>	2 elementos	1012 89 82	2,05	1012 89 89	2,05	1012 99 09	2,18	1012 99 39	3,80	1012 99 49	8,95
	3 elementos	1013 89 82	3,98	1013 89 89	3,98	1013 99 09	4,11	1013 99 39	7,67	1013 99 49	16,85
	4 elementos	1014 89 82	7,32	1014 89 89	7,32	1014 99 09	7,82	1014 99 39	12,39	1014 99 49	32,12
	5 elementos	1015 89 82	10,15	1015 89 89	10,15	1015 99 09	10,92	1015 99 39	13,71	1015 99 49	44,76

		aluminio / blanco polar mate		aluminio / antracita		aluminio / dorado / blanco polar mate		aluminio dorado / antracita	
									
		Ref.	Precio	Ref.	Precio	Ref.	Precio	Ref.	Precio
<b>Interruptor</b>	Mecanismo	3031	4,91	3031	4,91	3031	4,91	3031	4,91
	Tecla	1620 19 09	1,80	1620 16 06	3,40	1620 19 09	1,80	1620 16 06	3,40
	Marco 1 elemento	1011 39 04	14,31	1011 30 04	14,31	1011 30 46	20,54	1011 30 16	20,54
			<b>21,02</b>		<b>22,62</b>		<b>27,25</b>		<b>28,85</b>
<b>Conmutador</b>	Mecanismo	3036	5,61	3036	5,61	3036	5,61	3036	5,61
	Tecla	1620 19 09	1,80	1620 16 06	3,40	1620 19 09	1,80	1620 16 06	3,40
	Marco 1 elemento	1011 39 04	14,31	1011 30 04	14,31	1011 30 46	20,54	1011 30 16	20,54
			<b>21,72</b>		<b>23,32</b>		<b>27,95</b>		<b>29,55</b>
<b>Cruzamiento</b>	Mecanismo	3037	11,63	3037	11,63	3037	11,63	3037	11,63
	Tecla	1620 19 09	1,80	1620 16 06	3,40	1620 19 09	1,80	1620 16 06	3,40
	Marco 1 elemento	1011 39 04	14,31	1011 30 04	14,31	1011 30 46	20,54	1011 30 16	20,54
			<b>27,74</b>		<b>29,34</b>		<b>33,97</b>		<b>35,57</b>
<b>Toma SCHUKO*</b>	Mecanismo	7141 34	5,82	7141 34	5,82	7141 34	5,82	7141 34	5,82
	Tapa	1719 19 09	4,94	1719 16 06	5,27	1719 19 09	4,94	1719 16 06	5,27
	Marco 1 elemento	1011 39 04	14,31	1011 30 04	14,31	1011 30 46	20,54	1011 30 16	20,54
			<b>25,07</b>		<b>25,40</b>		<b>31,30</b>		<b>31,63</b>
<b>Pulsador</b>	Mecanismo	5031	6,02	5031	6,02	5031	6,02	5031	6,02
	Tecla	1620 19 09	1,80	1620 16 06	3,40	1620 19 09	1,80	1620 16 06	3,40
	Marco 1 elemento	1011 39 04	14,31	1011 30 04	14,31	1011 30 46	20,54	1011 30 16	20,54
			<b>22,13</b>		<b>23,73</b>		<b>28,36</b>		<b>29,96</b>
<b>Doble interruptor</b>	Mecanismo	3035	7,36	3035	7,36	3035	7,36	3035	7,36
	Tecla	1623 19 09	3,20	1623 16 06	6,66	1623 19 09	3,20	1623 16 06	6,66
	Marco 1 elemento	1011 39 04	14,31	1011 30 04	14,31	1011 30 46	20,54	1011 30 16	20,54
			<b>24,87</b>		<b>28,33</b>		<b>31,10</b>		<b>34,56</b>
<b>Doble conmutador</b>	Mecanismo	3038 08	18,30	3038 08	18,30	3038 08	18,30	3038 08	18,30
	Tecla	1623 19 09	3,20	1623 16 06	6,66	1623 19 09	3,20	1623 16 06	6,66
	Marco 1 elemento	1011 39 04	14,31	1011 30 04	14,31	1011 30 46	20,54	1011 30 16	20,54
			<b>35,81</b>		<b>39,27</b>		<b>42,04</b>		<b>45,50</b>
<b>Doble interruptor persianas</b>	Mecanismo	3035 20	16,94	3035 20	16,94	3035 20	16,94	3035 20	16,94
	Tecla doble con flecha	1625 19 09	7,46	1625 16 06	11,59	1625 19 09	7,46	1625 16 06	11,59
	Marco 1 elemento	1011 39 04	14,31	1011 30 04	14,31	1011 30 46	20,54	1011 30 16	20,54
			<b>38,71</b>		<b>42,84</b>		<b>44,94</b>		<b>49,07</b>
<b>Doble pulsador persianas</b>	Mecanismo	5035 20	16,11	5035 20	16,11	5035 20	16,11	5035 20	16,11
	Tecla doble con flecha	1625 19 09	7,46	1625 16 06	11,59	1625 19 09	7,46	1625 16 06	11,59
	Marco 1 elemento	1011 39 04	14,31	1011 30 04	14,31	1011 30 46	20,54	1011 30 16	20,54
			<b>37,88</b>		<b>42,01</b>		<b>44,11</b>		<b>48,24</b>
<b>Toma teléfono cat. 3</b>	Mecanismo	4538	11,61	4538	11,61	4538	11,61	4538	11,61
	Tapa	1407 19 09	4,84	1407 16 06	7,31	1407 19 09	4,84	1407 16 06	7,31
	Marco 1 elemento	1011 39 04	14,31	1011 30 04	14,31	1011 30 46	20,54	1011 30 16	20,54
			<b>30,76</b>		<b>33,23</b>		<b>36,99</b>		<b>39,46</b>
<b>Toma simple RJ45 cat. 6e</b>	Mecanismo	4554 01	28,10	4554 01	28,10	4554 01	28,10	4554 01	28,10
	Tapa	1407 19 09	4,84	1407 16 06	7,31	1407 19 09	4,84	1407 16 06	7,31
	Marco 1 elemento	1011 39 04	14,31	1011 30 04	14,31	1011 30 46	20,54	1011 30 16	20,54
			<b>47,25</b>		<b>49,72</b>		<b>53,48</b>		<b>55,95</b>
<b>Toma doble RJ45 cat. 6e</b>	Mecanismo	4555 01	36,15	4555 01	36,15	4555 01	36,15	4555 01	36,15
	Tapa	1409 19 09	7,10	1409 16 06	8,82	1409 19 09	7,10	1409 16 06	8,82
	Marco 1 elemento	1011 39 04	14,31	1011 30 04	14,31	1011 30 46	20,54	1011 30 16	20,54
			<b>57,56</b>		<b>59,28</b>		<b>63,79</b>		<b>65,51</b>
<b>Toma TV</b>	Mecanismo	4522 10	20,48	4522 10	20,48	4522 10	20,48	4522 10	20,48
	Tapa	1203 19 09	2,49	1203 16 06	9,70	1203 19 09	2,49	1203 16 06	9,70
	Marco 1 elemento	1011 39 04	14,31	1011 30 04	14,31	1011 30 46	20,54	1011 30 16	20,54
			<b>37,28</b>		<b>44,49</b>		<b>43,51</b>		<b>50,72</b>
<b>Salida de hilos</b>	Mecanismo	4470	13,40	4470	13,40	4470	13,40	4470	13,40
	Tapa	1019 19 09	5,87	1019 16 06	9,00	1019 19 09	5,87	1019 16 06	9,00
	Marco 1 elemento	1011 39 04	14,31	1011 30 04	14,31	1011 30 46	20,54	1011 30 16	20,54
			<b>33,58</b>		<b>36,71</b>		<b>39,81</b>		<b>42,94</b>
<b>Tapa ciega</b>	Mecanismo con tapa	1009 19 09	10,78	1009 16 06	13,97	1009 19 09	10,78	1009 16 06	13,97
	Marco 1 elemento	1011 39 04	14,31	1011 30 04	14,31	1011 30 46	20,54	1011 30 16	20,54
			<b>25,09</b>		<b>28,28</b>		<b>31,32</b>		<b>34,51</b>
<b>Marco</b>	2 elementos	1012 39 04	23,26	1012 30 04	23,26	1012 30 46	33,39	1012 30 16	33,39
	3 elementos	1013 39 04	32,11	1013 30 04	32,11	1013 30 46	46,10	1013 30 16	46,10
	4 elementos	1014 39 04	48,63	1014 30 04	48,63	1014 30 46	69,85	1014 30 16	69,85
	5 elementos	1015 39 04	60,06	1015 30 04	60,06	1015 30 46	86,29	1015 30 16	86,29







**Nota:**





La gama berker B.3 está disponible también en los siguientes acabados: negro, marrón y rojo. Estos acabados, existen también combinados con embellecedor y tecla antracita.

 aluminio  
negro / blanco  
polar mate



 aluminio  
marrón / blanco  
polar mate

 aluminio  
rojo / blanco  
polar mate

		blanco polar mate		antracita		aluminio		cristal blanco polar mate		cristal antracita		cristal aluminio	
													
		Ref.	Precio	Ref.	Precio	Ref.	Precio	Ref.	Precio	Ref.	Precio	Ref.	Precio
<b>Interrup-tor</b>	Mecanismo	3031	4,91	3031	4,91	3031	4,91	3031	4,91	3031	4,91	3031	4,91
	Tecla	1620 19 09	1,80	1620 16 06	3,40	1620 14 04	7,31	1620 19 09	1,80	1620 16 06	3,40	1620 14 04	7,31
	Marco 1 elem.	1011 69 19	4,81	1011 66 26	7,00	1011 64 24	5,94	1011 69 09	29,93	1011 66 16	29,93	1011 64 14	29,93
			<b>11,52</b>		<b>15,31</b>		<b>18,16</b>		<b>36,64</b>		<b>38,24</b>		<b>42,15</b>
<b>Conmu-tador</b>	Mecanismo	3036	5,61	3036	5,61	3036	5,61	3036	5,61	3036	5,61	3036	5,61
	Tecla	1620 19 09	1,80	1620 16 06	3,40	1620 14 04	7,31	1620 19 09	1,80	1620 16 06	3,40	1620 14 04	7,31
	Marco 1 elem.	1011 69 19	4,81	1011 66 26	7,00	1011 64 24	5,94	1011 69 09	29,93	1011 66 16	29,93	1011 64 14	29,93
			<b>12,22</b>		<b>16,01</b>		<b>18,86</b>		<b>37,34</b>		<b>38,94</b>		<b>42,85</b>
<b>Cruza-miento</b>	Mecanismo	3037	11,63	3037	11,63	3037	11,63	3037	11,63	3037	11,63	3037	11,63
	Tecla	1620 19 09	1,80	1620 16 06	3,40	1620 14 04	7,31	1620 19 09	1,80	1620 16 06	3,40	1620 14 04	7,31
	Marco 1 elem.	1011 69 19	4,81	1011 66 26	7,00	1011 64 24	5,94	1011 69 09	29,93	1011 66 16	29,93	1011 64 14	29,93
			<b>18,24</b>		<b>22,03</b>		<b>24,88</b>		<b>43,36</b>		<b>44,96</b>		<b>48,87</b>
<b>Toma SCHUKO*</b>	Mecanismo	7141 34	5,82	7141 34	5,82	7141 34	5,82	7141 34	5,82	7141 34	5,82	7141 34	5,82
	Tapa	1719 19 09	4,94	1719 16 06	5,27	1719 14 04	6,65	1719 19 09	4,94	1719 16 06	5,27	1719 14 04	6,65
	Marco 1 elem.	1011 69 19	4,81	1011 66 26	7,00	1011 64 24	5,94	1011 69 09	29,93	1011 66 16	29,93	1011 64 14	29,93
			<b>15,57</b>		<b>18,09</b>		<b>18,41</b>		<b>40,69</b>		<b>41,02</b>		<b>42,40</b>
<b>Pulsador</b>	Mecanismo	5031	6,02	5031	6,02	5031	6,02	5031	6,02	5031	6,02	5031	6,02
	Tecla	1620 19 09	1,80	1620 16 06	3,40	1620 14 04	7,31	1620 19 09	1,80	1620 16 06	3,40	1620 14 04	7,31
	Marco 1 elem.	1011 69 19	4,81	1011 66 26	7,00	1011 64 24	5,94	1011 69 09	29,93	1011 66 16	29,93	1011 64 14	29,93
			<b>12,63</b>		<b>16,42</b>		<b>19,27</b>		<b>37,75</b>		<b>39,35</b>		<b>43,26</b>
<b>Doble interrup-tor</b>	Mecanismo	3035	7,36	3035	7,36	3035	7,36	3035	7,36	3035	7,36	3035	7,36
	Tecla	1623 19 09	3,20	1623 16 06	6,66	1623 14 04	10,20	1623 19 09	3,20	1623 16 06	6,66	1623 14 04	10,20
	Marco 1 elem.	1011 69 19	4,81	1011 66 26	7,00	1011 64 24	5,94	1011 69 09	29,93	1011 66 16	29,93	1011 64 14	29,93
			<b>15,37</b>		<b>21,02</b>		<b>23,50</b>		<b>40,49</b>		<b>43,95</b>		<b>47,49</b>
<b>Doble conmu-tador</b>	Mecanismo	3038 08	18,30	3038 08	18,30	3038 08	18,30	3038 08	18,30	3038 08	18,30	3038 08	18,30
	Tecla	1623 19 09	3,20	1623 16 06	6,66	1623 14 04	10,20	1623 19 09	3,20	1623 16 06	6,66	1623 14 04	10,20
	Marco 1 elem.	1011 69 19	4,81	1011 66 26	7,00	1011 64 24	5,94	1011 69 09	29,93	1011 66 16	29,93	1011 64 14	29,93
			<b>26,31</b>		<b>31,96</b>		<b>34,44</b>		<b>51,43</b>		<b>54,89</b>		<b>58,43</b>
<b>Doble interrup-tor persianas</b>	Mecanismo	3035 20	16,94	3035 20	16,94	3035 20	16,94	3035 20	16,94	3035 20	16,94	3035 20	16,94
	Tecla doble c/flecha	1625 19 09	7,46	1625 16 06	11,59	1625 14 04	14,86	1625 19 09	7,46	1625 16 06	11,59	1625 14 04	14,86
	Marco 1 elem.	1011 69 19	4,81	1011 66 26	7,00	1011 64 24	5,94	1011 69 09	29,93	1011 66 16	29,93	1011 64 14	29,93
			<b>29,21</b>		<b>35,53</b>		<b>37,74</b>		<b>54,33</b>		<b>58,46</b>		<b>61,73</b>
<b>Doble pulsador persianas</b>	Mecanismo	5035 20	16,11	5035 20	16,11	5035 20	16,11	5035 20	16,11	5035 20	16,11	5035 20	16,11
	Tecla doble c/flecha	1625 19 09	7,46	1625 16 06	11,59	1625 14 04	14,86	1625 19 09	7,46	1625 16 06	11,59	1625 14 04	14,86
	Marco 1 elem.	1011 69 19	4,81	1011 66 26	7,00	1011 64 24	5,94	1011 69 09	29,93	1011 66 16	29,93	1011 64 14	29,93
			<b>28,38</b>		<b>34,70</b>		<b>36,91</b>		<b>53,50</b>		<b>57,63</b>		<b>60,90</b>
<b>Toma teléfono cat. 3</b>	Mecanismo	4538	11,61	4538	11,61	4538	11,61	4538	11,61	4538	11,61	4538	11,61
	Tapa	1407 19 09	4,84	1407 16 06	7,31	1407 14 04	10,32	1407 19 09	4,84	1407 16 06	7,31	1407 14 04	10,32
	Marco 1 elem.	1011 69 19	4,81	1011 66 26	7,00	1011 64 24	5,94	1011 69 09	29,93	1011 66 16	29,93	1011 64 14	29,93
			<b>21,26</b>		<b>25,92</b>		<b>27,87</b>		<b>46,38</b>		<b>48,85</b>		<b>51,86</b>
<b>Toma simple RJ45 cat. 6e</b>	Mecanismo	4554 01	28,10	4554 01	28,10	4554 01	28,10	4554 01	28,10	4554 01	28,10	4554 01	28,10
	Tapa	1407 19 09	4,84	1407 16 06	7,31	1407 14 04	10,32	1407 19 09	4,84	1407 16 06	7,31	1407 14 04	10,32
	Marco 1 elem.	1011 69 19	4,81	1011 66 26	7,00	1011 64 24	5,94	1011 69 09	29,93	1011 66 16	29,93	1011 64 14	29,93
			<b>37,75</b>		<b>42,41</b>		<b>44,36</b>		<b>62,87</b>		<b>65,34</b>		<b>68,35</b>
<b>Toma doble RJ45 cat. 6e</b>	Mecanismo	4555 01	36,15	4555 01	36,15	4555 01	36,15	4555 01	36,15	4555 01	36,15	4555 01	36,15
	Tapa	1409 19 09	7,10	1409 16 06	8,82	1409 14 04	12,47	1409 19 09	7,10	1409 16 06	8,82	1409 14 04	12,47
	Marco 1 elem.	1011 69 19	4,81	1011 66 26	7,00	1011 64 24	5,94	1011 69 09	29,93	1011 66 16	29,93	1011 64 14	29,93
			<b>48,06</b>		<b>51,97</b>		<b>54,56</b>		<b>73,18</b>		<b>74,90</b>		<b>78,55</b>
<b>Toma TV</b>	Mecanismo	4522 10	20,48	4522 10	20,48	4522 10	20,48	4522 10	20,48	4522 10	20,48	4522 10	20,48
	Tapa	1203 19 09	2,49	1203 16 06	9,70	1203 14 04	13,72	1203 19 09	2,49	1203 16 06	9,70	1203 14 04	13,72
	Marco 1 elem.	1011 69 19	4,81	1011 66 26	7,00	1011 64 24	5,94	1011 69 09	29,93	1011 66 16	29,93	1011 64 14	29,93
			<b>27,78</b>		<b>37,18</b>		<b>40,14</b>		<b>52,90</b>		<b>60,11</b>		<b>64,13</b>
<b>Salida de hilos</b>	Mecanismo	4470	13,40	4470	13,40	4470	13,40	4470	13,40	4470	13,40	4470	13,40
	Tapa	1019 19 09	5,87	1019 16 06	9,00	1019 14 04	12,59	1019 19 09	5,87	1019 16 06	9,00	1019 14 04	12,59
	Marco 1 elem.	1011 69 19	4,81	1011 66 26	7,00	1011 64 24	5,94	1011 69 09	29,93	1011 66 16	29,93	1011 64 14	29,93
			<b>24,08</b>		<b>29,40</b>		<b>31,93</b>		<b>49,20</b>		<b>52,33</b>		<b>55,92</b>
<b>Tapa ciega</b>	Mec. con tapa	1009 19 09	10,78	1009 16 06	13,97	1009 14 04	17,88	1009 19 09	10,78	1009 16 06	13,97	1009 14 04	17,88
	Marco 1 elem.	1011 69 19	4,81	1011 66 26	7,00	1011 64 24	5,94	1011 69 09	29,93	1011 66 16	29,93	1011 64 14	29,93
			<b>15,59</b>		<b>20,97</b>		<b>23,82</b>		<b>40,71</b>		<b>43,90</b>		<b>47,81</b>
<b>Marco</b>	2 elementos	1012 69 19	7,02	1012 66 26	10,69	1012 64 24	9,32	1012 69 09	55,85	1012 66 16	55,85	1012 64 14	55,85
	3 elementos	1013 69 19	12,08	1013 66 26	17,56	1013 64 24	49,07	1013 69 09	90,64	1013 66 16	90,64	1013 64 14	90,64
	4 elementos	1014 69 19	42,81	1014 66 26	50,37	1014 64 24	54,86	1014 69 09	123,29	1014 66 16	123,29	1014 64 14	123,29
	5 elementos	1015 69 19	67,98	1015 66 26	70,50	1015 64 24	86,04	1015 69 09	162,71	1015 66 16	162,71	1015 64 14	162,71

		aluminio <sup>(1)</sup> / blanco polar mate		aluminio / antracita		acero <sup>(1)</sup> / blanco polar mate		acero / antracita	
									
		Ref.	Precio	Ref.	Precio	Ref.	Precio	Ref.	Precio
<b>Interruptor</b>	Mecanismo	3031	4,91	3031	4,91	3031	4,91	3031	4,91
	Tecla	1620 19 09	1,80	1620 16 06	3,40	1620 19 09	1,80	1620 16 06	3,40
	Marco 1 elemento	1011 69 14	50,37	1011 69 04	50,37	1011 36 09	56,66	1011 36 06	56,66
			<b>57,08</b>		<b>58,68</b>		<b>63,37</b>		<b>64,97</b>
<b>Conmutador</b>	Mecanismo	3036	5,61	3036	5,61	3036	5,61	3036	5,61
	Tecla	1620 19 09	1,80	1620 16 06	3,40	1620 19 09	1,80	1620 16 06	3,40
	Marco 1 elemento	1011 69 14	50,37	1011 69 04	50,37	1011 36 09	56,66	1011 36 06	56,66
			<b>57,78</b>		<b>59,38</b>		<b>64,07</b>		<b>65,67</b>
<b>Cruzamiento</b>	Mecanismo	3037	11,63	3037	11,63	3037	11,63	3037	11,63
	Tecla	1620 19 09	1,80	1620 16 06	3,40	1620 19 09	1,80	1620 16 06	3,40
	Marco 1 elemento	1011 69 14	50,37	1011 69 04	50,37	1011 36 09	56,66	1011 36 06	56,66
			<b>63,80</b>		<b>65,40</b>		<b>70,09</b>		<b>71,69</b>
<b>Toma SCHUKO*</b>	Mecanismo	7141 34	5,82	7141 34	5,82	7141 34	5,82	7141 34	5,82
	Tapa	1719 19 09	4,94	1719 16 06	5,27	1719 19 09	4,94	1719 16 06	5,27
	Marco 1 elemento	1011 69 14	50,37	1011 69 04	50,37	1011 36 09	56,66	1011 36 06	56,66
			<b>61,13</b>		<b>61,46</b>		<b>67,42</b>		<b>67,75</b>
<b>Pulsador</b>	Mecanismo	5031	6,02	5031	6,02	5031	6,02	5031	6,02
	Tecla	1620 19 09	1,80	1620 16 06	3,40	1620 19 09	1,80	1620 16 06	3,40
	Marco 1 elemento	1011 69 14	50,37	1011 69 04	50,37	1011 36 09	56,66	1011 36 06	56,66
			<b>58,19</b>		<b>59,79</b>		<b>64,48</b>		<b>66,08</b>
<b>Doble interruptor</b>	Mecanismo	3035	7,36	3035	7,36	3035	7,36	3035	7,36
	Tecla	1623 19 09	3,20	1623 16 06	6,66	1623 19 09	3,20	1623 16 06	6,66
	Marco 1 elemento	1011 69 14	50,37	1011 69 04	50,37	1011 36 09	56,66	1011 36 06	56,66
			<b>60,93</b>		<b>64,39</b>		<b>67,22</b>		<b>70,68</b>
<b>Doble conmutador</b>	Mecanismo	3038 08	18,30	3038 08	18,30	3038 08	18,30	3038 08	18,30
	Tecla	1623 19 09	3,20	1623 16 06	6,66	1623 19 09	3,20	1623 16 06	6,66
	Marco 1 elemento	1011 69 14	50,37	1011 69 04	50,37	1011 36 09	56,66	1011 36 06	56,66
			<b>71,87</b>		<b>75,33</b>		<b>78,16</b>		<b>81,62</b>
<b>Doble interruptor persianas</b>	Mecanismo	3035 20	16,94	3035 20	16,94	3035 20	16,94	3035 20	16,94
	Tecla doble con flecha	1625 19 09	7,46	1625 16 06	11,59	1625 19 09	7,46	1625 16 06	11,59
	Marco 1 elemento	1011 69 14	50,37	1011 69 04	50,37	1011 36 09	56,66	1011 36 06	56,66
			<b>74,77</b>		<b>78,90</b>		<b>81,06</b>		<b>85,19</b>
<b>Doble pulsador persianas</b>	Mecanismo	5035 20	16,11	5035 20	16,11	5035 20	16,11	5035 20	16,11
	Tecla doble con flecha	1625 19 09	7,46	1625 16 06	11,59	1625 19 09	7,46	1625 16 06	11,59
	Marco 1 elemento	1011 69 14	50,37	1011 69 04	50,37	1011 36 09	56,66	1011 36 06	56,66
			<b>73,94</b>		<b>78,07</b>		<b>80,23</b>		<b>84,36</b>
<b>Toma teléfono cat. 3</b>	Mecanismo	4538	11,61	4538	11,61	4538	11,61	4538	11,61
	Tapa	1407 19 09	4,84	1407 16 06	7,31	1407 19 09	4,84	1407 16 06	7,31
	Marco 1 elemento	1011 69 14	50,37	1011 69 04	50,37	1011 36 09	56,66	1011 36 06	56,66
			<b>66,82</b>		<b>69,29</b>		<b>73,11</b>		<b>75,58</b>
<b>Toma simple RJ45 cat. 6e</b>	Mecanismo	4554 01	28,10	4554 01	28,10	4554 01	28,10	4554 01	28,10
	Tapa	1407 19 09	4,84	1407 16 06	7,31	1407 19 09	4,84	1407 16 06	7,31
	Marco 1 elemento	1011 69 14	50,37	1011 69 04	50,37	1011 36 09	56,66	1011 36 06	56,66
			<b>83,31</b>		<b>85,78</b>		<b>89,60</b>		<b>92,07</b>
<b>Toma doble RJ45 cat. 6e</b>	Mecanismo	4555 01	36,15	4555 01	36,15	4555 01	36,15	4555 01	36,15
	Tapa	1409 19 09	7,10	1409 16 06	8,82	1409 19 09	7,10	1409 16 06	8,82
	Marco 1 elemento	1011 69 14	50,37	1011 69 04	50,37	1011 36 09	56,66	1011 36 06	56,66
			<b>93,62</b>		<b>95,34</b>		<b>99,91</b>		<b>101,63</b>
<b>Toma TV</b>	Mecanismo	4522 10	20,48	4522 10	20,48	4522 10	20,48	4522 10	20,48
	Tapa	1203 19 09	2,49	1203 16 06	9,70	1203 19 09	2,49	1203 16 06	9,70
	Marco 1 elemento	1011 69 14	50,37	1011 69 04	50,37	1011 36 09	56,66	1011 36 06	56,66
			<b>73,34</b>		<b>80,55</b>		<b>79,63</b>		<b>86,84</b>
<b>Salida de hilos</b>	Mecanismo	4470	13,40	4470	13,40	4470	13,40	4470	13,40
	Tapa	1019 19 09	5,87	1019 16 06	9,00	1019 19 09	5,87	1019 16 06	9,00
	Marco 1 elemento	1011 69 14	50,37	1011 69 04	50,37	1011 36 09	56,66	1011 36 06	56,66
			<b>69,64</b>		<b>72,77</b>		<b>75,93</b>		<b>79,06</b>
<b>Tapa ciega</b>	Mecanismo con tapa	1009 19 09	10,78	1009 16 06	13,97	1009 19 09	10,78	1009 16 06	13,97
	Marco 1 elemento	1011 69 14	50,37	1011 69 04	50,37	1011 36 09	56,66	1011 36 06	56,66
			<b>61,15</b>		<b>64,34</b>		<b>67,44</b>		<b>70,63</b>
<b>Marco</b>	2 elementos	1012 69 14	88,91	1012 69 04	88,91	1022 36 09	100,02	1022 36 06	100,02
	3 elementos	1013 69 14	101,84	1013 69 04	98,73	1023 36 09	167,24	1023 36 06	167,24
	4 elementos	1014 69 14	139,27	1014 69 04	135,02	1024 36 09	228,76	1024 36 06	228,76
	5 elementos	1015 69 14	189,83	1015 69 04	184,02	1025 36 09	239,19	1025 36 06	239,19

<sup>(1)</sup> Los acabados aluminio y acero blanco polar existen también combinados con embellecedor y tecla antracita.

		blanco polar		antracita		aluminio	
							
		Ref.	Precio	Ref.	Precio	Ref.	Precio
<b>Interruptor</b>	Mecanismo	3031	4,91	3031	4,91	3031	4,91
	Tecla	1620 60 89	2,81	1620 60 86	4,91	1620 60 84	4,91
	Marco 1 elemento	1011 60 89	2,04	1011 60 86	5,92	1011 60 84	5,92
			<b>9,76</b>		<b>15,74</b>		<b>15,74</b>
<b>Conmutador</b>	Mecanismo	3036	5,61	3036	5,61	3036	5,61
	Tecla	1620 60 89	2,81	1620 60 86	4,91	1620 60 84	4,91
	Marco 1 elemento	1011 60 89	2,04	1011 60 86	5,92	1011 60 84	5,92
			<b>10,46</b>		<b>16,44</b>		<b>16,44</b>
<b>Cruzamiento</b>	Mecanismo	3037	11,63	3037	11,63	3037	11,63
	Tecla	1620 60 89	2,81	1620 60 86	4,91	1620 60 84	4,91
	Marco 1 elemento	1011 60 89	2,04	1011 60 86	5,92	1011 60 84	5,92
			<b>16,48</b>		<b>22,46</b>		<b>22,46</b>
<b>Toma SCHUKO*</b>	Mecanismo	73 4123 60 89	10,06	7141 34	5,82	7141 34	5,82
	Tapa			1719 60 86	6,97	1719 60 84	6,97
	Marco 1 elemento	1011 60 89	2,04	1011 60 86	5,92	1011 60 84	5,92
			<b>12,10</b>		<b>18,71</b>		<b>18,71</b>
<b>Pulsador</b>	Mecanismo	5031	6,02	5031	6,02	5031	6,02
	Tecla	1620 60 89	2,81	1620 60 86	4,91	1620 60 84	4,91
	Marco 1 elemento	1011 60 89	2,04	1011 60 86	5,92	1011 60 84	5,92
			<b>10,87</b>		<b>16,85</b>		<b>16,85</b>
<b>Doble interruptor</b>	Mecanismo	3035	7,36	3035	7,36	3035	7,36
	Tecla	1623 60 89	7,41	1623 60 86	8,51	1623 60 84	8,51
	Marco 1 elemento	1011 60 89	2,04	1011 60 86	5,92	1011 60 84	5,92
			<b>16,81</b>		<b>21,79</b>		<b>21,79</b>
<b>Doble conmutador</b>	Mecanismo	3038 08	18,30	3038 08	18,30	3038 08	18,30
	Tecla	1623 60 89	7,41	1623 60 86	8,51	1623 60 84	8,51
	Marco 1 elemento	1011 60 89	2,04	1011 60 86	5,92	1011 60 84	5,92
			<b>27,75</b>		<b>32,73</b>		<b>32,73</b>
<b>Doble interruptor persianas</b>	Mecanismo	3035 20	16,94	3035 20	16,94	3035 20	16,94
	Tecla doble con flecha	1625 60 89	8,31	1625 60 86	11,46	1625 60 84	11,46
	Marco 1 elemento	1011 60 89	2,04	1011 60 86	5,92	1011 60 84	5,92
			<b>27,29</b>		<b>34,32</b>		<b>34,32</b>
<b>Doble pulsador persianas</b>	Mecanismo	5035 20	16,11	5035 20	16,11	5035 20	16,11
	Tecla doble con flecha	1625 60 89	8,31	1625 60 86	11,46	1625 60 84	11,46
	Marco 1 elemento	1011 60 89	2,04	1011 60 86	5,92	1011 60 84	5,92
			<b>26,46</b>		<b>33,49</b>		<b>33,49</b>
<b>Toma teléfono cat. 3</b>	Mecanismo	4538	11,61	4538	11,61	4538	11,61
	Tapa	1407 60 89	6,39	1407 60 86	9,61	1407 60 84	9,61
	Marco 1 elemento	1011 60 89	2,04	1011 60 86	5,92	1011 60 84	5,92
			<b>20,04</b>		<b>27,14</b>		<b>27,14</b>
<b>Toma simple RJ45 cat. 6e</b>	Mecanismo	4554 01	28,10	4554 01	28,10	4554 01	28,10
	Tapa	1407 60 89	6,39	1407 60 86	9,61	1407 60 84	9,61
	Marco 1 elemento	1011 60 89	2,04	1011 60 86	5,92	1011 60 84	5,92
			<b>36,53</b>		<b>43,63</b>		<b>43,63</b>
<b>Toma doble RJ45 cat. 6ae</b>	Mecanismo	4555 01	36,15	4555 01	36,15	4555 01	36,15
	Tapa	1409 60 89	6,39	1409 60 86	9,61	1409 60 84	9,61
	Marco 1 elemento	1011 60 89	2,04	1011 60 86	5,92	1011 60 84	5,92
			<b>44,58</b>		<b>51,68</b>		<b>51,68</b>
<b>Toma TV</b>	Mecanismo	4522 10	20,48	4522 10	20,48	4522 10	20,48
	Tapa	1203 60 89	5,89	1203 60 86	9,61	1203 60 84	9,61
	Marco 1 elemento	1011 60 89	2,04	1011 60 86	5,92	1011 60 84	5,92
			<b>28,41</b>		<b>36,01</b>		<b>36,01</b>
<b>Salida de hilos</b>	Mecanismo	4470	13,40	4470	13,40	4470	13,40
	Tapa	1019 60 89	8,07	1019 60 86	9,80	1019 60 84	9,80
	Marco 1 elemento	1011 60 89	2,04	1011 60 86	5,92	1011 60 84	5,92
			<b>23,51</b>		<b>29,12</b>		<b>29,12</b>
<b>Tapa ciega</b>	Mecanismo con tapa	1009 60 89	12,40	1009 60 86	24,23	1009 60 84	24,23
	Marco 1 elemento	1011 60 89	2,04	1011 60 86	5,92	1011 60 84	5,92
				<b>14,44</b>		<b>30,15</b>	
<b>Marco</b>	2 elementos	1012 60 89	3,82	1012 60 86	8,57	1012 60 84	8,57
	3 elementos	1013 60 89	6,15	1013 60 86	14,84	1013 60 84	14,84
	4 elementos	1014 60 89	8,55	1014 60 86	23,59	1014 60 84	23,59
	5 elementos	1015 60 89	13,82	1015 60 86	36,48	1015 60 84	36,48

blanco  
polar



antracita



aluminio



		Ref.	Precio	Ref.	Precio	Ref.	Precio
<b>Interruptor</b>	Mecanismo	3031	4,91	3031	4,91	3031	4,91
	Tecla	1620 60 89	2,81	1620 60 86	4,91	1620 60 84	4,91
	Marco 1 elemento	1011 60 99	3,08	1011 60 96	5,92	1011 60 94	5,92
			<b>10,80</b>		<b>15,74</b>		<b>15,74</b>
<b>Conmutador</b>	Mecanismo	3036	5,61	3036	5,61	3036	5,61
	Tecla	1620 60 89	2,81	1620 60 86	4,91	1620 60 84	4,91
	Marco 1 elemento	1011 60 99	3,08	1011 60 96	5,92	1011 60 94	5,92
			<b>11,50</b>		<b>16,44</b>		<b>16,44</b>
<b>Cruzamiento</b>	Mecanismo	3037	11,63	3037	11,63	3037	11,63
	Tecla	1620 60 89	2,81	1620 60 86	4,91	1620 60 84	4,91
	Marco 1 elemento	1011 60 99	3,08	1011 60 96	5,92	1011 60 94	5,92
			<b>17,52</b>		<b>22,46</b>		<b>22,46</b>
<b>Toma SCHUKO*</b>	Mecanismo	73 4123 60 89	10,06	7141 34	5,82	7141 34	5,82
	Tapa			1719 60 86	6,97	1719 60 84	6,97
	Marco 1 elemento	1011 60 99	3,08	1011 60 96	5,92	1011 60 94	5,92
			<b>13,14</b>		<b>18,71</b>		<b>18,71</b>
<b>Pulsador</b>	Mecanismo	5031	6,02	5031	6,02	5031	6,02
	Tecla	1620 60 89	2,81	1620 60 86	4,91	1620 60 84	4,91
	Marco 1 elemento	1011 60 99	3,08	1011 60 96	5,92	1011 60 94	5,92
			<b>11,91</b>		<b>16,85</b>		<b>16,85</b>
<b>Doble interruptor</b>	Mecanismo	3035	7,36	3035	7,36	3035	7,36
	Tecla	1623 60 89	7,41	1623 60 86	8,51	1623 60 84	8,51
	Marco 1 elemento	1011 60 99	3,08	1011 60 96	5,92	1011 60 94	5,92
			<b>17,85</b>		<b>21,79</b>		<b>21,79</b>
<b>Doble conmutador</b>	Mecanismo	3038 08	18,30	3038 08	18,30	3038 08	18,30
	Tecla	1623 60 89	7,41	1623 60 86	8,51	1623 60 84	8,51
	Marco 1 elemento	1011 60 99	3,08	1011 60 96	5,92	1011 60 94	5,92
			<b>28,79</b>		<b>32,73</b>		<b>32,73</b>
<b>Doble interruptor persianas</b>	Mecanismo	3035 20	16,94	3035 20	16,94	3035 20	16,94
	Tecla doble con flecha	1625 60 89	8,31	1625 60 86	11,46	1625 60 84	11,46
	Marco 1 elemento	1011 60 99	3,08	1011 60 96	5,92	1011 60 94	5,92
			<b>28,33</b>		<b>34,32</b>		<b>34,32</b>
<b>Doble pulsador persianas</b>	Mecanismo	5035 20	16,11	5035 20	16,11	5035 20	16,11
	Tecla doble con flecha	1625 60 89	8,31	1625 60 86	11,46	1625 60 84	11,46
	Marco 1 elemento	1011 60 99	3,08	1011 60 96	5,92	1011 60 94	5,92
			<b>27,50</b>		<b>33,49</b>		<b>33,49</b>
<b>Toma teléfono cat. 3</b>	Mecanismo	4538	11,61	4538	11,61	4538	11,61
	Tapa	1407 60 89	6,39	1407 60 86	9,61	1407 60 84	9,61
	Marco 1 elemento	1011 60 99	3,08	1011 60 96	5,92	1011 60 94	5,92
			<b>21,08</b>		<b>27,14</b>		<b>27,14</b>
<b>Toma simple RJ45 cat. 6e</b>	Mecanismo	4554 01	28,10	4554 01	28,10	4554 01	28,10
	Tapa	1407 60 89	6,39	1407 60 86	9,61	1407 60 84	9,61
	Marco 1 elemento	1011 60 99	3,08	1011 60 96	5,92	1011 60 94	5,92
			<b>37,57</b>		<b>43,63</b>		<b>43,63</b>
<b>Toma doble RJ45 cat. 6e</b>	Mecanismo	4555 01	36,15	4555 01	36,15	4555 01	36,15
	Tapa	1409 60 89	6,39	1409 60 86	9,61	1409 60 84	9,61
	Marco 1 elemento	1011 60 99	3,08	1011 60 96	5,92	1011 60 94	5,92
			<b>45,62</b>		<b>51,68</b>		<b>51,68</b>
<b>Toma TV</b>	Mecanismo	4522 10	20,48	4522 10	20,48	4522 10	20,48
	Tapa	1203 60 89	5,89	1203 60 86	9,61	1203 60 84	9,61
	Marco 1 elemento	1011 60 99	3,08	1011 60 96	5,92	1011 60 94	5,92
			<b>29,45</b>		<b>36,01</b>		<b>36,01</b>
<b>Salida de hilos</b>	Mecanismo	4470	13,40	4470	13,40	4470	13,40
	Tapa	1019 60 89	8,07	1019 60 86	9,80	1019 60 84	9,80
	Marco 1 elemento	1011 60 99	3,08	1011 60 96	5,92	1011 60 94	5,92
			<b>24,55</b>		<b>29,12</b>		<b>29,12</b>
<b>Tapa ciega</b>	Mecanismo con tapa	1009 60 89	12,40	1009 60 86	24,23	1009 60 84	24,23
	Marco 1 elemento	1011 60 99	3,08	1011 60 96	5,92	1011 60 94	5,92
			<b>15,48</b>		<b>30,15</b>		<b>30,15</b>
<b>Marco</b>	2 elementos	1012 60 99	3,82	1012 60 96	8,57	1012 60 94	8,57
	3 elementos	1013 60 99	6,15	1013 60 96	14,84	1013 60 94	14,84
	4 elementos	1014 60 99	8,55	1014 60 96	23,59	1014 60 94	23,59
	5 elementos	1015 60 99	13,82	1015 60 96	36,48	1015 60 94	36,48

blanco polar









aluminio



antracita



		Ref.	Precio	Ref.	Precio	Ref.	Precio
<b>Interruptor</b>	Mecanismo	3031	4,91	3031	4,91	3031	4,91
	Tecla	1620 60 89	2,81	1620 60 84	4,91	1620 60 86	4,91
	Marco 1 elemento	1011 61 89	6,32	1011 61 84	8,42	1011 61 86	8,42
			<b>14,04</b>		<b>18,24</b>		<b>18,24</b>
<b>Conmutador</b>	Mecanismo	3036	5,61	3036	5,61	3036	5,61
	Tecla	1620 60 89	2,81	1620 60 84	4,91	1620 60 86	4,91
	Marco 1 elemento	1011 61 89	6,32	1011 61 84	8,42	1011 61 86	8,42
			<b>14,74</b>		<b>18,94</b>		<b>18,94</b>
<b>Cruzamiento</b>	Mecanismo	3037	11,63	3037	11,63	3037	11,63
	Tecla	1620 60 89	2,81	1620 60 84	4,91	1620 60 86	4,91
	Marco 1 elemento	1011 61 89	6,32	1011 61 84	8,42	1011 61 86	8,42
			<b>20,76</b>		<b>24,96</b>		<b>24,96</b>
<b>Toma SCHUKO*</b>	Mecanismo	73 4123 60 89	10,06	7141 34	5,82	7141 34	5,82
	Tapa			1719 60 84	6,97	1719 60 86	6,97
	Marco 1 elemento	1011 61 89	6,32	1011 61 84	8,42	1011 61 86	8,42
			<b>16,38</b>		<b>21,21</b>		<b>21,21</b>
<b>Pulsador</b>	Mecanismo	5031	6,02	5031	6,02	5031	6,02
	Tecla	1620 60 89	2,81	1620 60 84	4,91	1620 60 86	4,91
	Marco 1 elemento	1011 61 89	6,32	1011 61 84	8,42	1011 61 86	8,42
			<b>15,15</b>		<b>19,35</b>		<b>19,35</b>
<b>Doble interruptor</b>	Mecanismo	3035	7,36	3035	7,36	3035	7,36
	Tecla	1623 60 89	7,41	1623 60 84	8,51	1623 60 86	8,51
	Marco 1 elemento	1011 61 89	6,32	1011 61 84	8,42	1011 61 86	8,42
			<b>21,09</b>		<b>24,29</b>		<b>24,29</b>
<b>Doble conmutador</b>	Mecanismo	3038 08	18,30	3038 08	18,30	3038 08	18,30
	Tecla	1623 60 89	7,41	1623 60 84	8,51	1623 60 86	8,51
	Marco 1 elemento	1011 61 89	6,32	1011 61 84	8,42	1011 61 86	8,42
			<b>32,03</b>		<b>35,23</b>		<b>35,23</b>
<b>Doble interruptor persianas</b>	Mecanismo	3035 20	16,94	3035 20	16,94	3035 20	16,94
	Tecla doble con flecha	1625 60 89	8,31	1625 60 84	11,46	1625 60 86	11,46
	Marco 1 elemento	1011 61 89	6,32	1011 61 84	8,42	1011 61 86	8,42
			<b>31,57</b>		<b>36,82</b>		<b>36,82</b>
<b>Doble pulsador persianas</b>	Mecanismo	5035 20	16,11	5035 20	16,11	5035 20	16,11
	Tecla doble con flecha	1625 60 89	8,31	1625 60 84	11,46	1625 60 86	11,46
	Marco 1 elemento	1011 61 89	6,32	1011 61 84	8,42	1011 61 86	8,42
			<b>30,74</b>		<b>35,99</b>		<b>35,99</b>
<b>Toma teléfono cat. 3</b>	Mecanismo	4538	11,61	4538	11,61	4538	11,61
	Tapa	1407 60 89	6,39	1407 60 84	9,61	1407 60 86	9,61
	Marco 1 elemento	1011 61 89	6,32	1011 61 84	8,42	1011 61 86	8,42
			<b>24,32</b>		<b>29,64</b>		<b>29,64</b>
<b>Toma simple RJ45 cat. 6e</b>	Mecanismo	4554 01	28,10	4554 01	28,10	4554 01	28,10
	Tapa	1407 60 89	6,39	1407 60 84	9,61	1407 60 86	9,61
	Marco 1 elemento	1011 61 89	6,32	1011 61 84	8,42	1011 61 86	8,42
			<b>40,81</b>		<b>46,13</b>		<b>46,13</b>
<b>Toma doble RJ45 cat. 6e</b>	Mecanismo	4555 01	36,15	4555 01	36,15	4555 01	36,15
	Tapa	1409 60 89	6,39	1409 60 84	9,61	1409 60 86	9,61
	Marco 1 elemento	1011 61 89	6,32	1011 61 84	8,42	1011 61 86	8,42
			<b>48,86</b>		<b>54,18</b>		<b>54,18</b>
<b>Toma TV</b>	Mecanismo	4522 10	20,48	4522 10	20,48	4522 10	20,48
	Tapa	1203 60 89	5,89	1203 60 84	9,61	1203 60 86	9,61
	Marco 1 elemento	1011 61 89	6,32	1011 61 84	8,42	1011 61 86	8,42
			<b>32,69</b>		<b>38,51</b>		<b>38,51</b>
<b>Salida de hilos</b>	Mecanismo	4470	13,40	4470	13,40	4470	13,40
	Tapa	1019 60 89	8,07	1019 60 84	9,80	1019 60 86	9,80
	Marco 1 elemento	1011 61 89	6,32	1011 61 84	8,42	1011 61 86	8,42
			<b>27,79</b>		<b>31,62</b>		<b>31,62</b>
<b>Tapa ciega</b>	Mecanismo con tapa	1009 60 89	12,40	1009 60 84	24,23	1009 60 86	24,23
	Marco 1 elemento	1011 61 89	6,32	1011 61 84	8,42	1011 61 86	8,42
			<b>18,72</b>		<b>32,65</b>		<b>32,65</b>
<b>Marco</b>	2 elementos	1012 61 89	9,20	1012 61 84	13,18	1012 61 86	13,18
	3 elementos	1013 61 89	15,88	1013 61 84	21,20	1013 61 86	21,20
	4 elementos	1014 61 89	25,52	1014 61 84	34,16	1014 61 86	34,16
	5 elementos	1015 61 89	38,87	1015 61 84	51,97	1015 61 86	51,97

		aluminio/ blanco polar		acero/ blanco polar		cristal blanco polar		cristal antracita		pizarra/ antracita		hormigón/ blanco polar	
													
		Ref.	Precio	Ref.	Precio	Ref.	Precio	Ref.	Precio	Ref.	Precio	Ref.	Precio
<b>Interruptor</b>	Mecanismo	3031	4,91	3031	4,91	3031	4,91	3031	4,91	3031	4,91	3031	4,91
	Tecla	1620 60 89	2,81	1620 60 89	2,81	1620 60 89	2,81	1620 60 86	4,91	1620 60 86	4,91	1620 60 89	2,81
	Marco 1 elem.	1011 60 74	54,73	1011 60 83	54,73	1011 60 79	41,97	1011 60 76	41,97	1011 60 30	54,73	1011 60 20	54,73
			<b>62,45</b>		<b>62,45</b>		<b>49,69</b>		<b>51,79</b>		<b>64,55</b>		<b>62,45</b>
<b>Conmutador</b>	Mecanismo	3036	5,61	3036	5,61	3036	5,61	3036	5,61	3036	5,61	3036	5,61
	Tecla	1620 60 89	2,81	1620 60 89	2,81	1620 60 89	2,81	1620 60 86	4,91	1620 60 86	4,91	1620 60 89	2,81
	Marco 1 elem.	1011 60 74	54,73	1011 60 83	54,73	1011 60 79	41,97	1011 60 76	41,97	1011 60 30	54,73	1011 60 20	54,73
			<b>63,15</b>		<b>63,15</b>		<b>50,39</b>		<b>52,49</b>		<b>65,25</b>		<b>63,15</b>
<b>Cruza- miento</b>	Mecanismo	3037	11,63	3037	11,63	3037	11,63	3037	11,63	3037	11,63	3037	11,63
	Tecla	1620 60 89	2,81	1620 60 89	2,81	1620 60 89	2,81	1620 60 86	4,91	1620 60 86	4,91	1620 60 89	2,81
	Marco 1 elem.	1011 60 74	54,73	1011 60 83	54,73	1011 60 79	41,97	1011 60 76	41,97	1011 60 30	54,73	1011 60 20	54,73
			<b>69,17</b>		<b>69,17</b>		<b>56,41</b>		<b>58,51</b>		<b>71,27</b>		<b>69,17</b>
<b>Toma SCHUKO*</b>	Mecanismo	734123 60 89	10,06	734123 60 89	10,06	734123 60 89	10,06	7141 34	5,82	7141 34	5,82	734123 60 89	10,06
	Tapa							1719 60 86	6,97	1719 60 86	6,97		
	Marco 1 elem.	1011 60 74	54,73	1011 60 83	54,73	1011 60 79	41,97	1011 60 76	41,97	1011 60 30	54,73	1011 60 20	54,73
			<b>64,79</b>		<b>64,79</b>		<b>52,03</b>		<b>54,76</b>		<b>67,52</b>		<b>64,79</b>
<b>Pulsador</b>	Mecanismo	5031	6,02	5031	6,02	5031	6,02	5031	6,02	5031	6,02	5031	6,02
	Tecla	1620 60 89	2,81	1620 60 89	2,81	1620 60 89	2,81	1620 60 86	4,91	1620 60 86	4,91	1620 60 89	2,81
	Marco 1 elem.	1011 60 74	54,73	1011 60 83	54,73	1011 60 79	41,97	1011 60 76	41,97	1011 60 30	54,73	1011 60 20	54,73
			<b>63,56</b>		<b>63,56</b>		<b>50,80</b>		<b>52,90</b>		<b>65,66</b>		<b>63,56</b>
<b>Doble interruptor</b>	Mecanismo	3035	7,36	3035	7,36	3035	7,36	3035	7,36	3035	7,36	3035	7,36
	Tecla	1623 60 89	7,41	1623 60 89	7,41	1623 60 89	7,41	1623 60 86	8,51	1623 60 86	8,51	1623 60 89	7,41
	Marco 1 elem.	1011 60 74	54,73	1011 60 83	54,73	1011 60 79	41,97	1011 60 76	41,97	1011 60 30	54,73	1011 60 20	54,73
			<b>69,50</b>		<b>69,50</b>		<b>56,74</b>		<b>57,84</b>		<b>70,60</b>		<b>69,50</b>
<b>Doble conmutador</b>	Mecanismo	3038 08	18,30	3038 08	18,30	3038 08	18,30	3038 08	18,30	3038 08	18,30	3038 08	18,30
	Tecla	1623 60 89	7,41	1623 60 89	7,41	1623 60 89	7,41	1623 60 86	8,51	1623 60 86	8,51	1623 60 89	7,41
	Marco 1 elem.	1011 60 74	54,73	1011 60 83	54,73	1011 60 79	41,97	1011 60 76	41,97	1011 60 30	54,73	1011 60 20	54,73
			<b>80,44</b>		<b>80,44</b>		<b>67,68</b>		<b>68,78</b>		<b>81,54</b>		<b>80,44</b>
<b>Doble interruptor persianas</b>	Mecanismo	3035 20	16,94	3035 20	16,94	3035 20	16,94	3035 20	16,94	3035 20	16,94	3035 20	16,94
	Tecla doble c/flecha	1625 60 89	8,31	1625 60 89	8,31	1625 60 89	8,31	1625 60 86	11,46	1625 60 86	11,46	1625 60 89	8,31
	Marco 1 elem.	1011 60 74	54,73	1011 60 83	54,73	1011 60 79	41,97	1011 60 76	41,97	1011 60 30	54,73	1011 60 20	54,73
			<b>79,98</b>		<b>79,98</b>		<b>67,22</b>		<b>70,37</b>		<b>83,13</b>		<b>79,98</b>
<b>Doble pulsador persianas</b>	Mecanismo	5035 20	16,11	5035 20	16,11	5035 20	16,11	5035 20	16,11	5035 20	16,11	5035 20	16,11
	Tecla doble c/flecha	1625 60 89	8,31	1625 60 89	8,31	1625 60 89	8,31	1625 60 86	11,46	1625 60 86	11,46	1625 60 89	8,31
	Marco 1 elem.	1011 60 74	54,73	1011 60 83	54,73	1011 60 79	41,97	1011 60 76	41,97	1011 60 30	54,73	1011 60 20	54,73
			<b>79,15</b>		<b>79,15</b>		<b>66,39</b>		<b>69,54</b>		<b>82,30</b>		<b>79,15</b>
<b>Toma teléfono cat. 3</b>	Mecanismo	4538	11,61	4538	11,61	4538	11,61	4538	11,61	4538	11,61	4538	11,61
	Tapa	1407 60 89	6,39	1407 60 89	6,39	1407 60 89	6,39	1407 60 86	9,61	1407 60 86	9,61	1407 60 89	6,39
	Marco 1 elem.	1011 60 74	54,73	1011 60 83	54,73	1011 60 79	41,97	1011 60 76	41,97	1011 60 30	54,73	1011 60 20	54,73
			<b>72,73</b>		<b>72,73</b>		<b>59,97</b>		<b>63,19</b>		<b>75,95</b>		<b>72,73</b>
<b>Toma simple RJ45 cat. 6e</b>	Mecanismo	4554 01	28,10	4554 01	28,10	4554 01	28,10	4554 01	28,10	4554 01	28,10	4554 01	28,10
	Tapa	1407 60 89	6,39	1407 60 89	6,39	1407 60 89	6,39	1407 60 86	9,61	1407 60 86	9,61	1407 60 89	6,39
	Marco 1 elem.	1011 60 74	54,73	1011 60 83	54,73	1011 60 79	41,97	1011 60 76	41,97	1011 60 30	54,73	1011 60 20	54,73
			<b>89,22</b>		<b>89,22</b>		<b>76,46</b>		<b>79,68</b>		<b>92,44</b>		<b>89,22</b>
<b>Toma doble RJ45 cat. 6e</b>	Mecanismo	4555 01	36,15	4555 01	36,15	4555 01	36,15	4555 01	36,15	4555 01	36,15	4555 01	36,15
	Tapa	1409 60 89	6,39	1409 60 89	6,39	1409 60 89	6,39	1409 60 86	9,61	1409 60 86	9,61	1409 60 89	6,39
	Marco 1 elem.	1011 60 74	54,73	1011 60 83	54,73	1011 60 79	41,97	1011 60 76	41,97	1011 60 30	54,73	1011 60 20	54,73
			<b>97,27</b>		<b>97,27</b>		<b>84,51</b>		<b>87,73</b>		<b>100,49</b>		<b>97,27</b>
<b>Toma TV</b>	Mecanismo	4522 10	20,48	4522 10	20,48	4522 10	20,48	4522 10	20,48	4522 10	20,48	4522 10	20,48
	Tapa	1203 60 89	5,89	1203 60 89	5,89	1203 60 89	5,89	1203 60 86	9,61	1203 60 86	9,61	1203 60 89	5,89
	Marco 1 elem.	1011 60 74	54,73	1011 60 83	54,73	1011 60 79	41,97	1011 60 76	41,97	1011 60 30	54,73	1011 60 20	54,73
			<b>81,10</b>		<b>81,10</b>		<b>68,34</b>		<b>72,06</b>		<b>84,82</b>		<b>81,10</b>
<b>Salida de hilos</b>	Mecanismo	4470	13,40	4470	13,40	4470	13,40	4470	13,40	4470	13,40	4470	13,40
	Tapa	1019 60 89	8,07	1019 60 89	8,07	1019 60 89	8,07	1019 60 86	9,80	1019 60 86	9,80	1019 60 89	8,07
	Marco 1 elem.	1011 60 74	54,73	1011 60 83	54,73	1011 60 79	41,97	1011 60 76	41,97	1011 60 30	54,73	1011 60 20	54,73
			<b>76,20</b>		<b>76,20</b>		<b>63,44</b>		<b>65,17</b>		<b>77,93</b>		<b>76,20</b>
<b>Tapa ciega</b>	Mec. con tapa	1009 60 89	12,40	1009 60 89	12,40	1009 60 89	12,40	1009 60 86	24,23	1009 60 86	24,23	1009 60 89	12,40
	Marco 1 elem.	1011 60 74	54,73	1011 60 83	54,73	1011 60 79	41,97	1011 60 76	41,97	1011 60 30	54,73	1011 60 20	54,73
			<b>67,13</b>		<b>67,13</b>		<b>54,37</b>		<b>66,20</b>		<b>78,96</b>		<b>67,13</b>
<b>Marco horizontal</b>	2 elementos	1012 60 74	96,64	1022 60 83	96,64	1012 60 79	74,07	1012 60 76	74,07	1012 60 30	96,64	1012 60 20	96,64
	3 elementos	1013 60 74	161,58	1023 60 83	161,58	1013 60 79	123,87	1013 60 76	123,87	1013 60 30	161,58	1013 60 20	161,58
	4 elementos	1014 60 74	221,01	1024 60 83	221,01	1014 60 79	169,42	1014 60 76	169,42				
	5 elementos	1015 60 74	301,19	1025 60 83	301,19	1015 60 79	230,91	1015 60 76	230,91				
<b>Marco vertical</b>	2 elementos		1012 60 83	96,64									
	3 elementos		1013 60 83	161,58									
	4 elementos		1014 60 83	221,01									
	5 elementos		1015 60 83	301,19									

K.1 blanco polar

K.1 antracita









		Ref.	Precio	Ref.	Precio
<b>Interruptor</b>	Mecanismo	3031	4,91	3031	4,91
	Tecla	1405 70 09	3,08	1405 70 06	8,52
	Marco 1 elemento	1313 70 09	2,38	1313 70 06	4,60
			<b>10,37</b>		<b>18,03</b>
<b>Conmutador</b>	Mecanismo	3036	5,61	3036	5,61
	Tecla	1405 70 09	3,08	1405 70 06	8,52
	Marco 1 elemento	1313 70 09	2,38	1313 70 06	4,60
			<b>11,07</b>		<b>18,73</b>
<b>Cruzamiento</b>	Mecanismo	3037	11,63	3037	11,63
	Tecla	1405 70 09	3,08	1405 70 06	8,52
	Marco 1 elemento	1313 70 09	2,38	1313 70 06	4,60
			<b>17,09</b>		<b>24,75</b>
<b>Toma SCHUKO*</b>	Mecanismo	73 4135 70 09	10,82	7141 34	5,82
	Tapa			1719 70 06	5,90
	Marco 1 elemento	1313 70 09	2,38	1313 70 06	4,60
			<b>13,20</b>		<b>16,32</b>
<b>Pulsador</b>	Mecanismo	5031	6,02	5031	6,02
	Tecla	1405 70 09	3,08	1405 70 06	8,52
	Marco 1 elemento	1313 70 09	2,38	1313 70 06	4,60
			<b>11,48</b>		<b>19,14</b>
<b>Doble interruptor</b>	Mecanismo	3035	7,36	3035	7,36
	Tecla	1435 70 09	8,21	1435 70 06	12,03
	Marco 1 elemento	1313 70 09	2,38	1313 70 06	4,60
			<b>17,95</b>		<b>23,99</b>
<b>Doble conmutador</b>	Mecanismo	3038 08	18,30	3038 08	18,30
	Tecla	1435 70 09	8,21	1435 70 06	12,03
	Marco 1 elemento	1313 70 09	2,38	1313 70 06	4,60
			<b>28,89</b>		<b>34,93</b>
<b>Doble interruptor persianas</b>	Mecanismo	3035 20	16,94	3035 20	16,94
	Tecla doble con flecha	1435 71 09	9,74	1435 71 06	15,00
	Marco 1 elemento	1313 70 09	2,38	1313 70 06	4,60
			<b>29,06</b>		<b>36,54</b>
<b>Doble pulsador persianas</b>	Mecanismo	5035 20	16,11	5035 20	16,11
	Tecla doble con flecha	1435 71 09	9,74	1435 71 06	15,00
	Marco 1 elemento	1313 70 09	2,38	1313 70 06	4,60
			<b>28,23</b>		<b>35,71</b>
<b>Toma teléfono cat. 3</b>	Mecanismo	4538	11,61	4538	11,61
	Tapa	1407 70 09	6,95	1407 70 06	7,84
	Marco 1 elemento	1313 70 09	2,38	1313 70 06	4,60
			<b>20,94</b>		<b>24,05</b>
<b>Toma simple RJ45 cat. 6e</b>	Mecanismo	4554 01	28,10	4554 01	28,10
	Tapa	1407 70 09	6,95	1407 70 06	7,84
	Marco 1 elemento	1313 70 09	2,38	1313 70 06	4,60
			<b>37,43</b>		<b>40,54</b>
<b>Toma doble RJ45 cat. 6e</b>	Mecanismo	4555 01	36,15	4555 01	36,15
	Tapa	1409 70 09	8,65	1409 70 06	9,88
	Marco 1 elemento	1313 70 09	2,38	1313 70 06	4,60
			<b>47,18</b>		<b>50,63</b>
<b>Toma TV</b>	Mecanismo	4522 10	20,48	4522 10	20,48
	Tapa	1201 70 19	6,56	1201 70 16	9,88
	Marco 1 elemento	1313 70 09	2,38	1313 70 06	4,60
			<b>29,42</b>		<b>34,96</b>
<b>Salida de hilos</b>	Mecanismo	4470	13,40	4470	13,40
	Tapa	1005 70 09	8,37	1005 70 06	9,88
	Marco 1 elemento	1313 70 09	2,38	1313 70 06	4,60
			<b>24,15</b>		<b>27,88</b>
<b>Tapa ciega</b>	Mecanismo con tapa	1045 70 09	13,38	1045 70 06	15,00
	Marco 1 elemento	1313 70 09	2,38	1313 70 06	4,60
			<b>15,76</b>		<b>19,60</b>
<b>Marco horizontal</b>	2 elementos	1363 70 09	4,60	1363 70 06	7,00
	3 elementos	1373 70 09	6,84	1373 70 06	10,67
	4 elementos	1383 70 09	9,35	1383 70 06	17,28
	5 elementos	1393 70 09	15,20	1393 70 06	24,17
<b>Marco vertical</b>	2 elementos	1323 70 09	4,60	1323 70 06	7,00
	3 elementos	1333 70 09	6,84	1333 70 06	10,67
	4 elementos	1343 70 09	9,35	1343 70 06	17,28
	5 elementos	1353 70 09	15,20	1353 70 06	24,17

K.5 acero

K.5 aluminio



		Ref.	Precio	Ref.	Precio
<b>Interruptor</b>	Mecanismo	3031	4,91	3031	4,91
	Tecla	1405 70 04	8,66	1405 70 03	8,66
	Marco 1 elemento	1313 70 04	12,58	1313 70 03	12,58
			<b>26,15</b>		<b>26,15</b>
<b>Conmutador</b>	Mecanismo	3036	5,61	3036	5,61
	Tecla	1405 70 04	8,66	1405 70 03	8,66
	Marco 1 elemento	1313 70 04	12,58	1313 70 03	12,58
			<b>26,85</b>		<b>26,85</b>
<b>Cruzamiento</b>	Mecanismo	3037	11,63	3037	11,63
	Tecla	1405 70 04	8,66	1405 70 03	8,66
	Marco 1 elemento	1313 70 04	12,58	1313 70 03	12,58
			<b>32,87</b>		<b>32,87</b>
<b>Toma SCHUKO*</b>	Mecanismo	7141 34	5,82	7141 34	5,82
	Tapa	1719 70 04	10,40	1719 70 03	10,40
	Marco 1 elemento	1313 70 04	12,58	1313 70 03	12,58
			<b>28,80</b>		<b>28,80</b>
<b>Pulsador</b>	Mecanismo	5031	6,02	5031	6,02
	Tecla	1405 70 04	8,66	1405 70 03	8,66
	Marco 1 elemento	1313 70 04	12,58	1313 70 03	12,58
			<b>27,26</b>		<b>27,26</b>
<b>Doble interruptor</b>	Mecanismo	3035	7,36	3035	7,36
	Tecla	1435 70 04	12,17	1435 70 03	21,63
	Marco 1 elemento	1313 70 04	12,58	1313 70 03	12,58
			<b>32,11</b>		<b>41,57</b>
<b>Doble conmutador</b>	Mecanismo	3038 08	18,30	3038 08	18,30
	Tecla	1435 70 04	12,17	1435 70 03	21,63
	Marco 1 elemento	1313 70 04	12,58	1313 70 03	12,58
			<b>43,05</b>		<b>52,51</b>
<b>Doble interruptor persianas</b>	Mecanismo	3035 20	16,94	3035 20	16,94
	Tecla doble con flecha	1435 71 04	15,00	1435 71 03	15,00
	Marco 1 elemento	1313 70 04	12,58	1313 70 03	12,58
			<b>44,52</b>		<b>44,52</b>
<b>Doble pulsador persianas</b>	Mecanismo	5035 20	16,11	5035 20	16,11
	Tecla doble con flecha	1435 71 04	15,00	1435 71 03	15,00
	Marco 1 elemento	1313 70 04	12,58	1313 70 03	12,58
			<b>43,69</b>		<b>43,69</b>
<b>Toma teléfono cat. 3</b>	Mecanismo	4538	11,61	4538	11,61
	Tapa	1407 70 04	11,07	1407 70 03	11,07
	Marco 1 elemento	1313 70 04	12,58	1313 70 03	12,58
			<b>35,26</b>		<b>35,26</b>
<b>Toma simple RJ45 cat. 6e</b>	Mecanismo	4554 01	28,10	4554 01	28,10
	Tapa	1407 70 04	11,07	1407 70 03	11,07
	Marco 1 elemento	1313 70 04	12,58	1313 70 03	12,58
			<b>51,75</b>		<b>51,75</b>
<b>Toma doble RJ45 cat. 6e</b>	Mecanismo	4555 01	36,15	4555 01	36,15
	Tapa	1409 70 04	13,93	1409 70 03	13,93
	Marco 1 elemento	1313 70 04	12,58	1313 70 03	12,58
			<b>62,66</b>		<b>62,66</b>
<b>Toma TV</b>	Mecanismo	4522 10	20,48	4522 10	20,48
	Tapa	1201 70 14	13,88	1201 70 13	13,88
	Marco 1 elemento	1313 70 04	12,58	1313 70 03	12,58
			<b>46,94</b>		<b>46,94</b>
<b>Salida de hilos</b>	Mecanismo	4470	13,40	4470	13,40
	Tapa	1005 70 04	19,22	1005 70 03	19,22
	Marco 1 elemento	1313 70 04	12,58	1313 70 03	12,58
			<b>45,20</b>		<b>45,20</b>
<b>Tapa ciega</b>	Mecanismo con tapa	1045 70 04	19,07	1045 70 03	19,07
	Marco 1 elemento	1313 70 04	12,58	1313 70 03	12,58
			<b>31,65</b>		<b>31,65</b>
<b>Marco horizontal</b>	2 elementos	1363 70 04	20,17	1363 70 03	20,17
	3 elementos	1373 70 04	43,74	1373 70 03	43,74
	4 elementos	1383 70 04	50,28	1383 70 03	50,28
	5 elementos	1393 70 04	79,08	1393 70 03	79,08
<b>Marco vertical</b>	2 elementos	1323 70 04	20,17	1323 70 03	20,17
	3 elementos	1333 70 04	43,74	1333 70 03	43,74
	4 elementos	1343 70 04	50,28	1343 70 03	50,28
	5 elementos	1353 70 04	79,08	1353 70 03	79,08

		blanco polar, brillo		negro brillo		aluminio / blanco polar, brillo		aluminio / negro, brillo		acero / blanco polar, brillo		acero negro, brillo	
													
		Ref.	Precio	Ref.	Precio	Ref.	Precio	Ref.	Precio	Ref.	Precio	Ref.	Precio
<b>Interrup-tor</b>	Mecanismo	3031	4,91	3031	4,91	3031	4,91	3031	4,91	3031	4,91	3031	4,91
	Tecla	1620 20 89	2,99	1620 20 45	6,41	1620 20 89	2,99	1620 20 45	6,41	1620 20 89	2,99	1620 20 45	6,41
	Marco 1 elem.	1011 21 89	3,13	1011 21 45	5,85	1011 21 74	51,58	1011 21 84	51,58	1011 21 14	58,02	1011 21 04	58,02
			<b>11,03</b>		<b>17,17</b>		<b>59,48</b>		<b>62,90</b>		<b>65,92</b>		<b>69,34</b>
<b>Conmu-tador</b>	Mecanismo	3036	5,61	3036	5,61	3036	5,61	3036	5,61	3036	5,61	3036	5,61
	Tecla	1620 20 89	2,99	1620 20 45	6,41	1620 20 89	2,99	1620 20 45	6,41	1620 20 89	2,99	1620 20 45	6,41
	Marco 1 elem.	1011 21 89	3,13	1011 21 45	5,85	1011 21 74	51,58	1011 21 84	51,58	1011 21 14	58,02	1011 21 04	58,02
			<b>11,73</b>		<b>17,87</b>		<b>60,18</b>		<b>63,60</b>		<b>66,62</b>		<b>70,04</b>
<b>Cruza-miento</b>	Mecanismo	3037	11,63	3037	11,63	3037	11,63	3037	11,63	3037	11,63	3037	11,63
	Tecla	1620 20 89	2,99	1620 20 45	6,41	1620 20 89	2,99	1620 20 45	6,41	1620 20 89	2,99	1620 20 45	6,41
	Marco 1 elem.	1011 21 89	3,13	1011 21 45	5,85	1011 21 74	51,58	1011 21 84	51,58	1011 21 14	58,02	1011 21 04	58,02
			<b>17,75</b>		<b>23,89</b>		<b>66,20</b>		<b>69,62</b>		<b>72,64</b>		<b>76,06</b>
<b>Toma SCHUKO*</b>	Mecanismo	7341232089	10,28	7141 34	5,82	7341232089	10,28	7141 34	5,82	7341232089	10,28	7141 34	5,82
	Tapa	1719 20 89	5,60	1719 20 45	5,60	1719 20 89	5,60	1719 20 45	5,60	1719 20 89	5,60	1719 20 45	5,60
	Marco 1 elem.	1011 21 89	3,13	1011 21 45	5,85	1011 21 74	51,58	1011 21 84	51,58	1011 21 14	58,02	1011 21 04	58,02
			<b>13,41</b>		<b>17,27</b>		<b>61,86</b>		<b>63,00</b>		<b>68,30</b>		<b>69,44</b>
<b>Pulsador</b>	Mecanismo	5031	6,02	5031	6,02	5031	6,02	5031	6,02	5031	6,02	5031	6,02
	Tecla	1620 20 89	2,99	1620 20 45	6,41	1620 20 89	2,99	1620 20 45	6,41	1620 20 89	2,99	1620 20 45	6,41
	Marco 1 elem.	1011 21 89	3,13	1011 21 45	5,85	1011 21 74	51,58	1011 21 84	51,58	1011 21 14	58,02	1011 21 04	58,02
			<b>12,14</b>		<b>18,28</b>		<b>60,59</b>		<b>64,01</b>		<b>67,03</b>		<b>70,45</b>
<b>Doble interrup-tor</b>	Mecanismo	3035	7,36	3035	7,36	3035	7,36	3035	7,36	3035	7,36	3035	7,36
	Tecla	1623 20 89	4,23	1623 20 45	9,12	1623 20 89	4,23	1623 20 45	9,12	1623 20 89	4,23	1623 20 45	9,12
	Marco 1 elem.	1011 21 89	3,13	1011 21 45	5,85	1011 21 74	51,58	1011 21 84	51,58	1011 21 14	58,02	1011 21 04	58,02
			<b>14,72</b>		<b>22,33</b>		<b>63,17</b>		<b>68,06</b>		<b>69,61</b>		<b>74,50</b>
<b>Doble conmu-tador</b>	Mecanismo	3038 08	18,30	3038 08	18,30	3038 08	18,30	3038 08	18,30	3038 08	18,30	3038 08	18,30
	Tecla	1623 20 89	4,23	1623 20 45	9,12	1623 20 89	4,23	1623 20 45	9,12	1623 20 89	4,23	1623 20 45	9,12
	Marco 1 elem.	1011 21 89	3,13	1011 21 45	5,85	1011 21 74	51,58	1011 21 84	51,58	1011 21 14	58,02	1011 21 04	58,02
			<b>25,66</b>		<b>33,27</b>		<b>74,11</b>		<b>79,00</b>		<b>80,55</b>		<b>85,44</b>
<b>Doble interrup-tor persianas</b>	Mecanismo	3035 20	16,94	3035 20	16,94	3035 20	16,94	3035 20	16,94	3035 20	16,94	3035 20	16,94
	Tecla doble c/flecha	1625 20 89	5,25	1625 20 45	11,29	1625 20 89	5,25	1625 20 45	11,29	1625 20 89	5,25	1625 20 45	11,29
	Marco 1 elem.	1011 21 89	3,13	1011 21 45	5,85	1011 21 74	51,58	1011 21 84	51,58	1011 21 14	58,02	1011 21 04	58,02
			<b>25,32</b>		<b>34,08</b>		<b>73,77</b>		<b>79,81</b>		<b>80,21</b>		<b>86,25</b>
<b>Doble pulsador persianas</b>	Mecanismo	5035 20	16,11	5035 20	16,11	5035 20	16,11	5035 20	16,11	5035 20	16,11	5035 20	16,11
	Tecla doble c/flecha	1625 20 89	5,25	1625 20 45	11,29	1625 20 89	5,25	1625 20 45	11,29	1625 20 89	5,25	1625 20 45	11,29
	Marco 1 elem.	1011 21 89	3,13	1011 21 45	5,85	1011 21 74	51,58	1011 21 84	51,58	1011 21 14	58,02	1011 21 04	58,02
			<b>24,49</b>		<b>33,25</b>		<b>72,94</b>		<b>78,98</b>		<b>79,38</b>		<b>85,42</b>
<b>Toma teléfono cat. 3</b>	Mecanismo	4538	11,61	4538	11,61	4538	11,61	4538	11,61	4538	11,61	4538	11,61
	Tapa	1407 20 89	6,71	1407 20 45	7,25	1407 20 89	6,71	1407 20 45	7,25	1407 20 89	6,71	1407 20 45	7,25
	Marco 1 elem.	1011 21 89	3,13	1011 21 45	5,85	1011 21 74	51,58	1011 21 84	51,58	1011 21 14	58,02	1011 21 04	58,02
			<b>21,45</b>		<b>24,71</b>		<b>69,90</b>		<b>70,44</b>		<b>76,34</b>		<b>76,88</b>
<b>Toma simple RJ45 cat. 6e</b>	Mecanismo	4554 01	28,10	4554 01	28,10	4554 01	28,10	4554 01	28,10	4554 01	28,10	4554 01	28,10
	Tapa	1407 20 89	6,71	1407 20 45	7,25	1407 20 89	6,71	1407 20 45	7,25	1407 20 89	6,71	1407 20 45	7,25
	Marco 1 elem.	1011 21 89	3,13	1011 21 45	5,85	1011 21 74	51,58	1011 21 84	51,58	1011 21 14	58,02	1011 21 04	58,02
			<b>37,94</b>		<b>41,20</b>		<b>86,39</b>		<b>86,93</b>		<b>92,83</b>		<b>93,37</b>
<b>Toma doble RJ45 cat. 6e</b>	Mecanismo	4555 01	36,15	4555 01	36,15	4555 01	36,15	4555 01	36,15	4555 01	36,15	4555 01	36,15
	Tapa	1409 20 89	6,71	1409 20 45	7,25	1409 20 89	6,71	1409 20 45	7,25	1409 20 89	6,71	1409 20 45	7,25
	Marco 1 elem.	1011 21 89	3,13	1011 21 45	5,85	1011 21 74	51,58	1011 21 84	51,58	1011 21 14	58,02	1011 21 04	58,02
			<b>45,99</b>		<b>49,25</b>		<b>94,44</b>		<b>94,98</b>		<b>100,88</b>		<b>101,42</b>
<b>Toma TV</b>	Mecanismo	4522 10	20,48	4522 10	20,48	4522 10	20,48	4522 10	20,48	4522 10	20,48	4522 10	20,48
	Tapa	1203 20 89	6,71	1203 20 45	7,25	1203 20 89	6,71	1203 20 45	7,25	1203 20 89	6,71	1203 20 45	7,25
	Marco 1 elem.	1011 21 89	3,13	1011 21 45	5,85	1011 21 74	51,58	1011 21 84	51,58	1011 21 14	58,02	1011 21 04	58,02
			<b>30,32</b>		<b>33,58</b>		<b>78,77</b>		<b>79,31</b>		<b>85,21</b>		<b>85,75</b>
<b>Salida de hilos</b>	Mecanismo	4470	13,40	4470	13,40	4470	13,40	4470	13,40	4470	13,40	4470	13,40
	Tapa	1019 20 89	6,71	1019 20 45	7,25	1019 20 89	6,71	1019 20 45	7,25	1019 20 89	6,71	1019 20 45	7,25
	Marco 1 elem.	1011 21 89	3,13	1011 21 45	5,85	1011 21 74	51,58	1011 21 84	51,58	1011 21 14	58,02	1011 21 04	58,02
			<b>23,24</b>		<b>26,50</b>		<b>71,69</b>		<b>72,23</b>		<b>78,13</b>		<b>78,67</b>
<b>Tapa ciega</b>	Mec. con tapa	1009 20 89	10,62	1009 20 45	11,31	1009 20 89	10,62	1009 20 45	11,31	1009 20 89	10,62	1009 20 45	11,31
	Marco 1 elem.	1011 21 89	3,13	1011 21 45	5,85	1011 21 74	51,58	1011 21 84	51,58	1011 21 14	58,02	1011 21 04	58,02
				<b>13,75</b>		<b>17,16</b>		<b>62,20</b>		<b>62,89</b>		<b>68,64</b>	
<b>Marco</b>	2 elementos	1012 21 89	5,16	1012 21 45	8,46	1012 21 74	91,05	1012 21 84	91,05	1012 21 14	102,43	1012 21 04	102,43
	3 elementos	1013 21 89	9,13	1013 21 45	13,61	1013 21 74	103,73	1013 21 84	99,38	1013 21 14	171,27	1013 21 04	171,27
	4 elementos	1014 21 89	12,75	1014 21 45	22,07	1014 21 74	141,88	1014 21 84	135,95	1014 21 14	234,27	1014 21 04	234,27
	5 elementos	1015 21 89	20,89	1015 21 45	30,86	1015 21 74	193,38	1015 21 84	185,28	1015 21 14	319,30	1015 21 04	319,30

crystal  
blanco polar



crystal  
negro



### Nota:

La gama berker R.1 está disponible también en los siguientes acabados:

pizarra  
blanco polar



pizarra  
negro



hormigón  
blanco polar



hormigón  
negro



piel marrón  
blanco polar



piel marrón  
negro



madera  
blanco polar



madera  
negro



acrílico rojo  
blanco polar



acrílico rojo  
negro

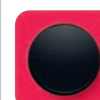







acrílico  
naranja  
blanco polar



acrílico  
naranja  
negro



		Ref.	Precio	Ref.	Precio
<b>Interruptor</b>	Mecanismo	3031	4,91	3031	4,91
	Tecla	1620 20 89	2,99	1620 20 45	6,41
	Marco 1 elemento	1011 21 09	38,67	1011 21 16	38,67
			<b>46,57</b>		<b>49,99</b>
<b>Conmutador</b>	Mecanismo	3036	5,61	3036	5,61
	Tecla	1620 20 89	2,99	1620 20 45	6,41
	Marco 1 elemento	1011 21 09	38,67	1011 21 16	38,67
			<b>47,27</b>		<b>50,69</b>
<b>Cruzamiento</b>	Mecanismo	3037	11,63	3037	11,63
	Tecla	1620 20 89	2,99	1620 20 45	6,41
	Marco 1 elemento	1011 21 09	38,67	1011 21 16	38,67
			<b>53,29</b>		<b>56,71</b>
<b>Toma SCHUKO*</b>	Mecanismo	73 4123 20 89	10,28	7141 34	5,82
	Tapa			1719 20 45	5,60
	Marco 1 elemento	1011 21 09	38,67	1011 21 16	38,67
			<b>48,95</b>		<b>50,09</b>
<b>Pulsador</b>	Mecanismo	5031	6,02	5031	6,02
	Tecla	1620 20 89	2,99	1620 20 45	6,41
	Marco 1 elemento	1011 21 09	38,67	1011 21 16	38,67
			<b>47,68</b>		<b>51,10</b>
<b>Doble interruptor</b>	Mecanismo	3035	7,36	3035	7,36
	Tecla	1623 20 89	4,23	1623 20 45	9,12
	Marco 1 elemento	1011 21 09	38,67	1011 21 16	38,67
			<b>50,26</b>		<b>55,15</b>
<b>Doble conmutador</b>	Mecanismo	3038 08	18,30	3038 08	18,30
	Tecla	1623 20 89	4,23	1623 20 45	9,12
	Marco 1 elemento	1011 21 09	38,67	1011 21 16	38,67
			<b>61,20</b>		<b>66,09</b>
<b>Doble interruptor persianas</b>	Mecanismo	3035 20	16,94	3035 20	16,94
	Tecla doble con flecha	1625 20 89	5,25	1625 20 45	11,29
	Marco 1 elemento	1011 21 09	38,67	1011 21 16	38,67
			<b>60,86</b>		<b>66,90</b>
<b>Doble pulsador persianas</b>	Mecanismo	5035 20	16,11	5035 20	16,11
	Tecla doble con flecha	1625 20 89	5,25	1625 20 45	11,29
	Marco 1 elemento	1011 21 09	38,67	1011 21 16	38,67
			<b>60,03</b>		<b>66,07</b>
<b>Toma teléfono cat. 3</b>	Mecanismo	4538	11,61	4538	11,61
	Tapa	1407 20 89	6,71	1407 20 45	7,25
	Marco 1 elemento	1011 21 09	38,67	1011 21 16	38,67
			<b>56,99</b>		<b>57,53</b>
<b>Toma simple RJ45 cat. 6e</b>	Mecanismo	4554 01	28,10	4554 01	28,10
	Tapa	1407 20 89	6,71	1407 20 45	7,25
	Marco 1 elemento	1011 21 09	38,67	1011 21 16	38,67
			<b>73,48</b>		<b>74,02</b>
<b>Toma doble RJ45 cat. 6e</b>	Mecanismo	4555 01	36,15	4555 01	36,15
	Tapa	1409 20 89	6,71	1409 20 45	7,25
	Marco 1 elemento	1011 21 09	38,67	1011 21 16	38,67
			<b>81,53</b>		<b>82,07</b>
<b>Toma TV</b>	Mecanismo	4522 10	20,48	4522 10	20,48
	Tapa	1203 20 89	6,71	1203 20 45	7,25
	Marco 1 elemento	1011 21 09	38,67	1011 21 16	38,67
			<b>65,86</b>		<b>66,40</b>
<b>Salida de hilos</b>	Mecanismo	4470	13,40	4470	13,40
	Tapa	1019 20 89	6,71	1019 20 45	7,25
	Marco 1 elemento	1011 21 09	38,67	1011 21 16	38,67
			<b>58,78</b>		<b>59,32</b>
<b>Tapa ciega</b>	Mec. con tapa	1009 20 89	10,62	1009 20 45	11,31
	Marco 1 elemento	1011 21 09	38,67	1011 21 16	38,67
			<b>49,29</b>		<b>49,98</b>
<b>Marco</b>	2 elementos	1012 21 09	68,30	1012 21 16	68,30
	3 elementos	1013 21 09	89,92	1013 21 16	88,75
	4 elementos	1014 21 09	122,99	1014 21 16	121,40
	5 elementos	1015 21 09	167,62	1015 21 16	165,43

		blanco polar, brillo		negro brillo		aluminio / blanco polar, brillo		aluminio / negro, brillo		acero / blanco polar, brillo		acero negro, brillo	
													
		Ref.	Precio	Ref.	Precio	Ref.	Precio	Ref.	Precio	Ref.	Precio	Ref.	Precio
<b>Interrup-tor</b>	Mecanismo	3031	4,91	3031	4,91	3031	4,91	3031	4,91	3031	4,91	3031	4,91
	Tecla	1620 20 89	2,99	1620 20 45	6,41	1620 20 89	2,99	1620 20 45	6,41	1620 20 89	2,99	1620 20 45	6,41
	Marco 1 elem.	1011 22 89	3,13	1011 22 45	5,85	1011 22 74	51,58	1011 22 84	51,58	1011 22 14	58,02	1011 22 04	58,02
			<b>11,03</b>		<b>17,17</b>		<b>59,48</b>		<b>62,90</b>		<b>65,92</b>		<b>69,34</b>
<b>Conmu-tador</b>	Mecanismo	3036	5,61	3036	5,61	3036	5,61	3036	5,61	3036	5,61	3036	5,61
	Tecla	1620 20 89	2,99	1620 20 45	6,41	1620 20 89	2,99	1620 20 45	6,41	1620 20 89	2,99	1620 20 45	6,41
	Marco 1 elem.	1011 22 89	3,13	1011 22 45	5,85	1011 22 74	51,58	1011 22 84	51,58	1011 22 14	58,02	1011 22 04	58,02
			<b>11,73</b>		<b>17,87</b>		<b>60,18</b>		<b>63,60</b>		<b>66,62</b>		<b>70,04</b>
<b>Cruza-miento</b>	Mecanismo	3037	11,63	3037	11,63	3037	11,63	3037	11,63	3037	11,63	3037	11,63
	Tecla	1620 20 89	2,99	1620 20 45	6,41	1620 20 89	2,99	1620 20 45	6,41	1620 20 89	2,99	1620 20 45	6,41
	Marco 1 elem.	1011 22 89	3,13	1011 22 45	5,85	1011 22 74	51,58	1011 22 84	51,58	1011 22 14	58,02	1011 22 04	58,02
			<b>17,75</b>		<b>23,89</b>		<b>66,20</b>		<b>69,62</b>		<b>72,64</b>		<b>76,06</b>
<b>Toma SCHUKO*</b>	Mecanismo	7341232089	10,28	7141 34	5,82	7341232089	10,28	7141 34	5,82	7341232089	10,28	7141 34	5,82
	Tapa			1719 20 45	5,60			1719 20 45	5,60			1719 20 45	5,60
	Marco 1 elem.	1011 22 89	3,13	1011 22 45	5,85	1011 22 74	51,58	1011 22 84	51,58	1011 22 14	58,02	1011 22 04	58,02
			<b>13,41</b>		<b>17,27</b>		<b>61,86</b>		<b>63,00</b>		<b>68,30</b>		<b>69,44</b>
<b>Pulsador</b>	Mecanismo	5031	6,02	5031	6,02	5031	6,02	5031	6,02	5031	6,02	5031	6,02
	Tecla	1620 20 89	2,99	1620 20 45	6,41	1620 20 89	2,99	1620 20 45	6,41	1620 20 89	2,99	1620 20 45	6,41
	Marco 1 elem.	1011 22 89	3,13	1011 22 45	5,85	1011 22 74	51,58	1011 22 84	51,58	1011 22 14	58,02	1011 22 04	58,02
			<b>12,14</b>		<b>18,28</b>		<b>60,59</b>		<b>64,01</b>		<b>67,03</b>		<b>70,45</b>
<b>Doble interrup-tor</b>	Mecanismo	3035	7,36	3035	7,36	3035	7,36	3035	7,36	3035	7,36	3035	7,36
	Tecla	1623 20 89	4,23	1623 20 45	9,12	1623 20 89	4,23	1623 20 45	9,12	1623 20 89	4,23	1623 20 45	9,12
	Marco 1 elem.	1011 22 89	3,13	1011 22 45	5,85	1011 22 74	51,58	1011 22 84	51,58	1011 22 14	58,02	1011 22 04	58,02
			<b>14,72</b>		<b>22,33</b>		<b>63,17</b>		<b>68,06</b>		<b>69,61</b>		<b>74,50</b>
<b>Doble conmu-tador</b>	Mecanismo	3038 08	18,30	3038 08	18,30	3038 08	18,30	3038 08	18,30	3038 08	18,30	3038 08	18,30
	Tecla	1623 20 89	4,23	1623 20 45	9,12	1623 20 89	4,23	1623 20 45	9,12	1623 20 89	4,23	1623 20 45	9,12
	Marco 1 elem.	1011 22 89	3,13	1011 22 45	5,85	1011 22 74	51,58	1011 22 84	51,58	1011 22 14	58,02	1011 22 04	58,02
			<b>25,66</b>		<b>33,27</b>		<b>74,11</b>		<b>79,00</b>		<b>80,55</b>		<b>85,44</b>
<b>Doble interrup-tor persianas</b>	Mecanismo	3035 20	16,94	3035 20	16,94	3035 20	16,94	3035 20	16,94	3035 20	16,94	3035 20	16,94
	Tecla doble c/flecha	1625 20 89	5,25	1625 20 45	11,29	1625 20 89	5,25	1625 20 45	11,29	1625 20 89	5,25	1625 20 45	11,29
	Marco 1 elem.	1011 22 89	3,13	1011 22 45	5,85	1011 22 74	51,58	1011 22 84	51,58	1011 22 14	58,02	1011 22 04	58,02
			<b>25,32</b>		<b>34,08</b>		<b>73,77</b>		<b>79,81</b>		<b>80,21</b>		<b>86,25</b>
<b>Doble pulsador persianas</b>	Mecanismo	5035 20	16,11	5035 20	16,11	5035 20	16,11	5035 20	16,11	5035 20	16,11	5035 20	16,11
	Tecla doble c/flecha	1625 20 89	5,25	1625 20 45	11,29	1625 20 89	5,25	1625 20 45	11,29	1625 20 89	5,25	1625 20 45	11,29
	Marco 1 elem.	1011 22 89	3,13	1011 22 45	5,85	1011 22 74	51,58	1011 22 84	51,58	1011 22 14	58,02	1011 22 04	58,02
			<b>24,49</b>		<b>33,25</b>		<b>72,94</b>		<b>78,98</b>		<b>79,38</b>		<b>85,42</b>
<b>Toma teléfono cat. 3</b>	Mecanismo	4538	11,61	4538	11,61	4538	11,61	4538	11,61	4538	11,61	4538	11,61
	Tapa	1407 20 89	6,71	1407 20 45	7,25	1407 20 89	6,71	1407 20 45	7,25	1407 20 89	6,71	1407 20 45	7,25
	Marco 1 elem.	1011 22 89	3,13	1011 22 45	5,85	1011 22 74	51,58	1011 22 84	51,58	1011 22 14	58,02	1011 22 04	58,02
			<b>21,45</b>		<b>24,71</b>		<b>69,90</b>		<b>70,44</b>		<b>76,34</b>		<b>76,88</b>
<b>Toma simple RJ45 cat. 6e</b>	Mecanismo	4554 01	28,10	4554 01	28,10	4554 01	28,10	4554 01	28,10	4554 01	28,10	4554 01	28,10
	Tapa	1407 20 89	6,71	1407 20 45	7,25	1407 20 89	6,71	1407 20 45	7,25	1407 20 89	6,71	1407 20 45	7,25
	Marco 1 elem.	1011 22 89	3,13	1011 22 45	5,85	1011 22 74	51,58	1011 22 84	51,58	1011 22 14	58,02	1011 22 04	58,02
			<b>37,94</b>		<b>41,20</b>		<b>86,39</b>		<b>86,93</b>		<b>92,83</b>		<b>93,37</b>
<b>Toma doble RJ45 cat. 6e</b>	Mecanismo	4555 01	36,15	4555 01	36,15	4555 01	36,15	4555 01	36,15	4555 01	36,15	4555 01	36,15
	Tapa	1409 20 89	6,71	1409 20 45	7,25	1409 20 89	6,71	1409 20 45	7,25	1409 20 89	6,71	1409 20 45	7,25
	Marco 1 elem.	1011 22 89	3,13	1011 22 45	5,85	1011 22 74	51,58	1011 22 84	51,58	1011 22 14	58,02	1011 22 04	58,02
			<b>45,99</b>		<b>49,25</b>		<b>94,44</b>		<b>94,98</b>		<b>100,88</b>		<b>101,42</b>
<b>Toma TV</b>	Mecanismo	4522 10	20,48	4522 10	20,48	4522 10	20,48	4522 10	20,48	4522 10	20,48	4522 10	20,48
	Tapa	1203 20 89	6,71	1203 20 45	7,25	1203 20 89	6,71	1203 20 45	7,25	1203 20 89	6,71	1203 20 45	7,25
	Marco 1 elem.	1011 22 89	3,13	1011 22 45	5,85	1011 22 74	51,58	1011 22 84	51,58	1011 22 14	58,02	1011 22 04	58,02
			<b>30,32</b>		<b>33,58</b>		<b>78,77</b>		<b>79,31</b>		<b>85,21</b>		<b>85,75</b>
<b>Salida de hilos</b>	Mecanismo	4470	13,40	4470	13,40	4470	13,40	4470	13,40	4470	13,40	4470	13,40
	Tapa	1019 20 89	6,71	1019 20 45	7,25	1019 20 89	6,71	1019 20 45	7,25	1019 20 89	6,71	1019 20 45	7,25
	Marco 1 elem.	1011 22 89	3,13	1011 22 45	5,85	1011 22 74	51,58	1011 22 84	51,58	1011 22 14	58,02	1011 22 04	58,02
			<b>23,24</b>		<b>26,50</b>		<b>71,69</b>		<b>72,23</b>		<b>78,13</b>		<b>78,67</b>
<b>Tapa ciega</b>	Mec. con tapa	1009 20 89	10,62	1009 20 45	11,31	1009 20 89	10,62	1009 20 45	11,31	1009 20 89	10,62	1009 20 45	11,31
	Marco 1 elem.	1011 22 89	3,13	1011 22 45	5,85	1011 22 74	51,58	1011 22 84	51,58	1011 22 14	58,02	1011 22 04	58,02
				<b>13,75</b>		<b>17,16</b>		<b>62,20</b>		<b>62,89</b>		<b>68,64</b>	
<b>Marco</b>	2 elementos	1012 22 89	5,16	1012 22 45	8,46	1012 22 74	91,05	1012 22 84	91,05	1012 22 14	102,43	1012 22 04	102,43
	3 elementos	1013 22 89	9,13	1013 22 45	13,61	1013 22 74	103,73	1013 22 84	99,38	1013 22 14	171,27	1013 22 04	171,27
	4 elementos	1014 22 89	12,75	1014 22 45	22,07	1014 22 74	141,88	1014 22 84	135,95	1014 22 14	234,27	1014 22 04	234,27
	5 elementos	1015 22 89	20,89	1015 22 45	30,86	1015 22 74	193,38	1015 22 84	185,28	1015 22 14	319,30	1015 22 04	319,30

crystal  
blanco polar



crystal  
negro



		Ref.	Precio	Ref.	Precio
<b>Interruptor</b>	Mecanismo	3031	4,91	3031	4,91
	Tecla	1620 20 89	2,99	1620 20 45	6,41
	Marco 1 elemento	1011 22 09	38,67	1011 22 16	38,67
			<b>46,57</b>		<b>49,99</b>
<b>Conmutador</b>	Mecanismo	3036	5,61	3036	5,61
	Tecla	1620 20 89	2,99	1620 20 45	6,41
	Marco 1 elemento	1011 22 09	38,67	1011 22 16	38,67
			<b>47,27</b>		<b>50,69</b>
<b>Cruzamiento</b>	Mecanismo	3037	11,63	3037	11,63
	Tecla	1620 20 89	2,99	1620 20 45	6,41
	Marco 1 elemento	1011 22 09	38,67	1011 22 16	38,67
			<b>53,29</b>		<b>56,71</b>
<b>Toma SCHUKO*</b>	Mecanismo	73 4123 20 89	10,28	7141 34	5,82
	Tapa			1719 20 45	5,60
	Marco 1 elemento	1011 22 09	38,67	1011 22 16	38,67
			<b>48,95</b>		<b>50,09</b>
<b>Pulsador</b>	Mecanismo	5031	6,02	5031	6,02
	Tecla	1620 20 89	2,99	1620 20 45	6,41
	Marco 1 elemento	1011 22 09	38,67	1011 22 16	38,67
			<b>47,68</b>		<b>51,10</b>
<b>Doble interruptor</b>	Mecanismo	3035	7,36	3035	7,36
	Tecla	1623 20 89	4,23	1623 20 45	9,12
	Marco 1 elemento	1011 22 09	38,67	1011 22 16	38,67
			<b>50,26</b>		<b>55,15</b>
<b>Doble conmutador</b>	Mecanismo	3038 08	18,30	3038 08	18,30
	Tecla	1623 20 89	4,23	1623 20 45	9,12
	Marco 1 elemento	1011 22 09	38,67	1011 22 16	38,67
			<b>61,20</b>		<b>66,09</b>
<b>Doble interruptor persianas</b>	Mecanismo	3035 20	16,94	3035 20	16,94
	Tecla doble con flecha	1625 20 89	5,25	1625 20 45	11,29
	Marco 1 elemento	1011 22 09	38,67	1011 22 16	38,67
			<b>60,86</b>		<b>66,90</b>
<b>Doble pulsador persianas</b>	Mecanismo	5035 20	16,11	5035 20	16,11
	Tecla doble con flecha	1625 20 89	5,25	1625 20 45	11,29
	Marco 1 elemento	1011 22 09	38,67	1011 22 16	38,67
			<b>60,03</b>		<b>66,07</b>
<b>Toma teléfono cat. 3</b>	Mecanismo	4538	11,61	4538	11,61
	Tapa	1407 20 89	6,71	1407 20 45	7,25
	Marco 1 elemento	1011 22 09	38,67	1011 22 16	38,67
			<b>56,99</b>		<b>57,53</b>
<b>Toma simple RJ45 cat. 6e</b>	Mecanismo	4554 01	28,10	4554 01	28,10
	Tapa	1407 20 89	6,71	1407 20 45	7,25
	Marco 1 elemento	1011 22 09	38,67	1011 22 16	38,67
			<b>73,48</b>		<b>74,02</b>
<b>Toma doble RJ45 cat. 6e</b>	Mecanismo	4555 01	36,15	4555 01	36,15
	Tapa	1409 20 89	6,71	1409 20 45	7,25
	Marco 1 elemento	1011 22 09	38,67	1011 22 16	38,67
			<b>81,53</b>		<b>82,07</b>
<b>Toma TV</b>	Mecanismo	4522 10	20,48	4522 10	20,48
	Tapa	1203 20 89	6,71	1203 20 45	7,25
	Marco 1 elemento	1011 22 09	38,67	1011 22 16	38,67
			<b>65,86</b>		<b>66,40</b>
<b>Salida de hilos</b>	Mecanismo	4470	13,40	4470	13,40
	Tapa	1019 20 89	6,71	1019 20 45	7,25
	Marco 1 elemento	1011 22 09	38,67	1011 22 16	38,67
			<b>58,78</b>		<b>59,32</b>
<b>Tapa ciega</b>	Mecanismo con tapa	1009 20 89	10,62	1009 20 45	11,31
	Marco 1 elemento	1011 22 09	38,67	1011 22 16	38,67
			<b>49,29</b>		<b>49,98</b>
<b>Marco</b>	2 elementos	1012 22 09	68,30	1012 22 16	68,30
	3 elementos	1013 22 09	89,92	1013 22 16	88,75
	4 elementos	1014 22 09	122,99	1014 22 16	121,40
	5 elementos	1015 22 09	167,62	1015 22 16	165,43



# R.8

## Menos es más







Si bien su aspecto exterior es muy reducido, la nueva serie berker R.8 ofrece numerosas posibilidades de diseño. Sus marcos, disponibles en acero inoxidable, aluminio o cristal, se pueden combinar con las teclas de las series berker R.1 y berker R.3, ofreciendo así una gran flexibilidad. ¡Y todo en tan solo 3 milímetros de espesor!

[hager.es/berker](http://hager.es/berker)









Cajas empotradas para paredes huecas y de obra.



**:hager**

		cristal blanco polar, brillo		cristal negro brillo		aluminio / blanco polar		aluminio / negro		acero / blanco polar		acero / negro	
													
		Ref.	Precio	Ref.	Precio	Ref.	Precio	Ref.	Precio	Ref.	Precio	Ref.	Precio
<b>Interrup- tor</b>	Mecanismo	3031	4,91	3031	4,91	3031	4,91	3031	4,91	3031	4,91	3031	4,91
	Tecla	1620 20 89	2,99	1620 20 45	6,41	1620 20 89	2,99	1620 20 45	6,41	1620 20 89	2,99	1620 20 45	6,41
	Marco 1 elem.	1011 26 09	<b>38,44</b>	1011 26 16	<b>38,44</b>	1011 26 74	<b>57,62</b>	1011 26 74	<b>57,62</b>	1011 26 14	<b>68,94</b>	1011 26 14	<b>68,94</b>
			<b>46,34</b>		<b>49,76</b>		<b>65,52</b>		<b>65,52</b>		<b>68,94</b>		<b>68,94</b>
<b>Conmu- tador</b>	Mecanismo	3036	5,61	3036	5,61	3036	5,61	3036	5,61	3036	5,61	3036	5,61
	Tecla	1620 20 89	2,99	1620 20 45	6,41	1620 20 89	2,99	1620 20 45	6,41	1620 20 89	2,99	1620 20 45	6,41
	Marco 1 elem.	1011 26 09	<b>38,44</b>	1011 26 16	<b>38,44</b>	1011 26 74	<b>57,62</b>	1011 26 74	<b>57,62</b>	1011 26 14	<b>69,64</b>	1011 26 14	<b>69,64</b>
			<b>47,04</b>		<b>50,46</b>		<b>66,22</b>		<b>66,22</b>		<b>69,64</b>		<b>69,64</b>
<b>Cruza- miento</b>	Mecanismo	3037	11,63	3037	11,63	3037	11,63	3037	11,63	3037	11,63	3037	11,63
	Tecla	1620 20 89	2,99	1620 20 45	6,41	1620 20 89	2,99	1620 20 45	6,41	1620 20 89	2,99	1620 20 45	6,41
	Marco 1 elem.	1011 26 09	<b>38,44</b>	1011 26 16	<b>38,44</b>	1011 26 74	<b>57,62</b>	1011 26 74	<b>57,62</b>	1011 26 14	<b>75,66</b>	1011 26 14	<b>75,66</b>
			<b>53,06</b>		<b>56,48</b>		<b>72,24</b>		<b>72,24</b>		<b>75,66</b>		<b>75,66</b>
<b>Toma SCHUKO*</b>	Mecanismo	7341232089	10,28	7141 34	5,82	7341232089	10,28	7141 34	5,82	7341232089	10,28	7141 34	5,82
	Tapa			1719 20 45	5,60			1719 20 45	5,60			1719 20 45	5,60
	Marco 1 elem.	1011 26 09	<b>38,44</b>	1011 26 16	<b>38,44</b>	1011 26 74	<b>57,62</b>	1011 26 74	<b>57,62</b>	1011 26 14	<b>69,04</b>	1011 26 14	<b>69,04</b>
			<b>48,72</b>		<b>49,86</b>		<b>67,90</b>		<b>69,04</b>		<b>69,04</b>		<b>69,04</b>
<b>Pulsador</b>	Mecanismo	5031	6,02	5031	6,02	5031	6,02	5031	6,02	5031	6,02	5031	6,02
	Tecla	1620 20 89	2,99	1620 20 45	6,41	1620 20 89	2,99	1620 20 45	6,41	1620 20 89	2,99	1620 20 45	6,41
	Marco 1 elem.	1011 26 09	<b>38,44</b>	1011 26 16	<b>38,44</b>	1011 26 74	<b>57,62</b>	1011 26 74	<b>57,62</b>	1011 26 14	<b>66,63</b>	1011 26 14	<b>66,63</b>
			<b>47,45</b>		<b>50,87</b>		<b>66,63</b>		<b>70,05</b>		<b>66,63</b>		<b>70,05</b>
<b>Doble interrup- tor</b>	Mecanismo	3035	7,36	3035	7,36	3035	7,36	3035	7,36	3035	7,36	3035	7,36
	Tecla	1623 20 89	4,23	1623 20 45	9,12	1623 20 89	4,23	1623 20 45	9,12	1623 20 89	4,23	1623 20 45	9,12
	Marco 1 elem.	1011 26 09	<b>38,44</b>	1011 26 16	<b>38,44</b>	1011 26 74	<b>57,62</b>	1011 26 74	<b>57,62</b>	1011 26 14	<b>69,21</b>	1011 26 14	<b>69,21</b>
			<b>50,03</b>		<b>54,92</b>		<b>69,21</b>		<b>74,10</b>		<b>69,21</b>		<b>74,10</b>
<b>Doble conmu- tador</b>	Mecanismo	3038 08	18,30	3038 08	18,30	3038 08	18,30	3038 08	18,30	3038 08	18,30	3038 08	18,30
	Tecla	1623 20 89	4,23	1623 20 45	9,12	1623 20 89	4,23	1623 20 45	9,12	1623 20 89	4,23	1623 20 45	9,12
	Marco 1 elem.	1011 26 09	<b>38,44</b>	1011 26 16	<b>38,44</b>	1011 26 74	<b>57,62</b>	1011 26 74	<b>57,62</b>	1011 26 14	<b>85,04</b>	1011 26 14	<b>85,04</b>
			<b>60,97</b>		<b>65,86</b>		<b>80,15</b>		<b>85,04</b>		<b>80,15</b>		<b>85,04</b>
<b>Doble interrup- tor persianas</b>	Mecanismo	3035 20	16,94	3035 20	16,94	3035 20	16,94	3035 20	16,94	3035 20	16,94	3035 20	16,94
	Tecla doble c/flecha	1625 20 89	5,25	1625 20 45	11,29	1625 20 89	5,25	1625 20 45	11,29	1625 20 89	5,25	1625 20 45	11,29
	Marco 1 elem.	1011 26 09	<b>38,44</b>	1011 26 16	<b>38,44</b>	1011 26 74	<b>57,62</b>	1011 26 74	<b>57,62</b>	1011 26 14	<b>79,81</b>	1011 26 14	<b>79,81</b>
			<b>60,63</b>		<b>66,67</b>		<b>79,81</b>		<b>85,85</b>		<b>79,81</b>		<b>85,85</b>
<b>Doble pulsador persianas</b>	Mecanismo	5035 20	16,11	5035 20	16,11	5035 20	16,11	5035 20	16,11	5035 20	16,11	5035 20	16,11
	Tecla doble c/flecha	1625 20 89	5,25	1625 20 45	11,29	1625 20 89	5,25	1625 20 45	11,29	1625 20 89	5,25	1625 20 45	11,29
	Marco 1 elem.	1011 26 09	<b>38,44</b>	1011 26 16	<b>38,44</b>	1011 26 74	<b>57,62</b>	1011 26 74	<b>57,62</b>	1011 26 14	<b>78,98</b>	1011 26 14	<b>78,98</b>
			<b>59,80</b>		<b>65,84</b>		<b>78,98</b>		<b>85,02</b>		<b>78,98</b>		<b>85,02</b>
<b>Toma teléfono cat. 3</b>	Mecanismo	4538	11,61	4538	11,61	4538	11,61	4538	11,61	4538	11,61	4538	11,61
	Tapa	1407 20 89	6,71	1407 20 45	7,25	1407 20 89	6,71	1407 20 45	7,25	1407 20 89	6,71	1407 20 45	7,25
	Marco 1 elem.	1011 26 09	<b>38,44</b>	1011 26 16	<b>38,44</b>	1011 26 74	<b>57,62</b>	1011 26 74	<b>57,62</b>	1011 26 14	<b>75,94</b>	1011 26 14	<b>75,94</b>
			<b>56,76</b>		<b>57,30</b>		<b>75,94</b>		<b>76,48</b>		<b>75,94</b>		<b>76,48</b>
<b>Toma simple RJ45 cat. 6e</b>	Mecanismo	4554 01	28,10	4554 01	28,10	4554 01	28,10	4554 01	28,10	4554 01	28,10	4554 01	28,10
	Tapa	1407 20 89	6,71	1407 20 45	7,25	1407 20 89	6,71	1407 20 45	7,25	1407 20 89	6,71	1407 20 45	7,25
	Marco 1 elem.	1011 26 09	<b>38,44</b>	1011 26 16	<b>38,44</b>	1011 26 74	<b>57,62</b>	1011 26 74	<b>57,62</b>	1011 26 14	<b>92,97</b>	1011 26 14	<b>92,97</b>
			<b>73,25</b>		<b>73,79</b>		<b>92,43</b>		<b>92,97</b>		<b>92,43</b>		<b>92,97</b>
<b>Toma doble RJ45 cat. 6e</b>	Mecanismo	4555 01	36,15	4555 01	36,15	4555 01	36,15	4555 01	36,15	4555 01	36,15	4555 01	36,15
	Tapa	1409 20 89	6,71	1409 20 45	7,25	1409 20 89	6,71	1409 20 45	7,25	1409 20 89	6,71	1409 20 45	7,25
	Marco 1 elem.	1011 26 09	<b>38,44</b>	1011 26 16	<b>38,44</b>	1011 26 74	<b>57,62</b>	1011 26 74	<b>57,62</b>	1011 26 14	<b>101,02</b>	1011 26 14	<b>101,02</b>
			<b>81,30</b>		<b>81,84</b>		<b>100,48</b>		<b>101,02</b>		<b>100,48</b>		<b>101,02</b>
<b>Toma TV</b>	Mecanismo	4522 10	20,48	4522 10	20,48	4522 10	20,48	4522 10	20,48	4522 10	20,48	4522 10	20,48
	Tapa	1203 20 89	6,71	1203 20 45	7,25	1203 20 89	6,71	1203 20 45	7,25	1203 20 89	6,71	1203 20 45	7,25
	Marco 1 elem.	1011 26 09	<b>38,44</b>	1011 26 16	<b>38,44</b>	1011 26 74	<b>57,62</b>	1011 26 74	<b>57,62</b>	1011 26 14	<b>85,35</b>	1011 26 14	<b>85,35</b>
			<b>65,63</b>		<b>66,17</b>		<b>84,81</b>		<b>85,35</b>		<b>84,81</b>		<b>85,35</b>
<b>Salida de hilos</b>	Mecanismo	4470	13,40	4470	13,40	4470	13,40	4470	13,40	4470	13,40	4470	13,40
	Tapa	1019 20 89	6,71	1019 20 45	7,25	1019 20 89	6,71	1019 20 45	7,25	1019 20 89	6,71	1019 20 45	7,25
	Marco 1 elem.	1011 26 09	<b>38,44</b>	1011 26 16	<b>38,44</b>	1011 26 74	<b>57,62</b>	1011 26 74	<b>57,62</b>	1011 26 14	<b>77,73</b>	1011 26 14	<b>77,73</b>
			<b>58,55</b>		<b>59,09</b>		<b>77,73</b>		<b>78,27</b>		<b>77,73</b>		<b>78,27</b>
<b>Tapa ciega</b>	Mec. con tapa	1009 20 89	10,62	1009 20 45	11,31	1009 20 89	10,62	1009 20 45	11,31	1009 20 89	10,62	1009 20 45	11,31
	Marco 1 elem.	1011 26 09	<b>38,44</b>	1011 26 16	<b>38,44</b>	1011 26 74	<b>57,62</b>	1011 26 74	<b>57,62</b>	1011 26 14	<b>68,24</b>	1011 26 14	<b>68,24</b>
				<b>49,06</b>		<b>49,75</b>		<b>68,24</b>		<b>68,93</b>		<b>68,24</b>	
<b>Marco</b>	2 elementos	1012 26 09	67,84	1012 26 16	67,84	1012 26 74	101,78	1012 26 74	101,78	1012 26 14	101,78	1012 26 14	101,78
	3 elementos	1013 26 09	89,35	1013 26 16	89,35	1013 26 74	170,15	1013 26 74	170,15	1013 26 14	170,15	1013 26 14	170,15
	4 elementos	1014 26 09	122,19	1014 26 16	122,19	1014 26 74	232,77	1014 26 74	232,77	1014 26 14	232,77	1014 26 14	232,77





Cajas de empotrar para cada función:  
Instalaciones en muro: caja roja+blanca  
Instalaciones en yeso: caja blanca

		blanco polar, brillo	negro brillo	aluminio / blanco polar, brillo	aluminio / negro, brillo	acero / blanco polar, brillo	acero negro, brillo						
													
		Ref.	Precio	Ref.	Precio	Ref.	Precio	Ref.	Precio	Ref.	Precio	Ref.	Precio
<b>Conmutador</b>	Mecanismo	3876 03	18,80	3876 03	18,80	3876 03	18,80	3876 03	18,80	3876 03	18,80	3876 03	18,80
	Tapa central con manecilla	1001 20 89 00	20,31 <b>39,11</b>	1001 20 45 00	20,31 <b>39,11</b>	1001 20 74 00	55,27 <b>74,07</b>	1001 20 84 00	55,27 <b>74,07</b>	1001 20 14 00	67,56 <b>86,36</b>	1001 20 04 00	67,56 <b>86,36</b>
<b>Cruza-fuente</b>	Mecanismo	3877 03	36,84	3877 03	36,84	3877 03	36,84	3877 03	36,84	3877 03	36,84	3877 03	36,84
	Tapa central con manecilla	1001 20 89 00	20,31 <b>57,15</b>	1001 20 45 00	20,31 <b>57,15</b>	1001 20 74 00	55,27 <b>92,11</b>	1001 20 84 00	55,27 <b>92,11</b>	1001 20 14 00	67,56 <b>104,40</b>	1001 20 04 00	67,56 <b>104,40</b>
<b>Toma SCHUKO*</b>	Mec. c/ tapa	4755 20 89	19,78	4755 20 45	19,78	4755 20 89	19,78	4755 20 45	19,78	4755 20 89	19,78	4755 20 45	19,78
	Marco 1 elemento	1011 20 89	6,71 <b>26,49</b>	1011 20 45	6,71 <b>26,49</b>	1011 20 74	42,99 <b>62,77</b>	1011 20 84	42,99 <b>62,77</b>	1011 20 14	55,27 <b>75,05</b>	1011 20 04	55,27 <b>75,05</b>
<b>Pulsador</b>	Mecanismo	3846 03	24,44	3846 03	24,44	3846 03	24,44	3846 03	24,44	3846 03	24,44	3846 03	24,44
	Tapa central con manecilla	1001 20 89 00	20,31 <b>44,75</b>	1001 20 45 00	20,31 <b>44,75</b>	1001 20 74 00	55,27 <b>79,71</b>	1001 20 84 00	55,27 <b>79,71</b>	1001 20 14 00	67,56 <b>92,00</b>	1001 20 04 00	67,56 <b>92,00</b>
<b>Doble interruptor</b>	Mecanismo	3875 03	23,06	3875 03	23,06	3875 03	23,06	3875 03	23,06	3875 03	23,06	3875 03	23,06
	Tapa central con manecilla	1001 20 89	20,31 <b>43,37</b>	1001 20 45 00	20,31 <b>43,37</b>	1001 20 74 00	55,27 <b>78,33</b>	1001 20 84 00	55,27 <b>78,33</b>	1001 20 14 00	67,56 <b>90,62</b>	1001 20 04 00	67,56 <b>90,62</b>
<b>Toma teléfono cat. 3</b>	Mecanismo	4538	11,61	4538	11,61	4538	11,61	4538	11,61	4538	11,61	4538	11,61
	Tapa	1407 20 89	6,71	1407 20 45	7,25	1407 20 89	6,71	1407 20 45	7,25	1407 20 89	6,71	1407 20 45	7,25
	Marco 1 elem.	1011 20 89	6,71 <b>25,03</b>	1011 20 45	6,71 <b>25,57</b>	1011 20 74	42,99 <b>61,31</b>	1011 20 84	42,99 <b>61,85</b>	1011 20 14	55,27 <b>73,59</b>	1011 20 04	55,27 <b>74,13</b>
<b>Toma simple RJ45 cat. 6e</b>	Mecanismo	4554 01	28,10	4554 01	28,10	4554 01	28,10	4554 01	28,10	4554 01	28,10	4554 01	28,10
	Tapa	1407 20 89	6,71	1407 20 45	7,25	1407 20 89	6,71	1407 20 45	7,25	1407 20 89	6,71	1407 20 45	7,25
	Marco 1 elem.	1011 20 89	6,71 <b>41,52</b>	1011 20 45	6,71 <b>42,06</b>	1011 20 74	42,99 <b>77,80</b>	1011 20 84	42,99 <b>78,34</b>	1011 20 14	55,27 <b>90,08</b>	1011 20 04	55,27 <b>90,62</b>
<b>Toma doble RJ45 cat. 6e</b>	Mecanismo	4555 01	36,15	4555 01	36,15	4555 01	36,15	4555 01	36,15	4555 01	36,15	4555 01	36,15
	Tapa	1409 20 89	6,71	1409 20 45	7,25	1409 20 89	6,71	1409 20 45	7,25	1409 20 89	6,71	1409 20 45	7,25
	Marco 1 elem.	1011 20 89	6,71 <b>49,57</b>	1011 20 45	6,71 <b>50,11</b>	1011 20 74	42,99 <b>85,85</b>	1011 20 84	42,99 <b>86,39</b>	1011 20 14	55,27 <b>98,13</b>	1011 20 04	55,27 <b>98,67</b>
<b>Toma TV</b>	Mecanismo	4522 10	20,48	4522 10	20,48	4522 10	20,48	4522 10	20,48	4522 10	20,48	4522 10	20,48
	Tapa	1203 20 89	6,71	1203 20 45	7,25	1203 20 89	6,71	1203 20 45	7,25	1203 20 89	6,71	1203 20 45	7,25
	Marco 1 elem.	1011 20 89	6,71 <b>33,90</b>	1011 20 45	6,71 <b>34,44</b>	1011 20 74	42,99 <b>70,18</b>	1011 20 84	42,99 <b>70,72</b>	1011 20 14	55,27 <b>82,46</b>	1011 20 04	55,27 <b>83,00</b>
<b>Salida de hilos</b>	Mecanismo	4468	11,06	4468	11,06	4468	11,06	4468	11,06	4468	11,06	4468	11,06
	Tapa	1019 20 89	6,71	1019 20 45	7,25	1019 20 89	6,71	1019 20 45	7,25	1019 20 89	6,71	1019 20 45	7,25
	Marco 1 elem.	1011 20 89	6,71 <b>24,48</b>	1011 20 45	6,71 <b>25,02</b>	1011 20 74	42,99 <b>60,76</b>	1011 20 84	42,99 <b>61,30</b>	1011 20 14	55,27 <b>73,04</b>	1011 20 04	55,27 <b>73,58</b>
<b>Tapa ciega</b>	Mec. con tapa	1009 20 79	21,56	1009 20 35	21,56	1009 20 79	21,56	1009 20 35	21,56	1009 20 79	21,56	1009 20 35	21,56
	Marco 1 elem.	1011 20 89	6,71 <b>28,27</b>	1011 20 45	6,71 <b>28,27</b>	1011 20 74	42,99 <b>64,55</b>	1011 20 84	42,99 <b>64,55</b>	1011 20 14	55,27 <b>76,83</b>	1011 20 04	55,27 <b>76,83</b>
<b>Marco</b>	2 elementos	1012 20 89	18,94	1012 20 45	18,94	1012 20 74	72,97	1012 20 84	72,97	1012 20 14	134,51	1012 20 04	134,51
	3 elementos	1013 20 89	28,98	1013 20 45	28,98	1013 20 74	105,84	1013 20 84	105,84	1013 20 14	195,12	1013 20 04	195,12

Nota: verificar referencias de esta serie que pueden instalarse en marcos  
Instalación en caja de empotrar redonda

		cristal blanco polar		cristal negro	
					
		Ref.	Precio	Ref.	Precio
<b>Conmutador</b>	Mecanismo	3876 03	18,80	3876 03	18,80
	Tecla central con manecilla	1001 20 83 00	41,58 <b>60,38</b>	1001 20 55 00	41,58 <b>60,38</b>
<b>Cruzamiento</b>	Mecanismo	3877 03	36,84	3877 03	36,84
	Tecla central con manecilla	1001 20 83 00	41,58 <b>78,42</b>	1001 20 55 00	41,58 <b>78,42</b>
<b>Toma SCHUKO*</b>	Mec. c/ tapa	4755 20 89	19,78	4755 20 45	19,78
	Marco 1 elemento	1011 20 09	36,85 <b>56,63</b>	1011 20 16	36,85 <b>56,63</b>
<b>Pulsador</b>	Mecanismo	3846 03	24,44	3846 03	24,44
	Tecla central con manecilla	1001 20 83 00	41,58 <b>66,02</b>	1001 20 55 00	41,58 <b>66,02</b>
<b>Doble interruptor</b>	Mecanismo	3875 03	23,06	3875 03	23,06
	Tecla central con manecilla	1001 20 83 00	41,58 <b>64,64</b>	1001 20 55 00	41,58 <b>64,64</b>
<b>Toma teléfono cat. 3</b>	Mecanismo	4538	11,61	4538	11,61
	Tapa	1407 20 89	6,71	1407 20 45	7,25
	Marco 1 elemento	1011 20 09	36,85	1011 20 16	36,85
			<b>55,17</b>		<b>55,71</b>
<b>Toma simple RJ45 cat. 6e</b>	Mecanismo	4554 01	28,10	4554 01	28,10
	Tapa	1407 20 89	6,71	1407 20 45	7,25
	Marco 1 elemento	1011 20 09	36,85	1011 20 16	36,85
			<b>71,66</b>		<b>72,20</b>
<b>Toma doble RJ45 cat. 6e</b>	Mecanismo	4555 01	36,15	4555 01	36,15
	Tapa	1409 20 89	6,71	1409 20 45	7,25
	Marco 1 elemento	1011 20 09	36,85	1011 20 16	36,85
			<b>79,71</b>		<b>80,25</b>
<b>Toma TV</b>	Mecanismo	4522 10	20,48	4522 10	20,48
	Tapa	1203 20 89	6,71	1203 20 45	7,25
	Marco 1 elemento	1011 20 09	36,85	1011 20 16	36,85
			<b>64,04</b>		<b>64,58</b>
<b>Salida de hilos</b>	Mecanismo	4468	11,06	4468	11,06
	Tapa	1019 20 89	6,71	1019 20 45	7,25
	Marco 1 elemento	1011 20 09	36,85	1011 20 16	36,85
			<b>54,62</b>		<b>55,16</b>
<b>Tapa ciega</b>	Mecanismo con tapa	1009 20 79	21,56	1009 20 35	21,56
	Marco 1 elemento	1011 20 09	36,85 <b>58,41</b>	1011 20 16	36,85 <b>58,41</b>
<b>Marco</b>	2 elementos	1012 20 09	72,97	1012 20 16	72,97
	3 elementos	1013 20 09	<b>105,84</b>	1013 20 16	<b>105,84</b>

Nota: verificar referencias de esta serie que pueden instalarse en marcos  
Instalación en caja de empotrar redonda

		blanco polar		negro		blanco polar Porzellan made by Rosenthal		negro Porzellan made by Rosenthal	
									
		Ref.	Precio	Ref.	Precio	Ref.	Precio	Ref.	Precio
<b>Interruptor / conmutador</b>	Mecanismo	3876 03	18,80	3876 03	18,80	3876 03	18,80	3876 03	18,80
	Tapa central con manecilla	1647	12,52	1647 01	12,52	1647 69 00	46,20	1647 65 00	77,25
	Marco 1 elemento	1381 09	4,26	1381 01	4,26	1381 69	47,24	1381 65	47,24
			<b>35,58</b>		<b>35,58</b>		<b>112,24</b>		<b>143,29</b>
<b>Cruzamiento</b>	Mecanismo	3877 03	36,84	3877 03	36,84	3877 03	36,84	3877 03	36,84
	Tapa central con manecilla	1647	12,52	1647 01	12,52	1647 69 00	46,20	1647 65 00	77,25
	Marco 1 elemento	1381 09	4,26	1381 01	4,26	1381 69	47,24	1381 65	47,24
			<b>53,62</b>		<b>53,62</b>		<b>130,28</b>		<b>161,33</b>
<b>Toma SCHUKO*</b>	Mecanismo con tapa	4755	32,96	4755 01	32,96				
	Marco 1 elemento	1381 09	4,26	1381 01	4,26				
			<b>37,22</b>		<b>37,22</b>				
<b>Pulsador</b>	Mecanismo	3846 03	24,44	3846 03	24,44	3846 03	24,44	3846 03	24,44
	Tecla central con manecilla	1647	12,52	1647 01	12,52	1647 69 00	46,20	1647 65 00	77,25
	Marco 1 elemento	1381 09	4,26	1381 01	4,26	1381 69	47,24	1381 65	47,24
			<b>41,22</b>		<b>41,22</b>		<b>117,88</b>		<b>148,93</b>
<b>Pulsador botón</b>	Mecanismo	5104	26,44	5104 01	26,44				
	Pulsador	1225	9,52	1225 01	9,52				
	Marco 1 elemento	1381 09	4,26	1381 01	4,26				
			<b>40,22</b>		<b>40,22</b>				
<b>Doble interruptor</b>	Mecanismo	3875 03	23,06	3875 03	23,06	3875 03	23,06	3875 03	23,06
	Tecla	1647	12,52	1647 01	12,52	1647 69	46,20	1647 65	77,25
	Marco 1 elemento	1381 09	4,26	1381 01	4,26	1381 69	47,24	1381 65	47,24
			<b>39,84</b>		<b>39,84</b>		<b>116,50</b>		<b>147,55</b>
<b>Toma teléfono cat. 3</b>	Mecanismo	4538	11,61	4538	11,61				
	Tapa	1407	16,29	1407 01	16,29				
	Marco 1 elemento	1381 09	4,26	1381 01	4,26				
			<b>32,16</b>		<b>32,16</b>				
<b>Toma simple RJ45 cat. 6e</b>	Mecanismo	4554 01	28,10	4554 01	28,10				
	Tapa	1407	16,29	1407 01	16,29				
	Marco 1 elemento	1381 09	4,26	1381 01	4,26				
			<b>48,65</b>		<b>48,65</b>				
<b>Toma doble RJ45 cat. 6e</b>	Mecanismo	4555 01	36,15	4555 01	36,15				
	Tapa	1409	25,18	1409 01	25,18				
	Marco 1 elemento	1381 09	4,26	1381 01	4,26				
			<b>65,59</b>		<b>65,59</b>				
<b>Toma TV</b>	Mecanismo	4522 10	20,48	4522 10	20,48				
	Tapa	1064 20	25,18	1064 21	25,18				
	Marco 1 elemento	1381 09	4,26	1381 01	4,26				
			<b>49,92</b>		<b>49,92</b>				
<b>Salida de hilos</b>	Mecanismo	4468	11,06	4468	11,06				
	Tapa	1037	9,87	1037 01	9,87				
	Marco 1 elemento	1381 09	3,61	1381 01	3,61				
			<b>24,54</b>		<b>24,54</b>				
<b>Tapa ciega</b>	Mecanismo con tapa	1009 20	29,07	1009 21	29,07				
	Marco 1 elemento	1381 09	3,61	1381 01	3,61				
			<b>32,68</b>		<b>32,68</b>				
<b>Marco</b>	2 elementos	1381 29	10,18	1381 21	10,18				
	3 elementos	1381 39	15,38	1381 31	15,38				
	Intermedio	1381 59	16,76	1381 51	16,76				
	Final	1381 49	14,32	1381 41	14,32				

Instalación en caja de empotrar redonda

blanco polar

negro



		Ref.	Precio	Ref.	Precio
<b>Interruptor / Conmutador</b>	Mecanismo	3876 03	18,80	3876 03	18,80
	Tapa central con manecilla	1647	12,52	1647 01	12,52
	Marco 1 elemento	1091	34,46	1091	34,46
			<b>65,78</b>		<b>65,78</b>
<b>Cruzamiento</b>	Mecanismo	3877 03	36,84	3877 03	36,84
	Tapa central con manecilla	1647	12,52	1647 01	12,52
	Marco 1 elemento	1091	34,46	1091	34,46
			<b>83,82</b>		<b>83,82</b>
<b>Toma SCHUKO*</b>	Mecanismo con tapa	4755	32,96	4755 01	32,96
	Marco 1 elemento	1091	34,46	1091	34,46
			<b>67,42</b>		<b>67,42</b>
<b>Pulsador</b>	Mecanismo	3846 03	24,44	3846 03	24,44
	Tecla central con manecilla	1647	12,52	1647 01	12,52
	Marco 1 elemento	1091	34,46	1091	34,46
			<b>71,42</b>		<b>71,42</b>
<b>Pulsador botón</b>	Mecanismo	5104	26,44	5104 01	26,44
	Pulsador	1225	9,52	1225 01	9,52
	Marco 1 elemento	1091	34,46	1091	34,46
			<b>70,42</b>		<b>70,42</b>
<b>Doble interruptor</b>	Mecanismo	3875 03	23,06	3875 03	23,06
	Tecla	1647	12,52	1647 01	12,52
	Marco 1 elemento	1091	34,46	1091	34,46
			<b>70,04</b>		<b>70,04</b>
<b>Toma teléfono cat. 3</b>	Mecanismo	4538	11,61	4538	11,61
	Tapa	1407	16,29	1407 01	16,29
	Marco 1 elemento	1091	34,46	1091	34,46
			<b>62,36</b>		<b>62,36</b>
<b>Toma simple RJ45 cat. 6e</b>	Mecanismo	4554 01	28,10	4554 01	28,10
	Tapa	1407	16,29	1407 01	16,29
	Marco 1 elemento	1091	34,46	1091	34,46
			<b>78,85</b>		<b>78,85</b>
<b>Toma doble RJ45 cat. 6e</b>	Mecanismo	4555 01	36,15	4555 01	36,15
	Tapa	1409	25,18	1409 01	25,18
	Marco 1 elemento	1091	34,46	1091	34,46
			<b>95,79</b>		<b>95,79</b>
<b>Toma TV</b>	Mecanismo	4522 10	20,48	4522 10	20,48
	Tapa	1064 20	25,18	1064 21	25,18
	Marco 1 elemento	1091	34,46	1091	34,46
			<b>80,12</b>		<b>80,12</b>
<b>Salida de hilos</b>	Mecanismo	4468	11,06	4468	11,06
	Tapa	1037	11,65	1037 01	11,65
	Marco 1 elemento	1091	34,46	1091	34,46
			<b>57,17</b>		<b>57,17</b>
<b>Tapa ciega</b>	Mecanismo con tapa	1009 20	34,33	1009 21	34,33
	Marco 1 elemento	1091	34,46	1091	34,46
			<b>68,79</b>		<b>68,79</b>
<b>Marco</b>	2 elementos	1102	62,14	1102	62,14
	Intermedio	1093 00	43,98	1093 00	43,98
	Final	1092 00	40,59	1092 00	40,59

Instalación en caja de empotrar redonda

# Estándar de calidad lumina

La gama lumina disponible en blanco polar, plata y negro, es la respuesta a las necesidades del mercado actual, que exige soluciones más económicas donde la relación coste/beneficio es un factor decisivo.



# lumina

pág.

---

presentación lumina soul y lumina intense	42
concepto modular	46
marcos, cajas superficie	50
mecanismos	53
tomas telefonía, datos	56
tomas RTV, SAT	57
reguladores, otros...	58

---



# lumina soul.

## La base perfecta.



lumina soul es la base sólida de una instalación que cumple con los requisitos de hoy y supera los del mañana. Diseñada y fabricada por expertos que conocen el desarrollo global desde la instalación hasta la operativa, los interruptores lumina y las tomas son ya parte natural del interior de cualquier edificio.





# lumina intense. Preparados para más.



**lumina intense ofrece tres atractivos colores y un diseño de marco completamente nuevo. Para nuevas posibilidades. Y para cualquier entorno.**



## 01 Mecanismo y tecla

Robusto, preciso y seguro:  
el mecanismo tiene bastidor  
metálico y garras.

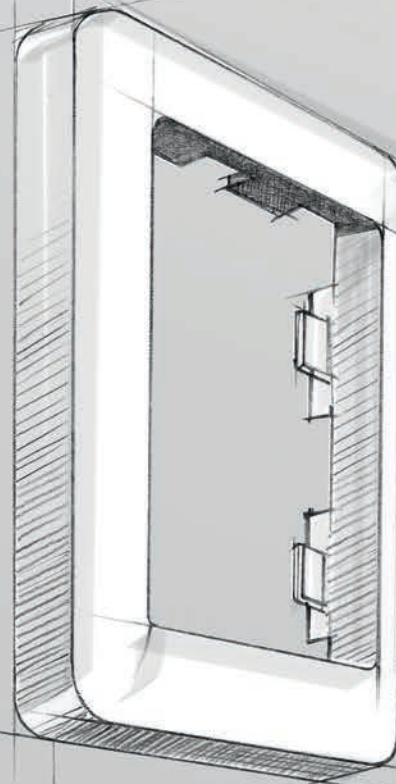
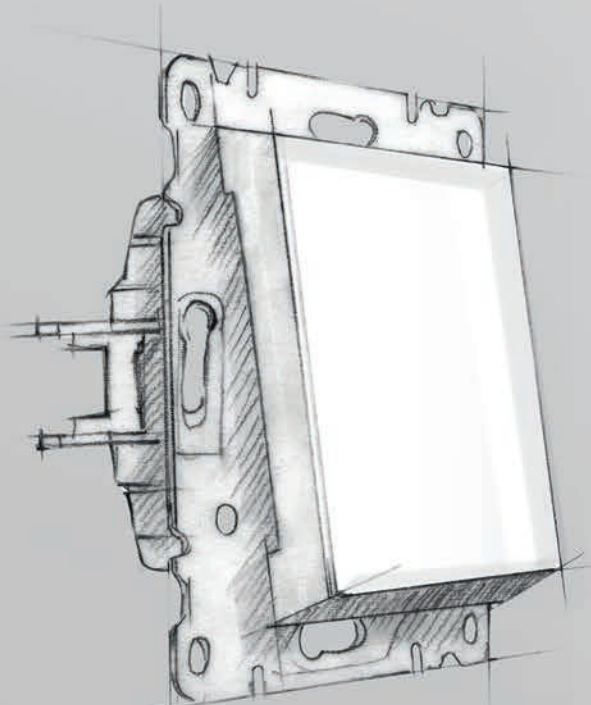

*lumina  
Soul*

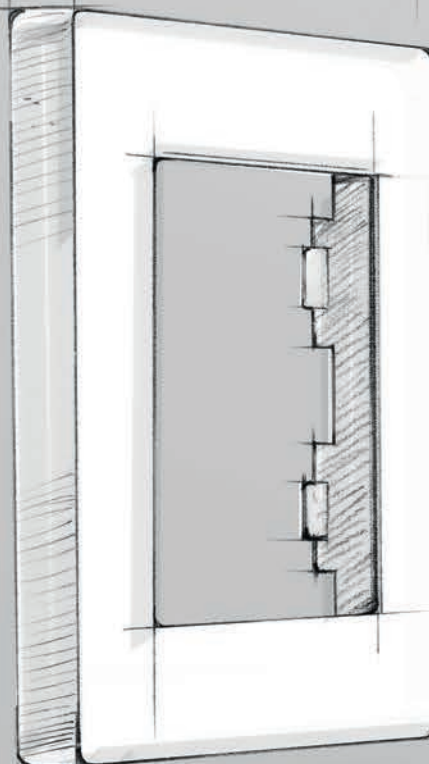

*lumina  
Intense*

## 02 Marco en dos acabados

Un marco preciso que encaja  
exactamente. Diseñado con una  
pequeña distancia a la pared  
que le da una apariencia incluso  
más atractiva.

# Escoge, encaja, y... clic!

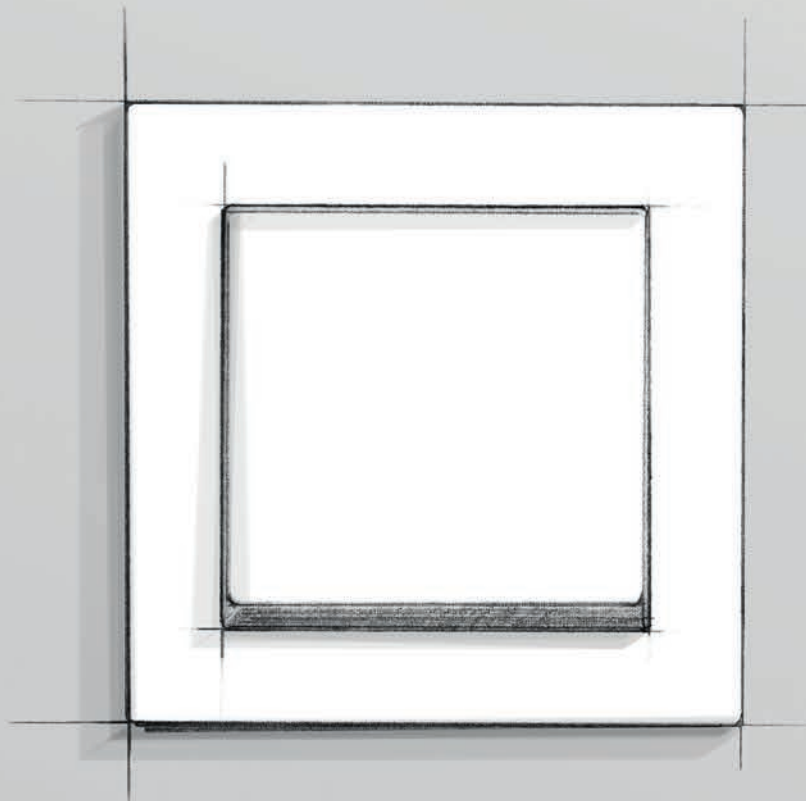

**La idea principal de lumina es un diseño modular simple y funcional. Un mismo mecanismo que puede utilizarse con las distintas series: soul e intense. Escoge la combinación que prefieras: cualquier acabado lumina armonizará perfectamente no solo con la pared, sino también con el diseño interior.**

**¿Cuál es tu lumina favorita?.**

# lumina estándar de calidad

lumina es la solución económica y con la mejor calidad para tus proyectos. Amplia oferta compuesta por interruptores simples, dobles, triples, con indicador, reguladores de luz rotativos, tomas Schuko...

Su concepto modular, permite con tan sólo 2 referencias obtener un producto completo. El uso de marcos múltiples permite el montaje de hasta 5 elementos.



## Ventajas:

---

- 3 colores disponibles: blanco polar brillo, plata mate y negro mate.
  - Marco de hasta 5 elementos
  - Garras en todos los mecanismos
  - Embalaje individual
- 

## Características técnicas:

---

- |  |                               |
|--|-------------------------------|
| - 2 referencias para completar el producto | - Mecanismo con tecla y marco |
| - Bastidor:                                | - Metálico                    |
| - Productos certificados:                  | - VDE y AENOR                 |
-

# Más ventajas



01

Diseño moderno y estético. Ideal para su uso en cualquier lugar.

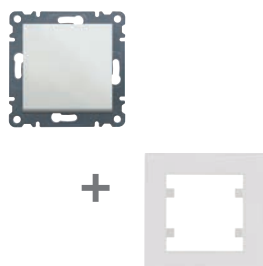

02

Montaje rápido y fácil. Con solo 2 referencias se monta el producto componiéndolo según las necesidades requeridas. Mecanismo con tecla y marco.

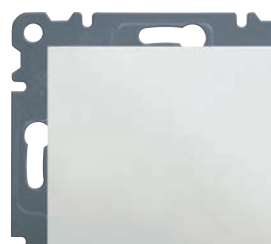

03

El bastidor metálico garantiza un montaje seguro y sin deteriorarse sobre superficies irregulares.



04

Embalaje individual de cada elemento de la serie lumina que protege el producto durante el transporte y el montaje en el lugar de la obra.



05

Perfecta fijación ya que todos los mecanismos incorporan garras.



06

Productos certificados VDE y AENOR.

## Marcos lumina soul



WL5010

### Marcos lumina soul, blanco polar

Descripción	Referencia	Emb.	Precio (€)
<b>1 elemento</b>	WL5010	12	<b>1,16</b>

horizontal:

<b>2 elementos</b>	WL5220	25	<b>2,09</b>
<b>3 elementos</b>	WL5230	20	<b>3,36</b>
<b>4 elementos</b>	WL5240	25	<b>5,98</b>
<b>5 elementos</b>	WL5250	6	<b>8,24</b>

vertical:

<b>2 elementos</b>	WL5120	25	<b>2,09</b>
<b>3 elementos</b>	WL5130	20	<b>3,36</b>
<b>4 elementos</b>	WL5140	25	<b>5,98</b>
<b>5 elementos</b>	WL5150	6	<b>8,24</b>

## Cajas de superficie, lumina soul

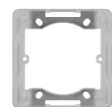

WL5410

### Caja principal

Descripción	Referencia	Emb.	Precio (€)
<b>Blanco polar</b>	WL5410	12	<b>6,21</b>



WL5420

### Caja módulo extensión

Descripción	Referencia	Emb.	Precio (€)
<b>Blanco polar</b>	WL5420	12	<b>4,42</b>

- tornillos y tacos incluidos

**Nota:** En instalaciones en paredes de tabique hueco, se recomienda dejar la caja de empotrar enrasada con la pared con el fin de que la instalación de nuestras series de mecanismos se realice de la manera que se han diseñado. Recomendamos el uso de una sierra de corona con avellanador.

## Marcos lumina intense



WL5510

### Marcos lumina intense, blanco polar

Descripción	Referencia	Emb.	Precio (€)
<b>1 elemento</b>	WL5510	12	<b>1,25</b>

horizontal:

<b>2 elementos</b>	WL5720	25	<b>2,31</b>
<b>3 elementos</b>	WL5730	20	<b>3,58</b>
<b>4 elementos</b>	WL5740	25	<b>6,35</b>
<b>5 elementos</b>	WL5750	6	<b>8,88</b>

vertical:

<b>2 elementos</b>	WL5620	25	<b>2,31</b>
<b>3 elementos</b>	WL5630	20	<b>3,58</b>
<b>4 elementos</b>	WL5640	25	<b>6,35</b>
<b>5 elementos</b>	WL5650	6	<b>8,88</b>



WL5512

### Marcos lumina intense, plata

Descripción	Referencia	Emb.	Precio (€)
<b>1 elemento</b>	WL5512	12	<b>3,42</b>

horizontal:

<b>2 elementos</b>	WL5722	25	<b>6,26</b>
<b>3 elementos</b>	WL5732	20	<b>9,71</b>
<b>4 elementos</b>	WL5742	25	<b>17,24</b>
<b>5 elementos</b>	WL5752	6	<b>24,09</b>

vertical:

<b>2 elementos</b>	WL5622	25	<b>6,26</b>
<b>3 elementos</b>	WL5632	20	<b>9,71</b>
<b>4 elementos</b>	WL5642	25	<b>17,24</b>
<b>5 elementos</b>	WL5652	6	<b>24,09</b>



WL5513

### Marcos lumina intense, negro

Descripción	Referencia	Emb.	Precio (€)
<b>1 elemento</b>	WL5513	12	<b>3,42</b>

horizontal:

<b>2 elementos</b>	WL5723	25	<b>6,26</b>
<b>3 elementos</b>	WL5733	20	<b>9,71</b>
<b>4 elementos</b>	WL5743	25	<b>17,24</b>
<b>5 elementos</b>	WL5753	6	<b>24,09</b>

vertical:

<b>2 elementos</b>	WL5623	25	<b>6,26</b>
<b>3 elementos</b>	WL5633	20	<b>9,71</b>
<b>4 elementos</b>	WL5643	25	<b>17,24</b>
<b>5 elementos</b>	WL5653	6	<b>24,09</b>

## Cajas de superficie, lumina intense



WL5810

### 1 elemento

Descripción	Referencia	Emb.	Precio (€)
<b>Blanco polar</b>	WL5810	12	<b>7,14</b>
<b>Plata</b>	WL5812	12	<b>19,19</b>
<b>Negro</b>	WL5813	12	<b>19,19</b>

### 2 elementos

Descripción	Referencia	Emb.	Precio (€)
<b>Blanco polar</b>	WL5820	6	<b>10,87</b>
<b>Plata</b>	WL5822	6	<b>29,16</b>
<b>Negro</b>	WL5823	6	<b>29,16</b>

### 3 elementos

Descripción	Referencia	Emb.	Precio (€)
<b>Blanco polar</b>	WL5830	5	<b>16,30</b>
<b>Plata</b>	WL5832	5	<b>43,73</b>
<b>Negro</b>	WL5833	5	<b>43,73</b>

## Elementos monobloc, lumina intense



WL8010

### Interruptor monobloc, blanco polar

<b>Simple</b>	WL8010	12	<b>5,47</b>
<b>Doble</b>	WL8020	12	<b>8,48</b>

• consultar disponibilidad

**Nota:** En instalaciones en paredes de tabique hueco, se recomienda dejar la caja de empotrar enrasada con la pared con el fin de que la instalación de nuestras series de mecanismos se realice de la manera que se han diseñado. Recomendamos el uso de una sierra de corona con avellanador.



## Interruptores simples



### Interruptor

Descripción	Referencia	Emb.	Precio (€)
<b>Blanco polar</b>	WL0010	12	<b>4,75</b>
<b>Plata</b>	WL0012	12	<b>5,99</b>
<b>Negro</b>	WL0013	12	<b>5,99</b>

WL0010

- unipolar
- conectores rápidos



### Conmutador

Descripción	Referencia	Emb.	Precio (€)
<b>Blanco polar</b>	WL0020	12	<b>6,13</b>
<b>Plata</b>	WL0022	12	<b>7,63</b>
<b>Negro</b>	WL0023	12	<b>7,63</b>

WL0020

- unipolar
- conectores rápidos



### Cruzamiento

Descripción	Referencia	Emb.	Precio (€)
<b>Blanco polar</b>	WL0030	12	<b>12,21</b>
<b>Plata</b>	WL0032	12	<b>15,23</b>
<b>Negro</b>	WL0033	12	<b>15,23</b>

WL0030

- con conectores rápidos



### Interruptor bipolar

Descripción	Referencia	Emb.	Precio (€)
<b>Blanco polar</b>	WL0060	12	<b>13,54</b>
<b>Plata</b>	WL0062	12	<b>17,08</b>
<b>Negro</b>	WL0063	12	<b>17,08</b>

WL0060

- 2 circuitos eléctricos independientes
- con conectores rápidos

## Pulsador



### Pulsador

Descripción	Referencia	Emb.	Precio (€)
<b>Blanco polar</b>	WL0110	12	<b>7,37</b>
<b>Plata</b>	WL0112	12	<b>9,20</b>
<b>Negro</b>	WL0113	12	<b>9,20</b>

WL0110

- pulsador unipolar
- con conectores rápidos

## Mecanismo con indicador luminoso



### Interruptor

Descripción	Referencia	Emb.	Precio (€)
<b>Blanco polar</b>	WL0210	12	<b>5,50</b>
<b>Plata</b>	WL0212	12	<b>6,94</b>
<b>Negro</b>	WL0213	12	<b>6,94</b>

WL0210

- unipolar
- lámpara de neón incluida

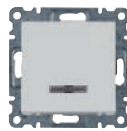

### Conmutador con indicador luminoso

Descripción	Referencia	Emb.	Precio (€)
<b>Blanco polar</b>	WL0220	12	<b>6,93</b>
<b>Plata</b>	WL0222	12	<b>8,75</b>
<b>Negro</b>	WL0223	12	<b>8,75</b>

WL0220

- unipolar
- lámpara de neón incluida



### Interruptor doble con indicador luminoso

Descripción	Referencia	Emb.	Precio (€)
<b>Blanco polar</b>	WL0240	12	<b>9,35</b>
<b>Plata</b>	WL0242	12	<b>11,79</b>
<b>Negro</b>	WL0243	12	<b>11,79</b>

WL0240

- unipolar
- lámpara de neón incluida



### Pulsador con indicador luminoso

Descripción	Referencia	Emb.	Precio (€)
<b>Blanco polar</b>	WL0410	12	<b>13,08</b>
<b>Plata</b>	WL0412	12	<b>16,49</b>
<b>Negro</b>	WL0413	12	<b>16,49</b>

WL0410

- unipolar
- lámpara de neón incluida

**Nota:** todos los interruptores de esta página son 10 AX, 250 V~

Esquemas de conexionado pág. 204 y 205

## Interruptores múltiples



WL0040

### Interruptor doble

Descripción	Referencia	Emb.	Precio (€)
<b>Blanco polar</b>	WL0040	12	<b>8,07</b>
<b>Plata</b>	WL0042	12	<b>10,18</b>
<b>Negro</b>	WL0043	12	<b>10,18</b>

- con conectores rápidos



WL0050

### Conmutador doble

Descripción	Referencia	Emb.	Precio (€)
<b>Blanco polar</b>	WL0050	12	<b>9,01</b>
<b>Plata</b>	WL0052	12	<b>11,25</b>
<b>Negro</b>	WL0053	12	<b>11,25</b>

- con bornes de tornillos



WL0070

### Interruptor triple

Descripción	Referencia	Emb.	Precio (€)
<b>Blanco polar</b>	WL0070	12	<b>12,08</b>
<b>Plata</b>	WL0072	12	<b>15,25</b>
<b>Negro</b>	WL0073	12	<b>15,25</b>

- 3 circuitos eléctricos independientes
- con bornes de tornillos

## Mecanismo para persiana



WL0310

### Interruptor para persiana

Descripción	Referencia	Emb.	Precio (€)
<b>Blanco polar</b>	WL0310	12	<b>19,72</b>
<b>Plata</b>	WL0312	12	<b>24,59</b>
<b>Negro</b>	WL0313	12	<b>24,59</b>

- con bloqueo eléctrico para evitar la conexión simultánea en ambas direcciones
- unipolar
- terminales de conexión rápida



WL0320

### Pulsador para persiana

Descripción	Referencia	Emb.	Precio (€)
<b>Blanco polar</b>	WL0320	12	<b>20,14</b>
<b>Plata</b>	WL0322	12	<b>25,42</b>
<b>Negro</b>	WL0323	12	<b>25,42</b>

- con bloqueo eléctrico para evitar la conexión simultánea en ambas direcciones
- unipolar, contacto NA
- terminales de conexión rápida

## Tomas



WL1060

### Toma Schuko

Descripción	Referencia	Emb.	Precio (€)
<b>Blanco polar</b>	WL1060	12	<b>5,11</b>
<b>Plata</b>	WL1062	12	<b>6,30</b>
<b>Negro</b>	WL1063	12	<b>6,30</b>

16 A, 250 V~

- bipolar con conexión a tierra
- protección infantil
- con bornes de tornillos
- productos certificados VDE y AENOR



WL1160

### Toma Schuko con tapa

Descripción	Referencia	Emb.	Precio (€)
<b>Blanco polar</b>	WL1160	12	<b>10,21</b>
<b>Plata</b>	WL1162	12	<b>12,89</b>
<b>Negro</b>	WL1163	12	<b>12,89</b>

16 A, 250 V~

- bipolar con conexión a tierra
- protección infantil
- con bornes de tornillos
- opción IP44 con kit de sellado ref. WL7023
- productos certificados VDE y AENOR

## Kit de sellado IP44



WL7023

### Kit de sellado IP44

Descripción	Referencia	Emb.	Precio (€)
<b>Toma de corriente</b>	WL7023	18	<b>4,25</b>
<b>Interruptor/Conmutador simple</b>	53 1884	10	<b>2,41</b>

- Para alcanzar un grado de protección IP44 en tomas de corriente con conexión a tierra y tapa



WL1040

### Toma de corriente francesa

Descripción	Referencia	Emb.	Precio (€)
<b>Blanco polar</b>	WL1040	12	<b>8,80</b>
<b>Plata</b>	WL1042	12	<b>11,09</b>
<b>Negro</b>	WL1043	12	<b>11,09</b>

## Tomas telefonía RJ11

### Toma teléfono simple



WL2010

Descripción	Referencia	Emb.	Precio (€)
<b>Blanco polar</b>	WL2010	12	<b>12,26</b>
<b>Plata</b>	WL2012	12	<b>15,29</b>
<b>Negro</b>	WL2013	12	<b>15,29</b>

### Toma teléfono doble

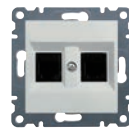

WL2020

Descripción	Referencia	Emb.	Precio (€)
<b>Blanco polar</b>	WL2020	12	<b>22,37</b>
<b>Plata</b>	WL2022	12	<b>28,23</b>
<b>Negro</b>	WL2023	12	<b>28,23</b>

- 2 x toma RJ11 cat.3

## Tomas telefonía/datos

### Toma RJ11 + RJ45



WL2210

Descripción	Referencia	Emb.	Precio (€)
<b>Blanco polar</b>	WL2210	12	<b>23,04</b>
<b>Plata</b>	WL2212	12	<b>29,09</b>
<b>Negro</b>	WL2213	12	<b>29,09</b>

- 1 x toma RJ11 cat. 3
- 1 x 1 x toma RJ45 cat. 5 UTP con protección contra el polvo

## Soporte Keystone Jack

### Soporte doble para Keystone Jack



WL2320

Descripción	Referencia	Emb.	Precio (€)
<b>Blanco polar</b>	WL2320	12	<b>5,41</b>
<b>Plata</b>	WL2322	12	<b>6,84</b>
<b>Negro</b>	WL2323	12	<b>6,84</b>

- para montaje de módulos RJ45 estándar Keystone Jack
- se suministra con 1 espacio ciego

## Soporte para fibra óptica

### Soporte FO duplex-SC



WL2410

Descripción	Referencia	Emb.	Precio (€)
<b>Blanco polar</b>	WL2410	12	<b>10,45</b>
<b>Plata</b>	WL2412	12	<b>13,19</b>
<b>Negro</b>	WL2413	12	<b>13,19</b>

- consultar disponibilidad

## Tomas datos RJ45 simples

### RJ45 cat. 5e UTP



WL2110

Descripción	Referencia	Emb.	Precio (€)
<b>Blanco polar</b>	WL2110	12	<b>18,54</b>
<b>Plata</b>	WL2112	12	<b>23,38</b>
<b>Negro</b>	WL2113	12	<b>23,38</b>

### RJ45 cat. 6 UTP

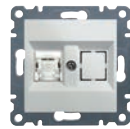

WL2150

Descripción	Referencia	Emb.	Precio (€)
<b>Blanco polar</b>	WL2150	12	<b>19,65</b>
<b>Plata</b>	WL2152	12	<b>22,83</b>
<b>Negro</b>	WL2153	12	<b>22,83</b>

### RJ45 cat. 6 FTP



WL2170

Descripción	Referencia	Emb.	Precio (€)
<b>Blanco polar</b>	WL2170	12	<b>25,56</b>
<b>Plata</b>	WL2172	12	<b>32,27</b>
<b>Negro</b>	WL2173	12	<b>32,27</b>

## Tomas RJ45 dobles

### 2xRJ45 cat 5e UTP



WL2120

Descripción	Referencia	Emb.	Precio (€)
<b>Blanco polar</b>	WL2120	12	<b>37,06</b>
<b>Plata</b>	WL2122	12	<b>46,78</b>
<b>Negro</b>	WL2123	12	<b>46,78</b>

### 2xRJ45 cat 6 UTP



WL2160

Descripción	Referencia	Emb.	Precio (€)
<b>Blanco polar</b>	WL2160	12	<b>43,44</b>
<b>Plata</b>	WL2162	12	<b>54,86</b>
<b>Negro</b>	WL2163	12	<b>54,86</b>

### 2xRJ45 cat 6 FTP



WL2180

Descripción	Referencia	Emb.	Precio (€)
<b>Blanco polar</b>	WL2180	12	<b>52,40</b>
<b>Plata</b>	WL2182	12	<b>66,14</b>
<b>Negro</b>	WL2183	12	<b>66,14</b>

- todas las tomas RJ45 incorporan protección contra el polvo

## Tomas de antena



### Toma RTV

WL3010

Descripción	Referencia	Emb.	Precio (€)
<b>Blanco polar</b>	WL3010	12	<b>22,77</b>
<b>Plata</b>	WL3012	12	<b>28,76</b>
<b>Negro</b>	WL3013	12	<b>28,76</b>

Frecuencia 5-862 MHz;  
Impedancia 75 W  
Frecuencia TV 5-68 | 118-862 MHz;  
Frecuencia R 88-108 MHz;  
Atenuación: TV  $\leq$  2 dB; R  $\leq$  1.5 dB

- para instalaciones individuales analógicas y digitales DVB-T
- para la recepción de señal terrestre y por cable
- para estructura en árbol
- tensión DC en salida TV
- bornes de tornillos



### Toma RTV de paso

WL3020

Descripción	Referencia	Emb.	Precio (€)
<b>Blanco polar</b>	WL3020	12	<b>22,77</b>
<b>Plata</b>	WL3022	12	<b>28,76</b>
<b>Negro</b>	WL3023	12	<b>28,76</b>

Frecuencia 5-862 MHz;  
Impedancia 75 W  
Frecuencia TV 5-68 | 118-862 MHz;  
Frecuencia R 88-108 MHz;  
Atenuación: TV  $\leq$  2 dB; R  $\leq$  1.5 dB  
R 10.8-10.9 dB;  
IN->OUT:1.1 dB;

- para instalaciones individuales analógicas y digitales DVB-T
- para la recepción de señal terrestre y por cable
- para estructura en árbol y línea principal
- con bornes de tornillos



### Toma RTV/SAT

WL3110

Descripción	Referencia	Emb.	Precio (€)
<b>Blanco polar</b>	WL3110	12	<b>24,83</b>
<b>Plata</b>	WL3112	12	<b>31,32</b>
<b>Negro</b>	WL3113	12	<b>31,32</b>

Frecuencia 5-2200 MHz;  
Impedancia 75 W  
Frecuencia TV 10-68 | 125-862 MHz;  
Frecuencia R 88-108 MHz;  
Frecuencia SAT 950-2200 MHz;  
Atenuación: TV  $\leq$  2 dB; R  $\leq$  1.7 dB;  
SAT  $\leq$  2.6 dB

- para instalaciones individuales analógicas y digitales DVB-T
- para la recepción de señal terrestre y de satélite
- tensión DC en salida SAT



### Toma RTV / SAT de paso

WL3120

Descripción	Referencia	Emb.	Precio (€)
<b>Blanco polar</b>	WL3120	12	<b>24,83</b>
<b>Plata</b>	WL3122	12	<b>31,32</b>
<b>Negro</b>	WL3123	12	<b>31,32</b>

Frecuencia 5-2400 MHz;  
Impedancia 75 W  
Frecuencia TV 5-70 | 120-862 MHz;  
Frecuencia R 88-108 MHz;  
Frecuencia SAT 950-2400 MHz;  
Atenuación: TV 10 dB; R 12 dB;  
SAT 8/6 dB;  
IN->OUT: 3.7-7 dB;

- para instalaciones individuales analógicas y digitales DVB-T
- para la recepción de señal terrestre y de satélite
- tensión DC en salida SAT
- para estructura en árbol y línea principal
- una entrada común
- bornes de tornillos

## Accesorios



### Tapa RTV

WL6320

Descripción	Referencia	Emb.	Precio (€)
<b>Blanco polar</b>	WL6320	18	<b>5,43</b>
<b>Plata</b>	WL6322	18	<b>6,77</b>
<b>Negro</b>	WL6323	18	<b>6,77</b>

- con posibilidad de romper los tapones ciegos de la entrada SAT

**Nota:** Para tomas Televisión

- Los bastidores de toma de televisión son diferentes al resto de la gama lumina

## Reguladores



WL4010

### Regulador rotativo

Descripción	Referencia	Emb.	Precio (€)
<b>Blanco polar</b>	WL4010	12	<b>61,70</b>
<b>Plata</b>	WL4012	12	<b>77,89</b>
<b>Negro</b>	WL4013	12	<b>77,89</b>

lámparas incandescentes 60 – 600 W;  
lámparas halógenas 230V 60 – 600 W;  
250 V~, 50 Hz

- con mando rotativo
- con protección contra cortocircuitos y sobrecargas (fusibles)
- con indicador LED
- con bornes de tornillos



WL4030

### Regulador pulsación

Descripción	Referencia	Emb.	Precio (€)
<b>Blanco polar</b>	WL4030	12	<b>99,33</b>
<b>Plata</b>	WL4032	12	<b>123,79</b>
<b>Negro</b>	WL4033	12	<b>123,79</b>

- cargas resistivas 60-300W
- 250 V~, 50Hz

## Tapa ciega

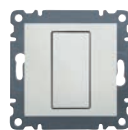

WL7010

### Tapa ciega

Descripción	Referencia	Emb.	Precio (€)
<b>Blanco polar</b>	WL7010	12	<b>7,64</b>
<b>Plata</b>	WL7012	12	<b>9,53</b>
<b>Negro</b>	WL7013	12	<b>9,53</b>

- El bastidor de la tapa ciega es diferente al resto de la gama lumina

## Salida de cables



WL7030

### Tapa ciega

Descripción	Referencia	Emb.	Precio (€)
<b>Blanco polar</b>	WL7030	12	<b>7,35</b>
<b>Plata</b>	WL7032	12	<b>9,15</b>
<b>Negro</b>	WL7033	12	<b>9,15</b>

- Consultar disponibilidad

## Toma altavoz



WL3310

### Toma altavoz

Descripción	Referencia	Emb.	Precio (€)
<b>Blanco polar</b>	WL3310	12	<b>18,90</b>
<b>Plata</b>	WL3312	12	<b>23,85</b>
<b>Negro</b>	WL3313	12	<b>23,85</b>

## Tarjetero hotel



WL0510

### Tarjetero hotel

Descripción	Referencia	Emb.	Precio (€)
<b>Blanco polar</b>	WL0510	12	<b>26,68</b>
<b>Plata</b>	WL0512	12	<b>33,70</b>
<b>Negro</b>	WL0513	12	<b>33,70</b>

## Teclas con pictogramas

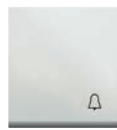

WL6010

### Tecla con el símbolo "campana"

Descripción	Referencia	Emb.	Precio (€)
<b>Blanco polar</b>	WL6010	18	<b>1,92</b>
<b>Plata</b>	WL6012	18	<b>2,44</b>
<b>Negro</b>	WL6013	18	<b>2,44</b>



WL6020

### Tecla con el símbolo "luz"

Descripción	Referencia	Emb.	Precio (€)
<b>Blanco polar</b>	WL6020	18	<b>1,92</b>
<b>Plata</b>	WL6022	18	<b>2,44</b>
<b>Negro</b>	WL6023	18	<b>2,44</b>



WL6030

### Tecla con el símbolo "escalera"

Descripción	Referencia	Emb.	Precio (€)
<b>Blanco polar</b>	WL6030	18	<b>1,92</b>
<b>Plata</b>	WL6032	18	<b>2,44</b>
<b>Negro</b>	WL6033	18	<b>2,44</b>

## Teclas c/ pictogramas e indicador luminoso



WL6110

### Tecla con el símbolo "campana"

Descripción	Referencia	Emb.	Precio (€)
<b>Blanco polar</b>	WL6110	18	<b>2,11</b>
<b>Plata</b>	WL6112	18	<b>2,83</b>
<b>Negro</b>	WL6113	18	<b>2,83</b>



WL6120

### Tecla con el símbolo "luz"

Descripción	Referencia	Emb.	Precio (€)
<b>Blanco polar</b>	WL6120	18	<b>2,11</b>
<b>Plata</b>	WL6122	18	<b>2,83</b>
<b>Negro</b>	WL6123	18	<b>2,83</b>



WL6130

### Tecla con el símbolo "escalera"

Descripción	Referencia	Emb.	Precio (€)
<b>Blanco polar</b>	WL6130	18	<b>2,11</b>
<b>Plata</b>	WL6132	18	<b>2,83</b>
<b>Negro</b>	WL6133	18	<b>2,83</b>

- montaje de las teclas en mecanismos con indicador luminoso

## Marco intermedio



WL5310

### Marco intermedio 50x50

Descripción	Referencia	Emb.	Precio (€)
<b>Blanco polar</b>	WL5310	24	<b>1,29</b>
<b>Plata</b>	WL5312	24	<b>1,64</b>
<b>Negro</b>	WL5313	24	<b>1,64</b>

- para tapa timbre, añadir las referencias berker: 1474 09 - blanco polar  
1474 14 04 - aluminio\*  
1474 16 06 - antracita\*  
y la referencia berker BBH03
- Los colores pueden variar
- Para toma fibra óptica, añadir la referencia berker: 1480 09 - blanco polar

## Adaptador 45 x 45

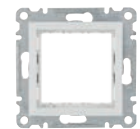

WL2510

### Adaptador 45 x 45

Descripción	Referencia	Emb.	Precio (€)
<b>Blanco polar</b>	WL2510	24	<b>4,52</b>
<b>Plata</b>	WL2512	24	<b>5,69</b>
<b>Negro</b>	WL2513	24	<b>5,69</b>

# Series de mecanismos Series berker

El sistema modular con mayor número de estéticas y tipos de materiales. La amplitud de formas, colores y materiales (cristal, acero, aluminio, porcelana, hormigón,...) permite aunar los conceptos de Calidad, Funcionalidad y Diseño. Soluciones adecuadas para la decoración de cualquier ambiente, en todas sus funcionalidades, tanto en mecanismo convencional y electrónico como en control y gestión de edificios.



# series berker

pág.

concepto modular	62
mecanismos, ventajas	64
tomas de corriente, ventajas	66
mecanismos	68
reguladores rotativos LED	81
berker S.1	82
berker B.3	84
berker B.7	86
berker S.1 / B.3 / B.7	88
berker Q.1	98
berker Q.3	100
berker Q.7	102
berker Q.1 / Q.3 / Q.7	104
berker K.1	114
berker K.5	116
berker K.1 / K.5	118
berker R.1	126
berker R.3	128
berker R.8	130
berker R.1 / R.3 / R.8	132
Serie R.classic	146
Serie 1930	148
Serie 1930 Porzellan made by Rosenthal	150
Serie Glas	152
Serie R.classic / 1930 / Glas	154

# Concepto modular de la aplicación...

Aquí te mostramos cómo puedes montar un producto completo a partir de tres elementos: mecanismo, marco y tecla/tapa

01

Aplicación

**Seleccione mecanismo**  
en el capítulo de:  
**Mecanismos modulares**

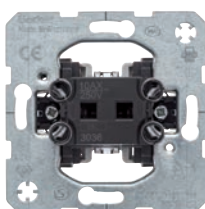

02

**Elige el diseño del marco**  
en el capítulo:  
**berker B.3**



Conmutador

ej.: conmutador  
n° de referencia: 3036

ej.: marco 1 elemento aluminio/blanco polar  
n° de referencia: 1011 39 04

Mecanismos electrónicos



berker K.1



Regulador

ej.: Mecanismo regulador rotativo  
n° de referencia: 2830 10

ej.: marco 1 elemento blanco polar  
n° de referencia: 1313 70 09

Mecanismos electrónicos



berker S.1



Toma RJ doble

ej.: mecanismo RJ45 doble  
n° de referencia: 4555 01

ej.: marco 1 elemento blanco polar, brillo  
n° de referencia: 1011 99 09

# ... al producto completo

## 03

### Encuentra una tecla o tapa

en el capítulo:

**berker S.1/B.3/B.7**

**Teclas y tapas**



=

### Producto completo



ej.: tecla blanco polar, mate  
nº de referencia: 1620 19 09

Interruptor  
Diseño: berker B.3

### berker K.1/K.5

**Teclas y mecanismos centrales**



=



ej.: tapa mando rotativo blanco polar, brillo  
nº de referencia: 1135 70 09

Dimmer mando rotativo  
Diseño: berker K.1

### berker S.1/B.3/B.7 Glas

**Teclas y mecanismos centrales**



=



ej.: tapa central para toma teléfono / red doble  
nº de referencia: 1409 89 89

Toma red doble  
Diseño: berker S.1

# Beneficios del mecanismo

Como inventor del sistema modular, berker dispone de un único mecanismo para distintas estéticas. Los mecanismos actuales se dejan en la pared. Sólo se sustituyen las estéticas. Incluso si se desea un interruptor de control o un interruptor iluminado, el mecanismo siempre es el mismo. Esto significa para Ud. lo siguiente:

- No hay mecanismos equivocados en la instalación
- Stock mínimo
- Satisfacción del cliente a largo plazo

## Funcionalidad y diseño

El diseño modular probado y testeado y el ángulo extremadamente plano de solo 3.5° hacen que el interruptor se vea muy plano en la pared. Para que la instalación sea fácil se creó el concepto de garras Flexolift.

Las garras se ajustan a ras y se ven forzadas automáticamente a su posición cuando se sueltan. En la parte posterior del interruptor se encuentra un grabado láser del diagrama del circuito, el símbolo gráfico, y la longitud de tramo de conductor sin aislamiento necesario para la conexión. En la parte frontal, destaca la referencia del mecanismo para poder identificarlo de manera muy sencilla. Una protección alrededor de los tornillos garra previene daños a los conductores. Las teclas son guiadas principalmente con la ayuda de monturas en el mecanismo, haciendo que el mecanismo sea más fácil de usar.



**- Datos marcados en la parte frontal**

Referencia, características técnicas, fecha de fabricación



**- Bastidor de alta calidad**

Resistente, sin esquinas puntiagudas y con opciones de atornillado adicionales



**- Diseño de bastidor óptimo**

Marcado para alineación precisa durante la instalación



**- Angulo de 3,5° de basculación**

Para una apariencia plana



**- Diseño modular**

Apto para todos los tipos de teclas



**- Amplio espacio y fácil acceso**

a los tornillos para las garras de sujeción



**- Asiento preciso de las teclas sobre el mecanismo**



**- Posición del indicador luminoso**

Puede utilizarse como indicador o luz de orientación



**- Tecla de desconexión con palanca**

Mayor facilidad para la desconexión de los cables conductores



**- Datos marcados en la parte trasera**

Esquema y símbolo de conexión, longitud de tramo de conductor sin aislamiento necesario para la conexión

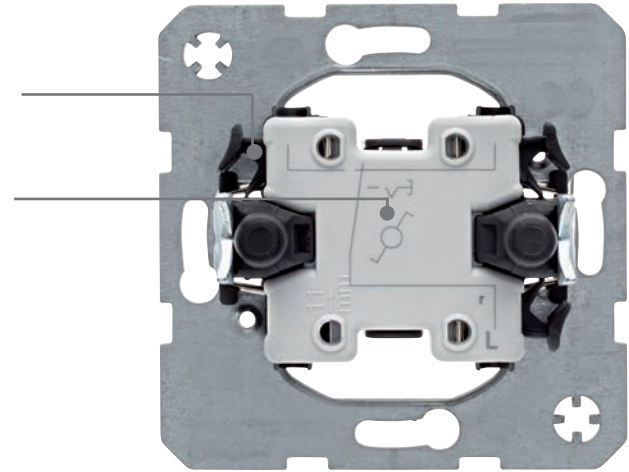
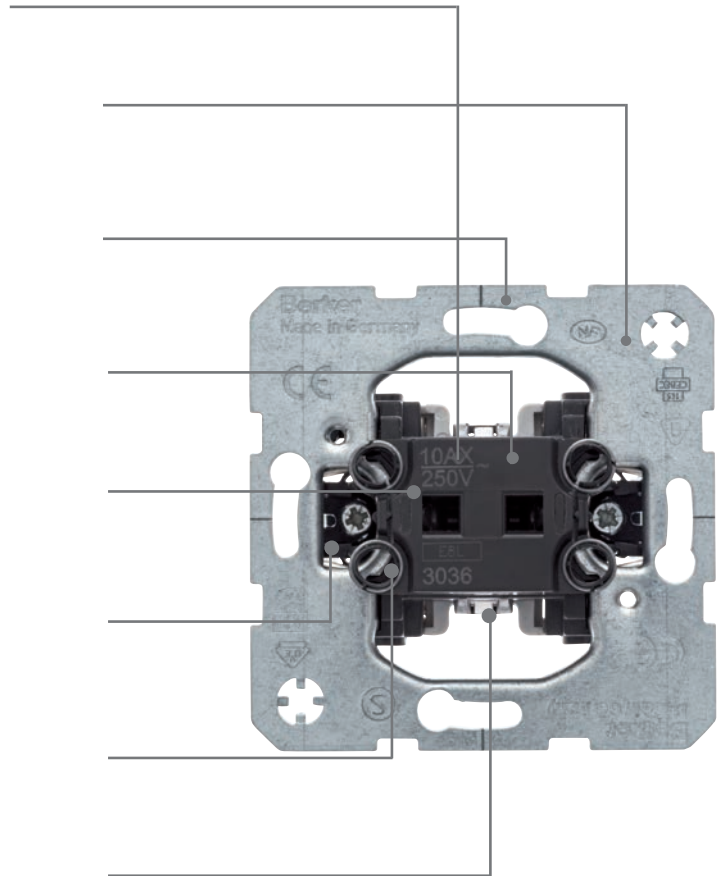

**- Protección de los cables conductores**

Los tornillos para el despliegue de las garras de sujeción están provistos de una protección que impide el daño de los cables conductores



**- Garras Flexolift®**

Las garras se abaten al desmontar el interruptor, quedando perfectamente plegadas

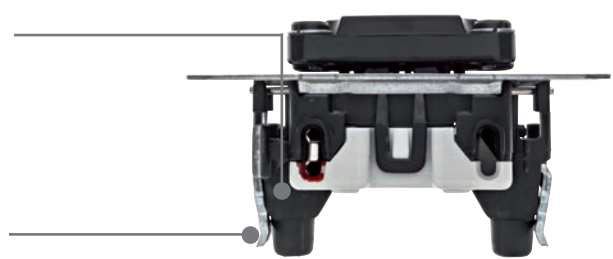

**- Profundidad mínima de instalación**

con el máximo espacio para la instalación del mecanismo en paredes huecas



# Ventajas de las tomas de corriente

berker ha estado produciendo tomas de corriente durante más de 90 años. Miles de ellas a diario utilizando materiales de alta calidad, con diseños exclusivos.

Hemos utilizado nuestros años de experiencia y de ideas innovadoras para optimizar los pequeños detalles de nuestras tomas de corriente, con el fin de facilitar el trabajo diario a nuestros clientes.

- Más fácil
- Más rápido
- Más seguro
- Stock mínimo

## Diseño compacto y base resistente

El bastidor con una superficie de alta calidad es muy resistente, no tiene esquinas puntiagudas y se le ha modificado el contorno para que la alineación y el atornillado durante la instalación sean considerablemente más fáciles.

Los conductores ahora son más fáciles de insertar y atornillar dentro de los terminales.

La geometría de garra abierta previene daños a los conductores durante el ensamblaje.

La posibilidad de un voltaje parasitario en el bastidor se previene con una separación voltaica. Y las garras Flexolift se retraen completamente dentro de la base.

Los tornillos estrella proveen un máximo agarre a los destornilladores.



- **Bastidor de alta calidad**  
Sin esquinas puntiagudas y puntos adicionales de sujeción para paredes huecas



- **Diseño de bastidor óptimo**  
Marcado para facilitar el alineado durante la instalación



- **Marcas de prueba en la base**  
para visibilidad en cada fase del montaje



- **Tornillos de las garras**  
para el enroscado óptimo 3 veces más rápido de instalar y extraer



- **Etiqueta en el bastidor**  
para el etiquetado claro de los circuitos eléctricos



- **Tornillos estrella en la tapa**  
para el perfecto agarre durante el ensamblaje



- **Marcado en la base**  
Longitud de tramo de conductor sin aislamiento necesario para la conexión



- **Toma cerrada robusta**  
para una instalación segura



- **Separación voltaica del bastidor**  
para trabajar de forma segura sin voltaje parasitario



- **Geometría de la garra**  
que previene daños a los conductores durante la instalación



- **Las garras en la base**  
de forma que completamente retraídas son fáciles de instalar y colocar en la caja



- **Diseño terminal optimizado**  
para fácil inserción de los conductores



- **Terminales con tornillos**  
para la conexión rápida y segura de posicionamiento de los conductores . Sólo en tomas marcadas con terminales con tornillos

- **Referencia independiente de la tapa**

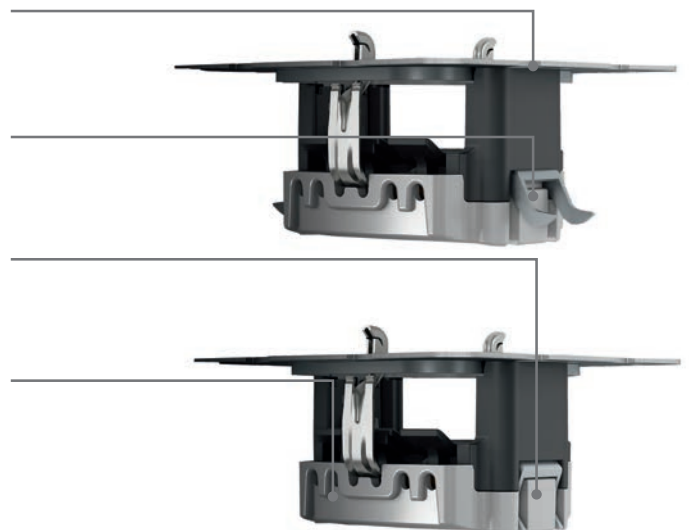
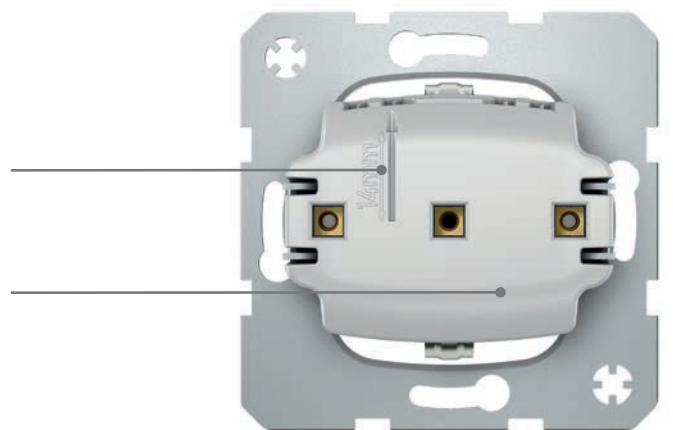
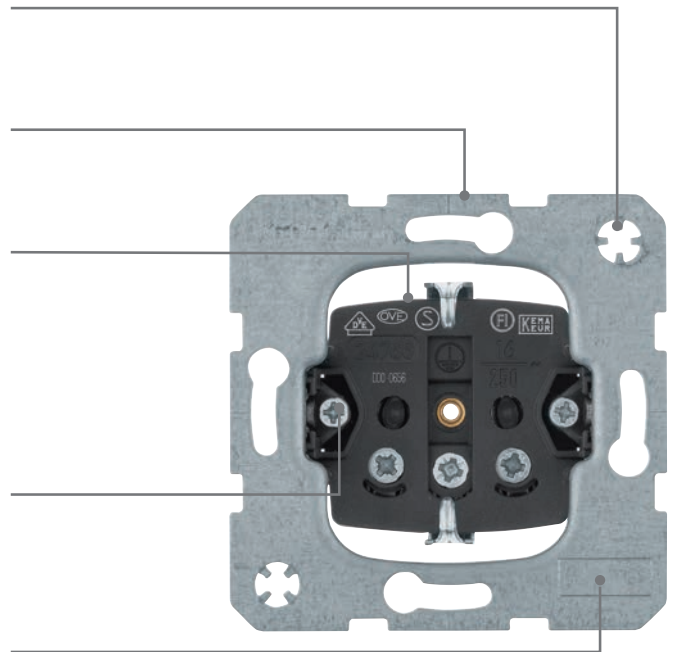

**Nota: no se puede instalar cualquier enchufe en España, sólo los normalizados son seguros**

El REBT hace referencia a la serie de normas UNE 20315 "Bases de toma de corriente y clavijas para usos domésticos y análogos" y a los tipos de bases de toma de corriente aptas para su instalación en España.

# Mecanismos series berker para todas tus ideas

Con nuestras series de mecanismos berker tienes todo un mundo de posibilidades. Descubre la amplia gama de diseños y materiales. Elige clásico, clásico moderno o contemporáneo, la decisión es tuya. Diseños que se adaptan a cada interior perfeccionándolo.



## Ventajas:

---

- Kit de sellado IP44. Muchas de las series berker pueden convertirse en IP44 tan solo añadiendo un kit de sellado, disponible para interruptores y tomas de corriente.

---

- Made in Europe.

---

- Individualismo. En Hager encontrarás la mayor variedad de formas. Y, con ellas, soluciones individuales para todo concepto arquitectónico.

---

- Discreto diseño, totalmente adaptable a cualquier entorno o decoración.

---

## Características técnicas:

---

- 17 líneas de diseño diferentes

---

- Variedad de materiales: plástico, aluminio, cristal, acero, hormigón, madera, piel, pizarra, porcelana, fibra acrílica...

---

- Colores y acabados: blanco, blanco polar, antracita, aluminio, negro, rojo, naranja, marrón. Acabado mate, brillo, lacado, aluminio anodizado...

---

- Certificado VDE: para todos los artículos de la serie berker para la cual este certificado es posible, llevan esta marca.

---

# Más ventajas

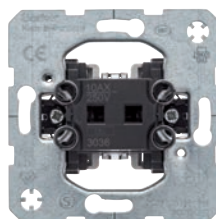
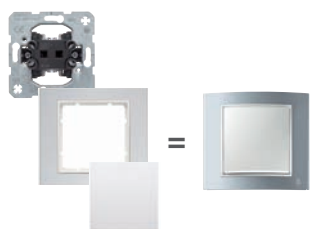

## 01

### Excelencia en el diseño

Así lo avalan los prestigiosos concursos nacionales e internacionales que las series de mecanismos berker han ganado una y otra vez.

## 02

### Concepto modular

3 referencias para construir un punto completo: mecanismo, tecla/tapa y marco.

## 03

### Mecanismo único

En todos los sentidos y que además, permite que el stock se reduzca porque únicamente es necesario tener estéticas.

## 04

### Calidad de los materiales

Materiales nobles, fabricación, asesoramiento y servicios: Hager ofrece máxima calidad en todos los ámbitos.

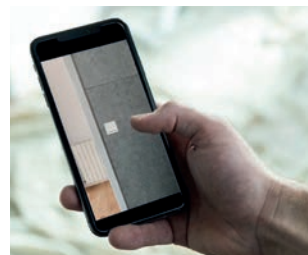
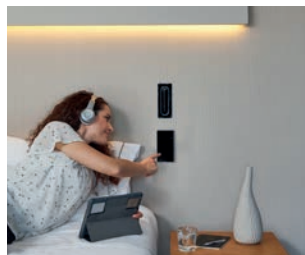
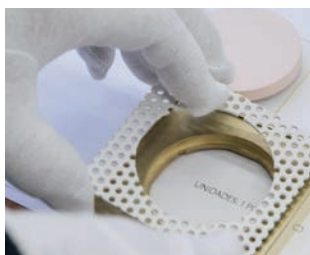

## 05

### Manufaktur

Personaliza tu mecanismo con Manufaktur: el Servicio de Hager Group que encarna la forma moderna y sin complicaciones de la fabricación especial.

## 06

### Teclados KNX

Las series de mecanismos y las soluciones KNX de Hager están abiertas a las tendencias presentes y también a las venideras.

## 07

### Proyectos de referencia

Proyectos exitosos recientes en los que Hager ha participado. Pueden consultarse en nuestra web: [www.hager.com/es](http://www.hager.com/es)

## 08

### App series Hager

Escoge para cada estancia el acabado y funcionalidades deseadas. Obtén un listado de referencias, descripciones y precios para valorar tu instalación.

## Interruptores

**Mecanismos de mando**

Descripción	Referencia	Emb.	Precio (€)
<b>Interruptor on/off 10AX, 250V</b>	3031	10	<b>4,91</b>
<b>Conmutador 10AX, 250V</b>	3036	10	<b>5,61</b>
<b>Cruzamiento 10AX, 250V</b>	3037	10	<b>11,63</b>

3036

Descripción	Referencia	Emb.	Precio (€)
<b>Conmutador 10AX, 250V pared hueca</b>	3036 50	10	<b>10,92</b>

\* Sin garras

Descripción	Referencia	Emb.	Precio (€)
<b>Interruptor bipolar on/off 10AX, 250V</b>	3032	10	<b>12,29</b>
<b>Interruptor bipolar on/off 16AX, 250V</b>	3032 12*	10	<b>26,75</b>
<b>Interruptor tripolar on/off 16AX, 400V</b>	3033 03*	10	<b>20,87</b>

3032

Descripción	Referencia	Emb.	Precio (€)
<b>Doble interruptor on/off 10AX, 250V</b>	3035	10	<b>7,36</b>
<b>Doble interruptor on/off 10AX, 250V para pared hueca</b>	3035 50	10	<b>16,50</b>

\* Sin garras

Descripción	Referencia	Emb.	Precio (€)
<b>Doble conmutador, terminales de entrada aislados</b>	3038 08	10	<b>18,30</b>

Descripción	Referencia	Emb.	Precio (€)
<b>Interruptor 3x1 polo off 16AX, 400V</b>	63 3023*	10	<b>29,62</b>

Descripción	Referencia	Emb.	Precio (€)
<b>Pulsador izqdo. + conmutador derecho</b>	5038 08 01	10	<b>14,80</b>
<b>Pulsador dcho. + conmutador izqdo.</b>	5038 08 02	10	<b>14,80</b>

\* Con bornes a tornillo

**Interruptor de tirador**

Descripción	Referencia	Emb.	Precio (€)
<b>Conmutador 10AX, 250V</b>	3966	10	<b>18,99</b>

3966

### Interruptor rotativo bipolar

Descripción	Referencia	Emb.	Precio (€)
<b>20A para 2,5-4 mm<sup>2</sup></b>	3862*	10	<b>103,75</b>
<b>25A para 2,5-6 mm<sup>2</sup></b>	3862 01	10	<b>117,11</b>

\* Con bornes a tornillo

### Interruptor rotativo 3 posiciones 16A, 250V

Descripción	Referencia	Emb.	Precio (€)
<b>Posición 0-1-2-3</b>	3861 03	10	<b>34,12</b>
<b>Posición 2-1-3</b>	3861 13	10	<b>57,75</b>

3861 01

Con bornes a tornillo

### Interruptor llave para cerradura perfil semicilíndrico

Descripción	Referencia	Emb.	Precio (€)
<b>Interrup./conmutador bipolar 10A, 250V</b>	3826 10*	10	<b>150,43</b>

3826 10

\* Con bornes a tornillo

## Pulsadores

**Pulsadores 10A, 250 V**

Descripción	Referencia	Emb.	Precio (€)
<b>Unipolar NA</b>	5031	10	<b>6,02</b>
<b>Unipolar, 1 entrada línea y 2 salidas (NA o NC)</b>	5036	10	<b>8,74</b>
<b>Unipolar, 3 salidas 1NA + 2 contactos auxiliares libre de potencial</b>	5031 01	10	<b>11,18</b>
<b>Unipolar, dos circuitos diferentes alternativos a/ entrada-salida NA, b/entrada-salida NC</b>	5032 03	10	<b>19,05</b>

5031

Descripción	Referencia	Emb.	Precio (€)
<b>Unipolar NA para pared hueca</b>	5031 50	10	<b>12,42</b>

Descripción	Referencia	Emb.	Precio (€)
<b>Unipolar, terminal de entrada común, salidas 2NA = doble pulsador</b>	5035	10	<b>11,18</b>
<b>Unipolar, dos circuitos diferentes alternativos 1 NA, 1 NC</b>	5035 01	10	<b>16,37</b>
<b>Unipolar, dos circuitos diferentes alternativos 2 NA</b>	5035 03	10	<b>17,07</b>
<b>Doble conmutado, 2 circuitos con 6 bornes de conexión: 2 entradas y 2 salidas por entrada NA o NC</b>	5038 08*	10	<b>31,13</b>

5035

\* Con bornes a tornillo

### Tarjetero hotel

Descripción	Referencia	Emb.	Precio (€)
<b>Pulsador, NA</b>	5051 02	10	<b>11,87</b>
<b>Pulsador conmutador</b>	5056 01	10	<b>11,87</b>
<b>Pulsador, NA con contactos auxiliares</b>	5051 03	10	<b>17,75</b>
<b>Pulsador, 1 NA, 1 NC entradas indepen.</b>	5052 01	10	<b>28,79</b>

5051 02

### Pulsador de tirador

Descripción	Referencia	Emb.	Precio (€)
<b>Pulsador conmutador 10A, 250V</b>	3956 19	10	<b>25,68</b>

3956 19

### Pulsador llave para cerradura perfil semicilíndrico

Descripción	Referencia	Emb.	Precio (€)
<b>Pulsador conmutador</b>	3856 20	10	<b>133,42</b>

3856 20

- Con bornes a tornillo
- Añadir cerradura ref. 1818 o 1818 01

## Mecanismos para persianas



3035 20

### Mecanismos para persianas

Descripción	Referencia	Emb.	Precio (€)
<b>Interruptor 10A, 250 V</b>	3035 20	10	<b>16,94</b>

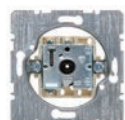

3841

### Mecanismos para persianas rotativos

Descripción	Referencia	Emb.	Precio (€)
<b>Interruptor 10A, 250V</b>	3841 03*	10	<b>29,35</b>
<b>Interruptor bipolar 10A, 250V</b>	3842 03*	10	<b>41,52</b>
<b>Accesorio. Anillo conversión en pulsador</b>	1861	10	<b>3,83</b>

\* Con bornes a tornillo



3822 10

### Mecanismos para persianas de llave

Descripción	Referencia	Emb.	Precio (€)
<b>Interruptor bipolar 10A, 250V para cerradura de perfil semicilíndrico</b>	3822 10*	10	<b>112,49</b>
<b>Interruptor de llave 10A, 250V</b>	3851 03*	10	<b>32,35</b>
<b>Interruptor de llave bipolar 10A, 250V</b>	3852 03*	10	<b>42,87</b>

\* Con bornes a tornillo



5035 20

### Mecanismos pulsadores para persianas

Descripción	Referencia	Emb.	Precio (€)
<b>Pulsador 10A, 250V</b>	5035 20	10	<b>16,11</b>
<b>Pulsador 1 entrada y 4 salidas NA terminal de entrada</b>	5034 04*	10	<b>21,14</b>
<b>Pulsador de llave para cerradura de perfil semicilíndrico</b>	3831 10*	10	<b>104,43</b>
<b>Pulsador bipolar, de llave para cerradura de perfil semicilíndrico</b>	3832 10*	10	<b>112,49</b>

\* Con bornes a tornillo

## Tomas TV / Audio / Video



4573 09

### Altavoces, conectores

Descripción	Referencia	Emb.	Precio (€)
<b>Toma altavoz simple. Blanco polar</b>	4572 09	10	<b>26,35</b>
<b>Toma altavoz simple. Antracita</b>	4572 05	10	<b>26,35</b>
<b>Toma altavoz doble. Blanco polar</b>	4573 09	10	<b>28,67</b>
<b>Toma altavoz doble. Antracita</b>	4573 05	10	<b>28,67</b>

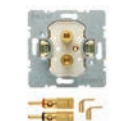

4505 02

<b>2 tomas altavoces estéreo HiFi</b>	4505 02	10	<b>60,80</b>
<b>Conector video</b>	1992	1	<b>32,77</b>
<b>Conector VGA</b>	1994	1	<b>122,86</b>
<b>Conector S-video</b>	1993	1	<b>55,96</b>
<b>Conector Tapa ciega. Blanco polar</b>	1990	1	<b>5,53</b>



4502 10

### Tomas de TV

<b>2 tomas TV-R indep. derivación Única</b>	4502 10	10	<b>20,48</b>
<b>3 tomas TV-R indep. derivación Única</b>	4522 10	10	<b>20,48</b>
<b>4 tomas TV-R indep. derivación Única</b>	4594 10	10	<b>26,77</b>

## Toma Schuko



Descripción	Referencia	Emb.	Precio (€)
<b>Mecanismo SCHUKO</b>	7141 34	10	<b>5,82</b>

- Es necesario añadir las tapas según la serie
- Conexión por tornillo
- Productos certificados VDE y AENOR

## Tomas USB de carga



2602 05

Descripción	Referencia	Emb.	Precio (€)
<b>Antracita, mate</b>	2602 05	1	<b>67,63</b>
<b>Blanco polar, mate</b>	2602 09	1	<b>67,63</b>

- Carga de dispositivos móviles vía cable USB (2 x tipo A)
- 3A

Serie	Referencia	Tapa toma USB
S/B	68 1033 89 82	blanco brillo
	68 1033 89 89	blanco polar brillo
	68 1033 19 09	blanco polar mate
	68 1033 14 04	aluminio
	68 1033 16 06	antracita
Q.x	68 1033 60 82	blanco
	68 1033 60 84	aluminio
	68 1033 60 86	antracita
	68 1033 60 89	blanco polar
K.x	68 1034 70 09	blanco polar
	68 1034 70 06	antracita
	68 1034 70 03	aluminio
	68 1034 70 04	acero
R.x	68 1033 20 89	blanco polar
	68 1033 20 45	negro
Arsys	68 1035 00 02	blanco
	68 1035 00 69	blanco polar
	68 1035 00 01	marrón
	68 1034 00 01	bronce
	68 1034 00 04	acero

## Datos / Telecomunicaciones

Tomas informáticas y teléfono		Referencia	Emb.	Precio (€)
	Descripción			
	<b>Toma telefónica UAE simple 8 cables</b>	4538	10	<b>11,61</b>
4538	<ul style="list-style-type: none"> <li>• Para conectores RJ11, RJ12, RJ45</li> <li>• Cat. 3</li> </ul>			
	Descripción			
	<b>Toma RJ45 simple Categoría 6 clase E (8 polos)</b>	4554 01	10	<b>28,10</b>
4554 01				
	Descripción			
	<b>Toma RJ45 doble Categoría 6 clase E (8/8 polos)</b>	4555 01	10	<b>36,15</b>
4555 01				
	Descripción			
	<b>Toma UAE RJ45 doble Categoría real 6a, clase EA (8/8 pin)</b>	4588	1	<b>51,29</b>
4588				
	Descripción			
	<b>8 polos RJ45 cat. 3</b>	1980	1	<b>23,51</b>
1985	<b>8 polos RJ45 cat. 5e</b>	1984	1	<b>32,14</b>
	<b>8 polos RJ45 cat. 6</b>	1985	1	<b>37,28</b>

Soporte para toma modular jack		Referencia	Emb.	Precio (€)
	Descripción			
	<b>1 toma color rojo</b>	4540 01	10	<b>8,33</b>
4540 01	<b>2 tomas color rojo</b>	4541 01	10	<b>8,33</b>
	<ul style="list-style-type: none"> <li>• Dimensiones aprox: 15,5 x 19,5 mm</li> <li>• Tapas con protector de suciedad</li> <li>• Jack modular: AMP, Asyco, Dätwyler, Dr. Ing. Sieger, EFB Electronic Erni, Hubbell, ICS, Leoni Kerpen, Nexans, Radiall, Rutenbeck, Setec Telegärtner, ZA-Tec, Abitana</li> </ul>			
	Descripción			
	<b>1 toma color blanco</b>	4540 02	10	<b>12,01</b>
4541 05	<b>2 tomas color blanco</b>	4541 05	10	<b>12,01</b>
	<ul style="list-style-type: none"> <li>• Dimensiones aprox: 14,9 x 20,7 mm</li> <li>• Tapas con protector de suciedad</li> <li>• Jack modular: AMP, Brand-Rex, CobiNet, EFB Electronic Tomas AMP serie 110 Connect cat.3, 5, 5e y 6e</li> </ul>			
	Descripción			
	<b>1 toma color verde</b>	4540 04	10	<b>8,33</b>
4541 04	<b>2 tomas color verde</b>	4541 04	10	<b>8,33</b>
	<ul style="list-style-type: none"> <li>• Dimensiones aprox: 17 x 18 mm</li> <li>• Tapas con protector de suciedad</li> <li>• Jack modular: Commscope-Systimax, gigaSpeed, PowerSUM, ref. MGS300BH-X, M1BH-X, MPS100E-X, MGS500-X, MGS400-X, MGS600</li> <li>• Tomas Commscope-Systimax cat. 5 y 6</li> </ul>			
	Descripción			
	<b>2 tomas color marrón</b>	4541 07	10	<b>12,01</b>
4541 07	<ul style="list-style-type: none"> <li>• Dimensiones aprox: 14,9 x 19,5 mm</li> <li>• Tapas con protector de suciedad</li> <li>• Jack modular: Harting, Krone, Reichle&amp;De-Massari, Thomas &amp; Betts</li> <li>• Acopladores fibra óptica: 3M, Krone, mvk</li> <li>• Tomas Krone cat. 5, 5e y 6</li> </ul>			
		Descripción		
<b>2 tomas color naranja</b>		4541 09	10	<b>10,73</b>
4541 09	<ul style="list-style-type: none"> <li>• Dimensiones aprox: 14,9 x 19,5 mm</li> <li>• Tapas con protector de suciedad</li> <li>• Jack modular: BTR, Dätwyler</li> </ul>			
		Descripción		
<b>2 tomas BNC o altavoces</b>		4505	10	<b>14,76</b>
4505				

\*Tabla de tomas RJ45 compatibles en nuestra web: [www.hager.es/documentaciones](http://www.hager.es/documentaciones)

## WLAN

WLAN		Referencia	Emb.	Precio (€)
	Descripción			
	<b>WLAN accesept</b>	4582	1	<b>557,64</b>
4582	<b>WLAN accesept, PoE</b>	4583	1	<b>670,38</b>

## LED señalización blanco

		LED señalización blanco			
	Descripción	Referencia	Emb.	Precio (€)	
2953 89 82	<b>S/B, blanco brillo</b>	2953 89 82	1	<b>102,41</b>	
	<b>S/B, blanco polar brillo</b>	2953 89 89	1	<b>102,41</b>	
	<b>S/B, blanco polar mate</b>	2953 19 09	1	<b>102,41</b>	
	<b>S/B, antracita</b>	2953 16 06	1	<b>108,68</b>	
	<b>S/B, aluminio</b>	2953 14 04	1	<b>116,29</b>	
2953 70 09	<b>Q.x, blanco polar</b>	2953 60 89	1	<b>102,41</b>	
	<b>Q.x, antracita</b>	2953 60 86	1	<b>108,68</b>	
	<b>Q.x, aluminio</b>	2953 60 84	1	<b>108,68</b>	
	<b>K.x, blanco polar</b>	2953 70 09	1	<b>108,47</b>	
	<b>K.x, antracita</b>	2953 70 06	1	<b>108,68</b>	
2953 20 89	<b>K.x, aluminio</b>	2953 70 03	1	<b>116,29</b>	
	<b>K.x, acero inoxidable</b>	2953 70 04	1	<b>116,29</b>	
	<b>R.x, R.classic, blanco polar brillo</b>	2953 20 89	1	<b>108,47</b>	
	<b>R.x, R.classic, negro brillo</b>	2953 20 45	1	<b>108,68</b>	

- Para señalar información o avisos
- Luminosidad ajustable via potenciómetro
- Control via interruptor separado
- Se pueden insertar films con símbolos
- Color blanco frío
- Estética incorporada

## LED señalización rojo/verde

		LED señalización rojo/verde			
	Descripción	Referencia	Emb.	Precio (€)	
2952 89 82	<b>S/B, blanco brillo</b>	2952 89 82	1	<b>116,21</b>	
	<b>S/B, blanco polar brillo</b>	2952 89 89	1	<b>116,21</b>	
	<b>S/B, blanco polar mate</b>	2952 19 09	1	<b>116,21</b>	
	<b>S/B, antracita</b>	2952 16 06	1	<b>122,58</b>	
	<b>S/B, aluminio</b>	2952 14 04	1	<b>130,33</b>	
	<b>Q.x, blanco polar</b>	2952 60 89	1	<b>116,21</b>	
	<b>Q.x, antracita</b>	2952 60 86	1	<b>122,58</b>	
	<b>Q.x, aluminio</b>	2952 60 84	1	<b>122,58</b>	
	<b>K.x, blanco polar</b>	2952 70 09	1	<b>122,40</b>	
	<b>K.x, antracita</b>	2952 70 06	1	<b>122,58</b>	
	<b>K.x, aluminio</b>	2952 70 03	1	<b>130,33</b>	
	<b>K.x, acero inoxidable</b>	2952 70 04	1	<b>130,33</b>	
	<b>R.x, R.classic, blanco polar</b>	2952 20 89	1	<b>122,40</b>	
	<b>R.x, R.classic, negro</b>	2952 20 45	1	<b>122,58</b>	

- Para señalización de control de accesos
- Activación de verde y rojo mediante interruptores separados
- Incluye 2 films de «no molestar/limpiar» y «espere/pase»
- Estética incorporada

## Film para LED señalización

		LED señalización			
	Descripción	Referencia	Emb.	Precio (€)	
1905 80 03	<b>Hombre</b>	1905 80 01	1	<b>10,98</b>	
	<b>Mujer</b>	1905 80 02	1	<b>10,98</b>	
	<b>Silla de ruedas</b>	1905 80 03	1	<b>10,98</b>	
	<b>Escaleras</b>	1905 80 04	1	<b>10,98</b>	
	<b>Ascensor</b>	1905 80 05	1	<b>10,98</b>	
	<b>Redondo, hombre</b>	1905 80 06	1	<b>10,98</b>	
	<b>Redondo, mujer</b>	1905 80 07	1	<b>10,98</b>	
	<b>Redondo, silla de ruedas</b>	1905 80 08	1	<b>10,98</b>	
	<b>Redondo, escaleras</b>	1905 80 09	1	<b>10,98</b>	
	<b>Redondo, ascensor</b>	1905 80 10	1	<b>10,98</b>	

## Film para LED señalización rojo/verde

		Film para LED rojo/verde			
	Descripción	Referencia	Emb.	Precio (€)	
1905 80 11	<b>Símbolo no molestar/limpiar</b>	1905 80 11	1	<b>12,32</b>	
	<b>Símbolo espere/pase</b>	1905 80 12	1	<b>12,32</b>	
	<b>Redondo, símbolo no molestar/limpiar</b>	1905 80 13	1	<b>12,32</b>	
	<b>Redondo, símbolo espere/pase</b>	1905 80 14	1	<b>12,32</b>	

## Señalización

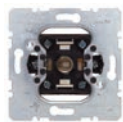

5101 10

### Mecanismo piloto pulsador escalera lámparas E10

Descripción	Referencia	Emb.	Precio (€)
<b>Pulsador NA</b>	5101	10	<b>8,48</b>
<b>Pulsador NA. Contacto separado para señalización</b>	5101 10	10	<b>13,92</b>

- Con bornes a tornillo

### Lámparas E10



1601

Descripción	Referencia	Emb.	Precio (€)
<b>Neón 230V 1,35 mA</b>	1601	100	<b>7,23</b>
<b>LED blanco</b>	1678	10	<b>19,80</b>
<b>LED rojo</b>	1678 01	10	<b>12,83</b>
<b>LED amarillo</b>	1678 02	10	<b>12,83</b>
<b>LED verde</b>	1678 03	10	<b>28,62</b>
<b>LED azul</b>	1678 04	10	<b>18,81</b>



1280

### Tapa transparente para botón luminoso E10

Descripción	Referencia	Emb.	Precio (€)
<b>Transparente</b>	1280	10	<b>3,69</b>
<b>Rojo</b>	1281	10	<b>3,69</b>
<b>Amarillo</b>	1282	10	<b>3,69</b>
<b>Verde</b>	1283	10	<b>3,69</b>



1279 02

### Tapa transparente pulsador luminoso E10 Ø 26,5mm

Descripción	Referencia	Emb.	Precio (€)
<b>Transparente</b>	1279 02	10	<b>5,61</b>
<b>Rojo</b>	1279	10	<b>5,61</b>
<b>Verde</b>	1279 03	10	<b>5,61</b>



5131 02

### Mecanismo piloto para lámparas E14

Descripción	Referencia	Emb.	Precio (€)
<b>Piloto 250V</b>	5131 02	10	<b>14,61</b>



1610 03

### Lámparas E14, 230 V

Descripción	Referencia	Emb.	Precio (€)
<b>Lámpara incandescente para piloto para tapa plana</b>	1610 03	100	<b>11,18</b>
<b>Lámpara incandescente para piloto para tapa alta</b>	1610 13	100	<b>11,18</b>
<b>LED blanco</b>	1679	10	<b>27,25</b>
<b>LED rojo</b>	1679 01	10	<b>17,39</b>
<b>LED amarillo</b>	1679 02	10	<b>17,39</b>
<b>LED verde</b>	1679 03	10	<b>27,26</b>
<b>LED azul</b>	1679 04	10	<b>32,88</b>



1679



1220

### Tapa transparente para botón luminoso E14

Descripción	Referencia	Emb.	Precio (€)
<b>Transparente plana</b>	1220	10	<b>4,86</b>
<b>Transparente alta</b>	1230	10	<b>4,86</b>
<b>Rojo alta</b>	1231	10	<b>4,86</b>
<b>Verde alta</b>	1232	10	<b>4,86</b>

### Salida de cables



4470

Descripción	Referencia	Emb.	Precio (€)
<b>Salida de cables</b>	4470	10	<b>13,40</b>
<b>Salida de cables con espacio adicional</b>	4468	10	<b>11,06</b>

- Diámetro máx. cable 9 mm

### Temporizadores



2041

#### Interruptor temporizado

Descripción	Referencia	Emb.	Precio (€)
<b>Bipolar, 15 min 16AX, 250V</b>	2040	1	<b>141,84</b>
<b>Bipolar, 120 min 16AX, 250V</b>	2041	1	<b>197,67</b>

### Sistemas hospitalarios

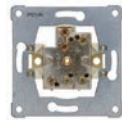

1061

Descripción	Referencia	Emb.	Precio (€)
<b>Mecanismo toma doble equipotencial</b>	1061*	10	<b>53,29</b>
<b>Mecanismo toma equipotencial modular</b>	4604	1	<b>41,05</b>
<b>Clavija para tomas equipotenciales</b>	4605	1	<b>32,82</b>

\* Con bornes a tornillo

### Timbre

Descripción	Referencia	Emb.	Precio (€)
<b>Timbre</b>	BBH03	1	<b>55,00</b>

#### Tapas y marcos intermedios:

Serie	Acabado	Tapa	Marco intermedio
S/B	blanco	1474 02	1109 89 82
	blanco polar, mate	1474 19 09	1109 19 09
	blanco polar, brillo	1474 09	1109 89 89
	aluminio	1474 14 04	1109 14 04
	antracita	1474 16 06	1109 16 06
Q.1/Q.3	blanco	1474 02	1109 60 82
	blanco polar	1474 19 09	1109 60 89
	antracita	1474 16 06	1109 60 86
K.1	aluminio	1474 14 04	1109 60 84
	blanco polar	1474 09	1108 70 09
K.5	antracita	1474 16 06	1108 70 06
	acero	1474 04	1108 70 04
ARSYS	aluminio	1474 14 04	1108 70 03
	blanco	1474 02	1108 00 02
	blanco polar	1474 09	1108 00 69
	acero	1474 04	1108 90 04

Atención: Tapa no disponible para las series berker R.1, R.3 y R.B.

### Accesorios



1818

Descripción	Referencia	Emb.	Precio (€)
<b>Cerradura de perfil semicilíndrico con diferentes cierres</b>	1818	1	<b>46,55</b>

- Incluye 3 llaves

Descripción	Referencia	Emb.	Precio (€)
<b>Cerradura de perfil semicilíndrico con el mismo cierre</b>	1818 01	1	<b>55,96</b>

- Incluye 3 llaves



1913

Descripción	Referencia	Emb.	Precio (€)
<b>Prolongador de garras para mecanismos empotrados</b>	1913	50	<b>1,64</b>
<b>Garra de sustitución</b>	1914	1	<b>1,64</b>



1849

#### Tapas de protección

Descripción	Referencia	Emb.	Precio (€)
<b>Para tomas de corriente e interruptores</b>	1849	10	<b>1,50</b>



1021 12

#### Base autoextinguible para instalación de zócalos

Descripción	Referencia	Emb.	Precio (€)
<b>Base autoex. Zócalos 1 elemento</b>	1021 12	10	<b>6,27</b>
<b>Base autoex. Zócalos 2 elementos</b>	1021 22	10	<b>9,82</b>
<b>Base autoex. Zócalos 3 elementos</b>	1021 32	10	<b>17,34</b>

## Lámparas



1676 01

## Lámpara incandescente con terminal -N

Descripción	Referencia	Emb.	Precio (€)
<b>Marrón 6V, 35 mA</b>	1676	10	<b>8,46</b>
<b>Amarilla 12V, 35 mA</b>	1676 02	10	<b>8,46</b>
<b>Verde 24V, 35 mA</b>	1676 01	10	<b>8,46</b>
<b>Roja 48V, 35 mA</b>	1676 03	10	<b>13,67</b>

- Para interruptores, conmutadores, cruzamientos, interruptores bipolares, mecanismos dobles, pulsadores



1680

## Lámpara LED

Descripción	Referencia	Emb.	Precio (€)
<b>LED negro c/terminal -N, 230V 0,9 mA</b>	1680	1	<b>18,89</b>
<b>LED blanco, 230 V, 1 mA</b>	1686	10	<b>18,89</b>
<b>LED negro, 230 V, 0.4 mA</b>	1686 01	10	<b>18,89</b>
<b>LED azul, 12-48V, 0.2-0.9 mA</b>	1687	10	<b>18,89</b>

- Para mecanismos dobles ref. 3035, 6130 35



1675 04

## Lámpara de Neón

Descripción	Referencia	Emb.	Precio (€)
<b>Carcasa gris terminal -N, 230V, 1mA</b>	1675	10	<b>4,23</b>
<b>Carcasa naranja terminal -N, 230V, 0,4mA</b>	1675 04	10	<b>6,81</b>

- Para interruptores, conmutadores, cruzamientos, interruptores bipolares, mecanismos dobles, pulsadores excepto referencias: 503404, 503808







<b>Carcasa gris, 230V, 0,9 mA, int. 2P 16A</b>	1600 02	10	<b>9,68</b>
--	---------	----	-------------

<b>Carcasa transparente 400V, 0,5 mA, int. 3P</b>	1600	10	<b>11,46</b>
---	------	----	--------------

## Lámparas















Las referencias marcadas con este símbolo son adecuadas para instalaciones IP44 y protección estanca utilizando el kit de sellado.

Unidad LED con Terminal -N	Lámparas incandescentes con terminal - N	Unidad LED con Terminal - N	Lámpara de neón con Terminal - N	Lámpara de neón 230 V~	Lámpara LED	Lámpara de neón
						
1687	1676 6V 1676 02 12V 1676 01 24V 1676 03 48V	1686 1 mA 1686 01 0,4 mA	1675 1 mA 1675 04 0,4 mA	1600 02	1680	1600
12...48V	8...48 V	230 V				400 V

Descripción	Ref.	12...48V	8...48 V	230 V		
<b>Interruptor</b>						
Conmutador	3036 3036 50 3076 25	■	■	■	■	
Cruzamiento	3037	■	■	■	■	
<b>Interruptor bi/tripolar</b>						
Interruptor bipolar 10 AX	3032 3172 05	■	■	■	■	
Interruptor bipolar 16 AX	3032 12					■
Interruptor tripolar 16 AX	3033 03					■
<b>Interruptor / conmutador doble</b>						
Doble interruptor	3035 3035 50	■ <sup>1)</sup>	■ <sup>1)</sup>	■	■ <sup>1)</sup>	■
Doble conmutador	3038 08					■ <sup>1)</sup>
<b>Pulsadores</b>						
Pulsador NA	5031 5031 50	■	■	■	■	
Pulsador, 1 entrada línea y 2 salidas	5036 5076 05	■	■	■	■	
Pulsador unipolar, 3 salidas NA + 2 contactos aux.	5031 01 5071 05	■	■	■	■	
Pulsador unipolar, 2 circuitos diferentes alternativos	5032 03	■	■	■	■	
<b>Pulsador múltiple</b>						
Unipolar 2 contactos NA	5035 5035 03	■ <sup>1)</sup>	■ <sup>1)</sup>	■ <sup>1)</sup>	■ <sup>1)</sup>	
Unipolar 1 NO + 1 Abierto	5035 01	■ <sup>1)</sup>	■ <sup>1)</sup>	■ <sup>1)</sup>	■ <sup>1)</sup>	
Doble conmutado	5038 08					■ <sup>1)</sup>
Pulsador doble persianas	5034 04					■ <sup>1)</sup>
<b>Interruptor de tirador</b>						
Conmutador	3966					
Interruptor bipolar	3962					
Interruptor de emergencia						
Conmutador	3566 05	■	■	■	■	
Interruptor bipolar	3562 05	■	■	■	■	
<b>Combinación IP44</b>						
Interruptor 10A + schuko con tapa	4781 05					
<b>Tarjetero hotel</b>						
Pulsador NA	5051 02	■	■	■	■	
Pulsador conmutador	5056 01	■	■	■	■	
Pulsador, NA con contactos auxiliares	5051 03	■	■	■	■	

<sup>1)</sup> Sólo iluminación individual

### Tabla de selección de reguladores

	Regulador rotativo		
	(R, LED)	Universal (R, L, C, LED)	Universal confort (R, L, C, LED)
Referencia	 2909	 2973	 2961 10
Símbolo			
Apagado suave	■	■	■
Rango			
Mín.	3 W	3 ... 20 W/VA	3 ... 20 W/VA
Máx.	200 W	60 ... 210 W/VA	100 ... 420 W/VA
Tipos de carga			
Incandescentes y halógenas	 ■	■	■
Transformador convencional regulable	 ■	■	■
Transformador electrónico regulable	 ■	■	■
LED regulables	 3 ... 40 W	3 ... 60 W	3 ... 100 W
Bajo consumo regulables	 3 ... 60 W	3 ... 60 W	3 ... 100 W
1-10 V			
DALI			
Extensiones			Extensión de regulador rotativo
<b>Tapas / Teclas / Accesorios</b>			
Tapa central para regulador rotativo Ref. 1137 ..	■	■	■
Tapa para regulador rotativo Ref. 1130 ..			
Teclado 1 fase, Ref. 8514 11 ..			
Teclado 2 fases, Ref. 8514 21 ..			
Teclado radio KNX 1 fase, Ref. 8514 51 ..			
Teclado radio KNX 2 fases, Ref. 8514 61 ..			
Teclado radio KNX 4 fases, Ref. 8564 81 ..			
<b>ACCESORIOS OPCIONALES</b>			
Módulo de compensación LED, Ref. 2913		■	■

1) Máx. 4 reguladores rotativos en paralelo hasta 104 dispositivos DALI. Solo cuando se opera sin una unidad secundaria.

**Regulador rotativo**

1-10 V



2891 10

**DALI**



2997

**DALI con fuente de alimentación**



2998

**Regulador pulsación**

(R, L)



8542 11 00

**Universal 1 fase**



8542 12 00

**Universal 2 fases**



8542 21 00

**Dispositivos DALI**

**DALI/DSI**



8542 17 00



■	■	■	■	■	■	■
Corriente de control 50 mA =	Hasta 64 participantes	26 (104 <sup>(1)</sup> ) participantes	25 W/VA	25 W/VA	35 W/VA por salida	Hasta 64 participantes (pasivos) Hasta 20 participantes (activos)
Corriente de conmutación max. 6 A		Corriente de salida 52 mA	400 W/VA	400 W/VA	300 W/VA por salida	
			■	■	■	
			■	■	■	
				■	■	
				5 ... 70 W	12 ... 54 W	
				13 ... 80 W	15 ... 54 W	
■						
	■	■				■
			Pulsador más cercano	Pulsador más cercano	Pulsador más cercano	
■	■	■				
■	■	■				
			■	■		■
			■	■	■	■
			■	■	■	■
					■	
			■	■		■
			■	■	■	■

## Reguladores rotativos



2873

Descripción	Referencia	Emb.	Precio (€)
<b>Regulador LED rotativo apagado suave pulsación 40-500V</b>	2873	1	<b>85,65</b>

- Para cargas incandescentes, halógenas HV
- Transformadores convencionales y HBV
- LED regulables 230 V. 3...100W
- LV LED con ferrotransformadores 20...100VA
- Corte de fase ascendente



## Mecanismos temporizadores



2948 10

Descripción	Referencia	Emb.	Precio (€)
<b>Mecanismo pulsador con relé temporizador</b>	2948 10	1	<b>148,94</b>

- 230/240V 50/60Hz
- Cargas incandescentes (1500W)
- Halógenas (300W)
- Transformadores electrónicos (1500W)
- Transformadores convencionales (1000VA)

## Regulador 1-10V



2891 10

Descripción	Referencia	Emb.	Precio (€)
<b>Regulador rotativo 1-10V con apagado suave 6A</b>	2891 10	1	<b>55,96</b>



2948

Descripción	Referencia	Emb.	Precio (€)
<b>Mecanismo interruptor horario temporizado</b>	2948	1	<b>153,62</b>

- 230 50/60Hz
- Cargas incandescentes y halógenas (1000W)
- Transformadores electrónicos (750W)
- Transformadores convencionales (500VA)

## Accesorios



7594 10 01

Descripción	Referencia	Emb.	Precio (€)
<b>Mecanismo adaptador para sensores</b>	7594 10 01	10	<b>11,51</b>

- Familia 96



161

Descripción	Referencia	Emb.	Precio (€)
<b>Sensor T° suelo /sensor remoto</b>	161	1	<b>33,18</b>

### Regulador rotativo para LED



2909

Regulador rotativo (R, LED)	2909	1	<b>46,00</b>
-----------------------------	------	---	--------------

### Regulador rotativo universal



2973

Reg. rotativo universal (R, L, C, LED) apagado suave	2973	1	<b>88,90</b>
---	------	---	--------------

### Regulador rotativo universal confort



2961 10

Regulador rotativo universal confort (R, L, C, LED), apagado suave	2961 10	1	<b>134,91</b>
---	---------	---	---------------

Unidad de extensión regulador rotativo universal confort	2962 10	1	<b>85,83</b>
---	---------	---	--------------

### Módulo de compensación LED



2913

Módulo de compensación LED	2913	1	<b>39,89</b>
----------------------------	------	---	--------------

### Regulador rotativo DALI



2998

Reg. rotativo DALI, ajuste blanco, apagado suave	2997	1	<b>76,65</b>
---	------	---	--------------

Regulador rotativo DALI con fuente de alimentación, ajuste blanco, apagado suave	2998	1	<b>153,31</b>
--	------	---	---------------



# berker S.1

berker S.1 es sinónimo de “estándar”, incluso en sus formas. Porque esta gama de interruptores ha fijado los estándares reales de simplicidad, funcionalidad e intemporalidad. Y, porque, gracias a estas cualidades, se ha desarrollado naturalmente para convertirse en una opción estándar para edificios de oficinas y residenciales.



Design  
Award  
Winner  
2000





# berker B.3

Los colores enriquecen la vida, y berker B.3 prácticamente los incorpora en su diseño. Permite encontrar casi cualquier combinación gracias a las múltiples variantes de color para el marco y las teclas.



Design  
Award  
Winner  
2000





# berker B.7

Hay que dar a cada interruptor el marco adecuado: berker B.7 está disponible, además de en variantes con el marco de cristal, en plástico, acero inoxidable y aluminio. En estos materiales, se puede combinar perfectamente con los sensores berker TS y berker B.IQ



## Marcos berker S.1



## Marcos blanco, brillo

Descripción	Referencia	Emb.	Precio (€)
<b>1 elemento</b>	1011 89 82	10	<b>1,27</b>
<b>2 elementos</b>	1012 89 82	10	<b>2,05</b>
<b>3 elementos</b>	1013 89 82	10	<b>3,98</b>
<b>4 elementos</b>	1014 89 82	2	<b>7,32</b>
<b>5 elementos</b>	1015 89 82	2	<b>10,15</b>

• Montaje vertical y horizontal



## Marcos blanco polar

Descripción	Referencia	Emb.	Precio (€)
<b>1 elemento, brillo</b>	1011 89 89	10	<b>1,27</b>
<b>2 elementos, brillo</b>	1012 89 89	10	<b>2,05</b>
<b>3 elementos, brillo</b>	1013 89 89	10	<b>3,98</b>
<b>4 elementos, brillo</b>	1014 89 89	2	<b>7,32</b>
<b>5 elementos, brillo</b>	1015 89 89	2	<b>10,15</b>
<b>1 elemento, mate</b>	1011 99 09	10	<b>1,41</b>
<b>2 elementos, mate</b>	1012 99 09	10	<b>2,18</b>
<b>3 elementos, mate</b>	1013 99 09	10	<b>4,11</b>
<b>4 elementos, mate</b>	1014 99 09	10	<b>7,82</b>
<b>5 elementos, mate</b>	1015 99 09	2	<b>10,92</b>

• Montaje vertical y horizontal



## Marcos aluminio

Descripción	Referencia	Emb.	Precio (€)
<b>1 elemento</b>	1011 99 39	10	<b>2,46</b>
<b>2 elementos</b>	1012 99 39	10	<b>3,80</b>
<b>3 elementos</b>	1013 99 39	10	<b>7,67</b>
<b>4 elementos</b>	1014 99 39	2	<b>12,39</b>
<b>5 elementos</b>	1015 99 39	2	<b>13,71</b>

• Montaje vertical y horizontal



## Marcos antracita

Descripción	Referencia	Emb.	Precio (€)
<b>1 elemento</b>	1011 99 49	10	<b>5,80</b>
<b>2 elementos</b>	1012 99 49	10	<b>8,95</b>
<b>3 elementos</b>	1013 99 49	10	<b>16,85</b>
<b>4 elementos</b>	1014 99 49	2	<b>32,12</b>
<b>5 elementos</b>	1015 99 49	2	<b>44,76</b>

• Montaje vertical y horizontal



## Marcos rojo, brillo

Descripción	Referencia	Emb.	Precio (€)
<b>1 elemento</b>	1011 89 62	10	<b>6,92</b>
<b>2 elementos</b>	1012 89 62	2	<b>12,33</b>
<b>3 elementos</b>	1013 89 62	2	<b>17,72</b>
<b>4 elementos</b>	1014 89 62	2	<b>27,73</b>
<b>5 elementos</b>	1015 89 62	2	<b>38,52</b>

• Montaje vertical y horizontal



## Marcos con portaetiquetas blanco, brillo

Descripción	Referencia	Emb.	Precio (€)
<b>1 elemento</b>	1011 89 12	10	<b>6,55</b>
<b>2 elementos vertical</b>	1012 89 12	10	<b>11,95</b>
<b>3 elementos vertical</b>	1013 89 12	10	<b>18,75</b>
<b>2 elementos horizontal</b>	1022 89 12	10	<b>11,95</b>
<b>3 elementos horizontal</b>	1023 89 12	10	<b>18,75</b>

1011 89 12



## Marcos con portaetiquetas blanco polar

Descripción	Referencia	Emb.	Precio (€)
<b>1 elemento, brillo</b>	1011 89 19	10	<b>6,55</b>
<b>2 elementos vertical, brillo</b>	1012 89 19	10	<b>11,95</b>
<b>3 elementos vertical, brillo</b>	1013 89 19	10	<b>18,75</b>
<b>2 elementos horizontal, brillo</b>	1022 89 19	10	<b>11,95</b>
<b>3 elementos horizontal, brillo</b>	1023 89 19	10	<b>18,75</b>
<b>1 elemento, mate</b>	1011 99 19	10	<b>7,07</b>
<b>2 elementos vertical, mate</b>	1012 99 19	10	<b>12,20</b>
<b>3 elementos vertical, mate</b>	1013 99 19	10	<b>20,29</b>
<b>2 elementos horizontal, mate</b>	1022 99 19	10	<b>13,23</b>
<b>3 elementos horizontal, mate</b>	1023 99 19	10	<b>20,67</b>

• Etiquetas de 6 mm. alto



1011 99 59

## Marcos con portaetiquetas aluminio

Descripción	Referencia	Emb.	Precio (€)
<b>1 elemento</b>	1011 99 59	10	<b>18,82</b>
<b>2 elementos, vertical</b>	1012 99 59	10	<b>31,28</b>
<b>3 elementos, vertical</b>	1013 99 59	10	<b>50,49</b>
<b>2 elementos, horizontal</b>	1022 99 59	10	<b>31,28</b>
<b>3 elementos, horizontal</b>	1023 99 59	10	<b>50,49</b>



1011 99 69

## Marcos con portaetiquetas antracita

Descripción	Referencia	Emb.	Precio (€)
<b>1 elemento</b>	1011 99 69	10	<b>29,55</b>
<b>2 elementos, vertical</b>	1012 99 69	10	<b>51,01</b>
<b>3 elementos, vertical</b>	1013 99 69	10	<b>84,84</b>
<b>2 elementos, horizontal</b>	1022 99 69	10	<b>55,30</b>
<b>3 elementos, horizontal</b>	1023 99 69	10	<b>86,47</b>



1309 99 09

## Marcos para teclados KNX

Descripción	Referencia	Emb.	Precio (€)
<b>Blanco, brillo</b>	1309 89 82	10	<b>3,47</b>
<b>Blanco polar, brillo</b>	1309 89 89	10	<b>3,47</b>
<b>Blanco polar, mate</b>	1309 99 09	10	<b>3,60</b>
<b>Aluminio</b>	1309 99 39	10	<b>21,48</b>
<b>Antracita</b>	1309 99 49	10	<b>21,48</b>

• No es válido para montaje en superficie

• Montaje vertical

## Cajas para montaje en superficie

## Cajas para montaje en superficie



1041 99 09

Descripción	Referencia	Emb.	Precio (€)
<b>1 elemento</b>			
<b>Blanco, brillo</b>	1041 89 82	10	<b>14,25</b>
<b>Blanco polar, brillo</b>	1041 89 89	10	<b>14,25</b>
<b>Blanco polar, mate</b>	1041 99 09	10	<b>17,33</b>
<b>Aluminio</b>	1041 99 39	10	<b>23,28</b>
<b>Antracita</b>	1041 99 49	10	<b>23,28</b>

• Profundidad instalación 37 mm.



1042 99 09

<b>2 elementos</b>			
<b>Blanco, brillo</b>	1042 89 82	5	<b>25,17</b>
<b>Blanco polar, brillo</b>	1042 89 89	5	<b>25,17</b>
<b>Blanco polar, mate</b>	1042 99 09	5	<b>22,98</b>
<b>Aluminio</b>	1042 99 39	5	<b>45,78</b>
<b>Antracita</b>	1042 99 49	5	<b>45,78</b>

• Profundidad instalación 37 mm.



1043 99 09

<b>3 elementos</b>			
<b>Blanco, brillo</b>	1043 89 82	5	<b>39,69</b>
<b>Blanco polar, brillo</b>	1043 89 89	5	<b>39,69</b>
<b>Blanco polar, mate</b>	1043 99 09	5	<b>37,00</b>
<b>Aluminio</b>	1043 99 39	5	<b>67,16</b>
<b>Antracita</b>	1043 99 49	5	<b>67,16</b>

• Profundidad instalación 37 mm.



1130 99 09

## Reguladores rotativos

Descripción	Referencia	Emb.	Precio (€)
<b>Tapa central con int. giratorio para regulador de luz rotativo</b>			
<b>Blanco, brillo</b>	1130 89 82	10	<b>7,35</b>
<b>Blanco polar, brillo</b>	1130 89 89	10	<b>7,35</b>
<b>Blanco polar, mate</b>	1130 99 09	10	<b>11,18</b>
<b>Aluminio</b>	1130 99 39	10	<b>23,60</b>
<b>Antracita</b>	1130 99 49	10	<b>23,60</b>

**Nota:** En instalaciones en paredes de tabique hueco, se recomienda dejar la caja de empotrar enrasada con la pared con el fin de que la instalación de nuestras series de mecanismos se realice de la manera que se han diseñado. Recomendamos el uso de una sierra de corona con avellanador.

## Marcos berker B.3



1011 39 04

### Marcos aluminio / blanco polar

Descripción	Referencia	Emb.	Precio (€)
<b>1 elemento</b>	1011 39 04	10	<b>14,31</b>
<b>2 elementos</b>	1012 39 04	10	<b>23,26</b>
<b>3 elementos</b>	1013 39 04	10	<b>32,11</b>
<b>4 elementos</b>	1014 39 04	2	<b>48,63</b>
<b>5 elementos</b>	1015 39 04	2	<b>60,06</b>

• Montaje vertical y horizontal



1011 30 04

### Marcos aluminio / antracita

Descripción	Referencia	Emb.	Precio (€)
<b>1 elemento</b>	1011 30 04	10	<b>14,31</b>
<b>2 elementos</b>	1012 30 04	10	<b>23,26</b>
<b>3 elementos</b>	1013 30 04	10	<b>32,11</b>
<b>4 elementos</b>	1014 30 04	2	<b>48,63</b>
<b>5 elementos</b>	1015 30 04	2	<b>60,06</b>

• Montaje vertical y horizontal



1013 30 46

### Marcos aluminio, dorado / blanco polar

Descripción	Referencia	Emb.	Precio (€)
<b>1 elemento</b>	1011 30 46	10	<b>20,54</b>
<b>2 elementos</b>	1012 30 46	10	<b>33,39</b>
<b>3 elementos</b>	1013 30 46	10	<b>46,10</b>
<b>4 elementos</b>	1014 30 46	2	<b>69,85</b>
<b>5 elementos</b>	1015 30 46	2	<b>86,29</b>

• Montaje vertical y horizontal



1011 30 16

### Marcos aluminio, dorado / antracita

Descripción	Referencia	Emb.	Precio (€)
<b>1 elemento</b>	1011 30 16	10	<b>20,54</b>
<b>2 elementos</b>	1012 30 16	10	<b>33,39</b>
<b>3 elementos</b>	1013 30 16	10	<b>46,10</b>
<b>4 elementos</b>	1014 30 16	2	<b>69,85</b>
<b>5 elementos</b>	1015 30 16	2	<b>86,29</b>

• Montaje vertical y horizontal



1011 30 25

### Marcos aluminio, negro / blanco polar

Descripción	Referencia	Emb.	Precio (€)
<b>1 elemento</b>	1011 30 25	10	<b>20,54</b>
<b>2 elementos</b>	1012 30 25	10	<b>33,39</b>
<b>3 elementos</b>	1013 30 25	10	<b>46,10</b>
<b>4 elementos</b>	1014 30 25	2	<b>69,85</b>
<b>5 elementos</b>	1015 30 25	2	<b>86,29</b>

• Montaje vertical y horizontal



1011 30 05

### Marcos aluminio, negro / antracita

Descripción	Referencia	Emb.	Precio (€)
<b>1 elemento</b>	1011 30 05	10	<b>20,54</b>
<b>2 elementos</b>	1012 30 05	10	<b>33,39</b>
<b>3 elementos</b>	1013 30 05	10	<b>46,10</b>
<b>4 elementos</b>	1014 30 05	2	<b>69,85</b>
<b>5 elementos</b>	1015 30 05	2	<b>86,29</b>

• Montaje vertical y horizontal



1011 30 21

### Marcos aluminio, marrón / blanco polar

Descripción	Referencia	Emb.	Precio (€)
<b>1 elemento</b>	1011 30 21	10	<b>20,54</b>
<b>2 elementos</b>	1012 30 21	10	<b>33,39</b>
<b>3 elementos</b>	1013 30 21	10	<b>46,10</b>
<b>4 elementos</b>	1014 30 21	2	<b>69,85</b>
<b>5 elementos</b>	1015 30 21	2	<b>86,29</b>

• Montaje vertical y horizontal



1011 30 01

### Marcos aluminio, marrón / antracita

Descripción	Referencia	Emb.	Precio (€)
<b>1 elemento</b>	1011 30 01	10	<b>20,54</b>
<b>2 elementos</b>	1012 30 01	10	<b>33,39</b>
<b>3 elementos</b>	1013 30 01	10	<b>46,10</b>
<b>4 elementos</b>	1014 30 01	2	<b>69,85</b>
<b>5 elementos</b>	1015 30 01	2	<b>86,29</b>

• Montaje vertical y horizontal

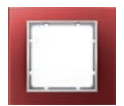

1011 30 22

### Marcos aluminio, rojo / blanco polar

Descripción	Referencia	Emb.	Precio (€)
<b>1 elemento</b>	1011 30 22	10	<b>20,54</b>
<b>2 elementos</b>	1012 30 22	10	<b>33,39</b>
<b>3 elementos</b>	1013 30 22	10	<b>46,10</b>
<b>4 elementos</b>	1014 30 22	2	<b>69,85</b>
<b>5 elementos</b>	1015 30 22	2	<b>86,29</b>

• Montaje vertical y horizontal



1011 30 12

### Marcos aluminio, rojo / antracita

Descripción	Referencia	Emb.	Precio (€)
<b>1 elemento</b>	1011 30 12	10	<b>20,54</b>
<b>2 elementos</b>	1012 30 12	10	<b>33,39</b>
<b>3 elementos</b>	1013 30 12	10	<b>46,10</b>
<b>4 elementos</b>	1014 30 12	2	<b>69,85</b>
<b>5 elementos</b>	1015 30 12	2	<b>86,29</b>

• Montaje vertical y horizontal



1309 30 16

### Marco para teclados KNX

Descripción	Referencia	Emb.	Precio (€)
<b>Aluminio/blanco polar</b>	1309 39 04	1	<b>32,83</b>
<b>Aluminio/antracita</b>	1309 30 04	1	<b>32,83</b>
<b>Aluminio dorado/blanco polar</b>	1309 30 46	1	<b>56,50</b>
<b>Aluminio dorado/antracita</b>	1309 30 16	1	<b>37,25</b>
<b>Aluminio negro/blanco polar</b>	1309 30 25	1	<b>37,25</b>
<b>Aluminio negro/antracita</b>	1309 30 05	1	<b>37,25</b>
<b>Aluminio marrón/blanco polar</b>	1309 30 21	1	<b>37,25</b>
<b>Aluminio marrón/antracita</b>	1309 30 01	1	<b>37,25</b>
<b>Aluminio rojo/blanco polar</b>	1309 30 22	1	<b>37,25</b>
<b>Aluminio rojo/antracita</b>	1309 30 12	1	<b>37,25</b>

• No es válido para montajes en superficie

• Montaje vertical

## Cajas para montaje en superficie



1041 19 09

### Cajas para montaje en superficie

Descripción	Referencia	Emb.	Precio (€)
<b>1 elemento</b>			
<b>Blanco polar, mate</b>	1041 19 09	10	<b>18,34</b>
<b>Antracita</b>	1041 16 06	10	<b>14,64</b>

• Profundidad instalación 37 mm



1042 19 09

<b>2 elementos</b>			
<b>Blanco polar, mate</b>	1042 19 09	5	<b>22,87</b>
<b>Antracita</b>	1042 16 06	5	<b>25,04</b>

• Profundidad instalación 37 mm



1043 19 09

<b>3 elementos</b>			
<b>Blanco polar, mate</b>	1043 19 09	5	<b>36,74</b>
<b>Antracita</b>	1043 16 06	5	<b>39,69</b>

• Profundidad instalación 37 mm

**Nota:** En instalaciones en paredes de tabique hueco, se recomienda dejar la caja de empotrar enrasada con la pared con el fin de que la instalación de nuestras series de mecanismos se realice de la manera que se han diseñado. Recomendamos el uso de una sierra de corona con avellanador.

## Marcos berker B.7



1011 69 19

## Marcos blanco polar, mate

Descripción	Referencia	Emb.	Precio (€)
<b>1 elemento</b>	1011 69 19	10	<b>4,81</b>
<b>2 elementos</b>	1012 69 19	10	<b>7,02</b>
<b>3 elementos</b>	1013 69 19	5	<b>12,08</b>
<b>4 elementos</b>	1014 69 19	1	<b>42,81</b>
<b>5 elementos</b>	1015 69 19	1	<b>67,98</b>



1011 66 26

## Marcos antracita, mate

Descripción	Referencia	Emb.	Precio (€)
<b>1 elemento</b>	1011 66 26	10	<b>7,00</b>
<b>2 elementos</b>	1012 66 26	10	<b>10,69</b>
<b>3 elementos</b>	1013 66 26	5	<b>17,56</b>
<b>4 elementos</b>	1014 66 26	1	<b>50,37</b>
<b>5 elementos</b>	1015 66 26	1	<b>70,50</b>



1011 64 24

## Marcos aluminio, mate

Descripción	Referencia	Emb.	Precio (€)
<b>1 elemento</b>	1011 64 24	10	<b>5,94</b>
<b>2 elementos</b>	1012 64 24	10	<b>9,32</b>
<b>3 elementos</b>	1013 64 24	5	<b>49,07</b>
<b>4 elementos</b>	1014 64 24	1	<b>54,86</b>
<b>5 elementos</b>	1015 64 24	1	<b>86,04</b>



1011 69 14

## Marcos aluminio/blanco polar, mate

Descripción	Referencia	Emb.	Precio (€)
<b>1 elemento</b>	1011 69 14	10	<b>50,37</b>
<b>2 elementos</b>	1012 69 14	5	<b>88,91</b>
<b>3 elementos</b>	1013 69 14	5	<b>101,84</b>
<b>4 elementos</b>	1014 69 14	1	<b>139,27</b>
<b>5 elementos</b>	1015 69 14	1	<b>189,83</b>



1011 69 04

## Marcos aluminio/antracita, mate

Descripción	Referencia	Emb.	Precio (€)
<b>1 elemento</b>	1011 69 04	10	<b>50,37</b>
<b>2 elementos</b>	1012 69 04	5	<b>88,91</b>
<b>3 elementos</b>	1013 69 04	5	<b>98,73</b>
<b>4 elementos</b>	1014 69 04	1	<b>135,02</b>
<b>5 elementos</b>	1015 69 04	1	<b>184,02</b>



1309 69 09

## Marco para teclados KNX

Descripción	Referencia	Emb.	Precio (€)
<b>Blanco polar, mate</b>	1309 69 19	2	<b>36,41</b>
<b>Aluminio, mate</b>	1309 64 24	2	<b>36,41</b>
<b>Antracita</b>	1309 66 26	2	<b>36,41</b>
<b>Aluminio/blanco polar, mate</b>	1309 69 14	2	<b>213,01</b>
<b>Aluminio/antracita, mate</b>	1309 69 04	2	<b>213,01</b>
<b>Acero inoxidable/antracita, mate</b>	1309 36 09	2	<b>152,34</b>
<b>Acero inoxidable/blanco polar, mate</b>	1309 36 06	2	<b>152,34</b>
<b>Cristal, blanco polar</b>	1309 69 09	2	<b>58,14</b>
<b>Cristal, antracita</b>	1309 66 16	2	<b>58,14</b>
<b>Cristal, aluminio</b>	1309 64 14	2	<b>58,14</b>

- No es válido para montajes en superficie
- Montaje vertical

**Nota:** En instalaciones en paredes de tabique hueco, se recomienda dejar la caja de empotrar enrasada con la pared con el fin de que la instalación de nuestras series de mecanismos se realice de la manera que se han diseñado. Recomendamos el uso de una sierra de corona con avellanador.



1011 36 09

## Marcos acero inoxidable/blanco polar, mate

Descripción	Referencia	Emb.	Precio (€)
<b>1 elemento</b>	1011 36 09	10	<b>56,66</b>
<b>2 elementos, vertical</b>	1012 36 09	5	<b>100,02</b>
<b>3 elementos, vertical</b>	1013 36 09	5	<b>167,24</b>
<b>4 elementos, vertical</b>	1014 36 09	1	<b>228,76</b>
<b>5 elementos, vertical</b>	1015 36 09	1	<b>239,19</b>
<b>2 elementos, horizontal</b>	1022 36 09	5	<b>100,02</b>
<b>3 elementos, horizontal</b>	1023 36 09	5	<b>167,24</b>
<b>4 elementos, horizontal</b>	1024 36 09	1	<b>228,76</b>
<b>5 elementos, horizontal</b>	1025 36 09	1	<b>239,19</b>

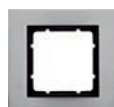

1011 36 06

## Marcos acero inoxidable/antracita, mate

Descripción	Referencia	Emb.	Precio (€)
<b>1 elemento</b>	1011 36 06	10	<b>56,66</b>
<b>2 elementos, vertical</b>	1012 36 06	5	<b>100,02</b>
<b>3 elementos, vertical</b>	1013 36 06	5	<b>167,24</b>
<b>4 elementos, vertical</b>	1014 36 06	1	<b>228,76</b>
<b>5 elementos, vertical</b>	1015 36 06	1	<b>239,19</b>
<b>2 elementos, horizontal</b>	1022 36 06	5	<b>100,02</b>
<b>3 elementos, horizontal</b>	1023 36 06	5	<b>167,24</b>
<b>4 elementos, horizontal</b>	1024 36 06	1	<b>228,76</b>
<b>5 elementos, horizontal</b>	1025 36 06	1	<b>239,19</b>



1011 69 09

## Marcos cristal blanco polar

Descripción	Referencia	Emb.	Precio (€)
<b>1 elemento</b>	1011 69 09	10	<b>29,93</b>
<b>2 elementos</b>	1012 69 09	5	<b>55,85</b>
<b>3 elementos</b>	1013 69 09	5	<b>90,64</b>
<b>4 elementos</b>	1014 69 09	1	<b>123,29</b>
<b>5 elementos</b>	1015 69 09	1	<b>162,71</b>

- Montaje vertical y horizontal
- No válido para montaje en superficie



1011 66 16

## Marcos cristal antracita

Descripción	Referencia	Emb.	Precio (€)
<b>1 elemento</b>	1011 66 16	10	<b>29,93</b>
<b>2 elementos</b>	1012 66 16	5	<b>55,85</b>
<b>3 elementos</b>	1013 66 16	5	<b>90,64</b>
<b>4 elementos</b>	1014 66 16	1	<b>123,29</b>
<b>5 elementos</b>	1015 66 16	1	<b>162,71</b>

- Montaje vertical y horizontal



1011 64 14

## Marcos cristal aluminio

Descripción	Referencia	Emb.	Precio (€)
<b>1 elemento</b>	1011 64 14	10	<b>29,93</b>
<b>2 elementos</b>	1012 64 14	5	<b>55,85</b>
<b>3 elementos</b>	1013 64 14	5	<b>90,64</b>
<b>4 elementos</b>	1014 64 14	1	<b>123,29</b>
<b>5 elementos</b>	1015 64 14	1	<b>162,71</b>

- Montaje vertical y horizontal
- Para resaltar interruptores especiales, tomas de corriente, ...

## Tomas de corriente



1719 89 89

### Tapa para SCHUKO

Descripción	Referencia	Emb.	Precio (€)
<b>Blanco, brillo</b>	1719 89 82	10	<b>4,58</b>
<b>Blanco polar, brillo</b>	1719 89 89	10	<b>4,58</b>
<b>Blanco polar, mate</b>	1719 19 09	10	<b>4,94</b>
<b>Antracita</b>	1719 16 06	10	<b>5,27</b>
<b>Aluminio</b>	1719 14 04	10	<b>6,65</b>
<b>Rojo, mate</b>	1719 19 12	10	<b>5,04</b>
<b>Rojo, brillo</b>	1719 89 12	10	<b>4,67</b>

- Añadir mecanismo ref: 714134
- Con protección infantil

### Toma SCHUKO completa



73 4123 89 89

Descripción	Referencia	Emb.	Precio (€)
<b>Blanco polar, brillo</b>	73 4123 89 89	10	<b>9,72</b>

- Incluye mecanismo ref. 7141 34 y tapa ref. 1719 89 89



4803 89 82

### Toma SCHUKO con USB 2xA

Descripción	Referencia	Emb.	Precio (€)
<b>Blanco, brillo</b>	4803 89 82	1	<b>73,25</b>
<b>Blanco polar, brillo</b>	4803 89 89	1	<b>73,25</b>
<b>Blanco polar, mate</b>	4803 19 09	1	<b>73,25</b>
<b>Antracita</b>	4803 16 06	1	<b>76,29</b>
<b>Aluminio</b>	4803 14 04	1	<b>76,29</b>

- 16A, 230 V~
- USB: 2 x USB tipo A 5V 2,4A
- Espacio reducido para cableado
- Apta para cable flexible



4804 89 82

### Toma SCHUKO con USB A+C

Descripción	Referencia	Emb.	Precio (€)
<b>Blanco, brillo</b>	4804 89 82	1	<b>87,00</b>
<b>Blanco polar, brillo</b>	4804 89 89	1	<b>87,00</b>
<b>Blanco polar, mate</b>	4804 19 09	1	<b>87,00</b>
<b>Antracita</b>	4804 16 06	1	<b>89,59</b>
<b>Aluminio</b>	4804 14 04	1	<b>93,70</b>

- 16A, 230 V~
- USB: USB tipo A + USB tipo C
- Espacio reducido para cableado
- Apta para cable flexible



4149 89 89

### Toma SCHUKO con portaetiquetas

Descripción	Referencia	Emb.	Precio (€)
<b>Blanco, brillo</b>	4149 89 82	10	<b>13,10</b>
<b>Blanco polar, brillo</b>	4149 89 89	10	<b>13,10</b>
<b>Blanco polar, mate</b>	4149 19 09	10	<b>14,13</b>
<b>Antracita</b>	4149 16 06	10	<b>15,67</b>
<b>Aluminio</b>	4149 14 04	10	<b>20,03</b>

- 16A, 250 V~
- Con protección infantil
- Etiquetas de 6 mm alto
- Conexión por tornillo



4109 89 82

### Toma SCHUKO con LED de orientación

Descripción	Referencia	Emb.	Precio (€)
<b>Blanco, brillo</b>	4109 89 82	10	<b>93,63</b>
<b>Blanco polar, brillo</b>	4109 89 89	10	<b>93,53</b>
<b>Blanco polar, mate</b>	4109 19 09	10	<b>93,53</b>
<b>Antracita</b>	4109 16 06	10	<b>93,63</b>
<b>Aluminio</b>	4109 14 04	10	<b>95,82</b>

- 16A, 250 V~
- Con protección infantil
- Conexión por tornillo



4110 89 82

### Toma SCHUKO con LED de control

Descripción	Referencia	Emb.	Precio (€)
<b>Blanco, brillo</b>	4110 89 82	10	<b>26,36</b>
<b>Blanco polar, brillo</b>	4110 89 89	10	<b>26,36</b>
<b>Blanco polar, mate</b>	4110 19 09	10	<b>26,36</b>

- 16A, 250 V~
- Con protección infantil
- Etiquetas de 6 mm alto
- Conexión por tornillo



4142 89 82

### Toma SCHUKO S.1 monobloc

Descripción	Referencia	Emb.	Precio (€)
<b>Blanco, brillo</b>	4142 89 82	10	<b>7,31</b>
<b>Blanco polar, brillo</b>	4142 89 89	10	<b>7,31</b>
<b>Blanco polar, mate</b>	4142 99 09	10	<b>7,31</b>

- Toma SCHUKO completa (marco incluido)

## Teclas

**Tecla**



Descripción	Referencia	Emb.	Precio (€)
<b>Blanco, brillo</b>	1620 89 82	10	<b>1,68</b>
<b>Blanco polar, brillo</b>	1620 89 89	10	<b>1,68</b>
<b>Blanco polar, mate</b>	1620 19 09	10	<b>1,80</b>
<b>Antracita</b>	1620 16 06	10	<b>3,40</b>
<b>Aluminio</b>	1620 14 04	10	<b>7,31</b>

1620 19 09

**Tecla con portaetiquetas**



Descripción	Referencia	Emb.	Precio (€)
<b>Blanco, brillo</b>	1626 89 82	10	<b>7,32</b>
<b>Blanco polar, brillo</b>	1626 89 89	10	<b>7,32</b>
<b>Blanco polar, mate</b>	1626 19 09	10	<b>8,35</b>
<b>Antracita</b>	1626 16 06	10	<b>9,07</b>
<b>Aluminio</b>	1626 14 04	10	<b>12,59</b>

1626 19 09

• Etiquetas de 6 mm alto

**Tecla con 5 indicadores luminosos**



Descripción	Referencia	Emb.	Precio (€)
<b>Blanco, brillo</b>	1621 89 82	10	<b>3,35</b>
<b>Blanco polar, brillo</b>	1621 89 89	10	<b>4,97</b>
<b>Blanco polar, mate</b>	1621 19 09	10	<b>3,35</b>
<b>Antracita</b>	1621 16 06	10	<b>6,91</b>
<b>Aluminio</b>	1621 14 04	10	<b>10,32</b>

1621 19 09

• Indicadores: luz, campana, puerta, neutro transparente, neutro rojo

**Tecla con 5 indicadores luminosos y portaetiquetas**



Descripción	Referencia	Emb.	Precio (€)
<b>Blanco, brillo</b>	1628 89 82	10	<b>8,59</b>
<b>Blanco polar, brillo</b>	1628 89 89	10	<b>8,59</b>
<b>Blanco polar, mate</b>	1628 19 09	10	<b>9,64</b>
<b>Antracita</b>	1628 16 06	10	<b>10,32</b>
<b>Aluminio</b>	1628 14 04	10	<b>13,72</b>

1628 19 09

• Etiquetas de 6 mm alto

**Tecla 5 indicadores luminosos y portaetiq. grande**



Descripción	Referencia	Emb.	Precio (€)
<b>Blanco, brillo</b>	1696 89 82	10	<b>11,20</b>
<b>Blanco polar, brillo</b>	1696 89 89	10	<b>11,15</b>
<b>Blanco polar, mate</b>	1696 19 09	10	<b>10,68</b>
<b>Antracita</b>	1696 16 06	10	<b>11,71</b>
<b>Aluminio</b>	1696 14 04	10	<b>15,53</b>

1696 19 09

• Portaetiquetas 50,8 x 25,5 mm  
• Etiquetas de 12 mm alto

**Tecla con "0"**



Descripción	Referencia	Emb.	Precio (€)
<b>Blanco, brillo</b>	1622 89 82	10	<b>5,27</b>
<b>Blanco polar, brillo</b>	1622 89 89	10	<b>5,27</b>
<b>Blanco polar, mate</b>	1622 19 09	10	<b>4,48</b>
<b>Antracita</b>	1622 16 06	10	<b>6,29</b>
<b>Aluminio</b>	1622 14 04	10	<b>8,44</b>

1622 19 09

**Tecla con "0" e indicador luminoso**



Descripción	Referencia	Emb.	Precio (€)
<b>Blanco, brillo</b>	1624 89 82	10	<b>6,55</b>
<b>Blanco polar, brillo</b>	1624 89 89	10	<b>6,55</b>
<b>Blanco polar, mate</b>	1624 19 09	10	<b>9,00</b>
<b>Antracita</b>	1624 16 06	10	<b>7,31</b>
<b>Aluminio</b>	1624 14 04	10	<b>10,45</b>

1624 19 09



1150 89 82

## Interruptor rotativo

Descripción	Referencia	Emb.	Precio (€)
<b>Blanco, brillo</b>	1150 89 82	1	<b>13,36</b>
<b>Blanco polar, brillo</b>	1150 89 89	1	<b>13,36</b>
<b>Blanco polar, mate</b>	1150 19 09	1	<b>13,88</b>
<b>Antracita</b>	1150 16 06	1	<b>19,64</b>
<b>Aluminio</b>	1150 14 04	1	<b>20,25</b>



1623 19 09

## Tecla doble

Descripción	Referencia	Emb.	Precio (€)
<b>Blanco, brillo</b>	1623 89 82	10	<b>3,09</b>
<b>Blanco polar, brillo</b>	1623 89 89	10	<b>3,09</b>
<b>Blanco polar, mate</b>	1623 19 09	10	<b>3,20</b>
<b>Antracita</b>	1623 16 06	10	<b>6,66</b>
<b>Aluminio</b>	1623 14 04	10	<b>10,20</b>



1627 19 09

## Tecla doble con indicador luminoso

Descripción	Referencia	Emb.	Precio (€)
<b>Blanco, brillo</b>	1627 89 82	10	<b>9,64</b>
<b>Blanco polar, brillo</b>	1627 89 89	10	<b>9,64</b>
<b>Blanco polar, mate</b>	1627 19 09	10	<b>10,67</b>
<b>Antracita</b>	1627 16 06	10	<b>8,82</b>
<b>Aluminio</b>	1627 14 04	10	<b>12,47</b>



1665 89 82

## Tecla para mecanismo triple ON/OFF

Descripción	Referencia	Emb.	Precio (€)
<b>Blanco, brillo</b>	1665 89 82	10	<b>10,51</b>
<b>Blanco polar, brillo</b>	1665 89 89	10	<b>10,51</b>
<b>Blanco polar, mate</b>	1665 19 09	10	<b>11,95</b>
<b>Antracita</b>	1665 16 06	10	<b>14,86</b>
<b>Aluminio</b>	1665 14 04	10	<b>17,50</b>

• Teclado triple ref. 6330 23



1625 19 09

## Tecla doble persiana

Descripción	Referencia	Emb.	Precio (€)
<b>Blanco, brillo</b>	1625 89 82	10	<b>6,66</b>
<b>Blanco polar, brillo</b>	1625 89 89	10	<b>6,66</b>
<b>Blanco polar, mate</b>	1625 19 09	10	<b>7,46</b>
<b>Antracita</b>	1625 16 06	10	<b>11,59</b>
<b>Aluminio</b>	1625 14 04	10	<b>14,86</b>

## Teclas con tornillos



1570 19 09

## Tecla simple con tornillos

Descripción	Referencia	Emb.	Precio (€)
<b>Blanco polar, mate</b>	1570 19 09	10	<b>24,81</b>
<b>Antracita</b>	1570 16 06	10	<b>27,89</b>
<b>Aluminio</b>	1570 14 04	10	<b>29,58</b>



1572 19 09

## Tecla simple con tornillos e indicador luminoso

Descripción	Referencia	Emb.	Precio (€)
<b>Blanco polar, mate</b>	1572 19 09	10	<b>29,94</b>
<b>Antracita</b>	1572 16 06	10	<b>30,19</b>
<b>Aluminio</b>	1572 14 04	10	<b>32,00</b>



1573 19 09

## Tecla simple con tornillos y "0"

Descripción	Referencia	Emb.	Precio (€)
<b>Blanco polar, mate</b>	1573 19 09	10	<b>26,83</b>
<b>Antracita</b>	1573 16 06	10	<b>27,59</b>
<b>Aluminio</b>	1573 14 04	10	<b>29,09</b>



Descripción	Referencia	Emb.	Precio (€)
<b>Blanco polar, mate</b>	1577 19 09	10	<b>29,04</b>
<b>Antracita</b>	1577 16 06	10	<b>29,78</b>
<b>Aluminio</b>	1577 14 04	10	<b>30,94</b>

1577 19 09



Descripción	Referencia	Emb.	Precio (€)
<b>Blanco polar, mate</b>	1571 19 09	10	<b>18,74</b>
<b>Antracita</b>	1571 16 06	10	<b>18,55</b>
<b>Aluminio</b>	1571 14 04	10	<b>17,30</b>

1571 19 09

## Teclas sin barreras



Descripción	Referencia	Emb.	Precio (€)
<b>Blanco polar, mate</b>	1661 19 49	10	<b>12,96</b>

1661 19 49

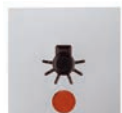

Descripción	Referencia	Emb.	Precio (€)
<b>Blanco polar, mate</b>	1651 19 49	10	<b>11,52</b>

1651 19 49

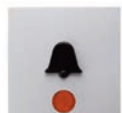

Descripción	Referencia	Emb.	Precio (€)
<b>Blanco polar, mate</b>	1651 19 59	10	<b>11,52</b>

1651 19 59



Descripción	Referencia	Emb.	Precio (€)
<b>Blanco polar, mate</b>	1651 19 69	10	<b>11,52</b>

- Sin barreras basado en DIN 18025

1651 19 69

## Tapas



Descripción	Referencia	Emb.	Precio (€)
<b>Blanco, brillo</b>	1640 89 82	10	<b>11,38</b>
<b>Blanco polar, brillo</b>	1640 89 89	10	<b>11,38</b>
<b>Blanco polar, mate</b>	1640 19 09	10	<b>12,71</b>
<b>Antracita</b>	1640 16 06	10	<b>38,49</b>
<b>Aluminio</b>	1640 14 04	10	<b>70,56</b>

1640 19 09

• Mecanismo ref.: 5051 02, 5051 03, 5052 01, 5056 01



Descripción	Referencia	Emb.	Precio (€)
<b>Blanco, brillo</b>	1146 89 82	10	<b>6,29</b>
<b>Blanco polar, brillo</b>	1146 89 89	10	<b>6,29</b>
<b>Blanco polar, mate</b>	1146 19 09	10	<b>9,11</b>
<b>Antracita</b>	1146 16 06	10	<b>10,40</b>
<b>Aluminio</b>	1146 14 04	10	<b>14,52</b>

1146 19 09



Descripción	Referencia	Emb.	Precio (€)
<b>Blanco, brillo</b>	1080 89 82 00	1	<b>10,49</b>
<b>Blanco polar, brillo</b>	1080 89 89 00	1	<b>10,78</b>
<b>Blanco polar, mate</b>	1080 19 09 00	1	<b>12,96</b>
<b>Antracita</b>	1080 16 06 00	1	<b>14,27</b>
<b>Aluminio</b>	1080 14 04 00	1	<b>20,43</b>

1080 19 09 00



Descripción	Referencia	Emb.	Precio (€)
<b>Sin posición 0</b>			
<b>Blanco, brillo</b>	1084 89 82 00	1	<b>10,49</b>
<b>Blanco polar, brillo</b>	1084 89 89 00	1	<b>11,01</b>
<b>Blanco polar, mate</b>	1084 19 09 00	1	<b>12,18</b>
<b>Antracita</b>	1084 16 06 00	1	<b>14,27</b>
<b>Aluminio</b>	1084 14 04 00	1	<b>20,43</b>
<b>Con posición neutra</b>			
<b>Blanco, brillo</b>	1096 89 82 00	1	<b>10,59</b>
<b>Blanco polar, brillo</b>	1096 89 89 00	1	<b>10,59</b>
<b>Blanco polar, mate</b>	1096 19 09 00	1	<b>12,18</b>
<b>Antracita</b>	1096 16 06 00	1	<b>14,27</b>
<b>Aluminio</b>	1096 14 04 00	1	<b>20,43</b>

1084 19 09 00



Descripción	Referencia	Emb.	Precio (€)
<b>LLlave extraible en posición media</b>			
<b>Blanco, brillo</b>	1081 89 82 00	1	<b>59,97</b>
<b>Blanco polar, brillo</b>	1081 89 89 00	1	<b>59,97</b>
<b>Blanco polar, mate</b>	1081 19 09 00	1	<b>92,69</b>
<b>Antracita</b>	1081 16 06 00	1	<b>94,78</b>
<b>Aluminio</b>	1081 14 04 00	1	<b>94,67</b>

1081 19 09 00



Descripción	Referencia	Emb.	Precio (€)
<b>Llave extraible en las 3 posiciones</b>			
<b>Blanco, brillo</b>	1082 89 82 00	1	<b>60,11</b>
<b>Blanco polar, brillo</b>	1082 89 89 00	1	<b>60,11</b>
<b>Blanco polar, mate</b>	1082 19 09 00	1	<b>92,69</b>

- Función bloqueo presión

1082 89 82 00



Descripción	Referencia	Emb.	Precio (€)
<b>Blanco, brillo</b>	1083 89 82 00	1	<b>60,11</b>
<b>Blanco polar, brillo</b>	1083 89 89 00	1	<b>60,11</b>
<b>Blanco polar, mate</b>	1083 19 09 00	1	<b>92,69</b>

- Función sólo pulsador
- Llave extraible en posición media

1083 19 09 00



Descripción	Referencia	Emb.	Precio (€)
<b>Blanco, brillo</b>	1506 89 82	10	<b>13,10</b>
<b>Blanco polar, brillo</b>	1506 89 89	10	<b>13,10</b>
<b>Blanco polar, mate</b>	1506 19 09	10	<b>21,43</b>
<b>Antracita</b>	1506 16 06	10	<b>23,88</b>
<b>Aluminio</b>	1506 14 04	10	<b>33,00</b>

1506 19 09

• Con símbolo persiana



<b>Blanco, brillo</b>	1507 89 82	10	<b>13,10</b>
<b>Blanco polar, brillo</b>	1507 89 89	10	<b>13,10</b>
<b>Blanco polar, mate</b>	1507 19 09	10	<b>21,43</b>
<b>Antracita</b>	1507 16 06	10	<b>23,88</b>
<b>Aluminio</b>	1507 14 04	10	<b>33,00</b>

1507 19 09

• Sin símbolo

## Señalización



Descripción	Referencia	Emb.	Precio (€)
<b>Blanco, brillo</b>	5101 89 82	10	<b>32,11</b>
<b>Blanco polar, brillo</b>	5101 89 89	10	<b>32,11</b>
<b>Blanco polar, mate</b>	5101 99 09	10	<b>32,11</b>

5101 99 09

• Marco incluido

## Tapas ciegas



1009 19 09

### Tapas ciegas con tapa central

Descripción	Referencia	Emb.	Precio (€)
<b>Sin garras</b>			
<b>Blanco, brillo</b>	1009 89 82	20	<b>10,40</b>
<b>Blanco polar, brillo</b>	1009 89 89	20	<b>10,40</b>
<b>Blanco polar, mate</b>	1009 19 09	20	<b>10,78</b>
<b>Antracita</b>	1009 16 06	20	<b>13,97</b>
<b>Aluminio</b>	1009 14 04	20	<b>17,88</b>

### Con base y garras

Descripción	Referencia	Emb.	Precio (€)
<b>Blanco, brillo</b>	67 1009 89 82	10	<b>10,67</b>
<b>Blanco polar, brillo</b>	67 1009 89 89	10	<b>10,67</b>
<b>Blanco polar, mate</b>	67 1009 19 09	10	<b>10,78</b>
<b>Antracita</b>	67 1009 16 06	10	<b>13,97</b>
<b>Aluminio</b>	67 1009 14 04	10	<b>17,88</b>



1009 19 19

### Tapas ciegas atornilladas

Descripción	Referencia	Emb.	Precio (€)
<b>Blanco, brillo</b>	1009 89 12	20	<b>13,10</b>
<b>Blanco polar, brillo</b>	1009 89 19	20	<b>13,10</b>
<b>Blanco polar, mate</b>	1009 19 19	20	<b>14,52</b>
<b>Antracita</b>	1009 16 16	20	<b>18,23</b>
<b>Aluminio</b>	1009 14 14	20	<b>22,06</b>

• Sin garras

## Señalización



1124 19 09

### Tapa central para piloto / pulsador y lámpara E10

Descripción	Referencia	Emb.	Precio (€)
<b>Blanco, brillo</b>	1124 89 82	10	<b>2,84</b>
<b>Blanco polar, brillo</b>	1124 89 89	10	<b>2,84</b>
<b>Blanco polar, mate</b>	1124 19 09	10	<b>7,32</b>
<b>Antracita</b>	1124 16 06	10	<b>8,86</b>
<b>Aluminio</b>	1124 14 04	10	<b>12,72</b>



1198 19 09

### Tapa central para piloto lámpara E14

Descripción	Referencia	Emb.	Precio (€)
<b>Blanco, brillo</b>	1198 89 82	10	<b>4,75</b>
<b>Blanco polar, brillo</b>	1198 89 89	10	<b>4,75</b>
<b>Blanco polar, mate</b>	1198 19 09	10	<b>7,59</b>
<b>Antracita</b>	1198 16 06	10	<b>8,59</b>
<b>Aluminio</b>	1198 14 04	10	<b>12,72</b>

## Temporizadores



1632 19 09

### Tapa c/mando rotativo para temporizador mecánico

Descripción	Referencia	Emb.	Precio (€)
<b>Máximo 15 minutos</b>			
<b>Blanco, brillo</b>	1632 89 82	1	<b>11,16</b>
<b>Blanco polar, brillo</b>	1632 89 89	1	<b>11,16</b>
<b>Blanco polar, mate</b>	1632 19 09	1	<b>19,39</b>
<b>Antracita</b>	1632 16 06	1	<b>22,23</b>
<b>Aluminio</b>	1632 14 04	1	<b>31,07</b>
<b>Máximo 120 minutos</b>			
<b>Blanco, brillo</b>	1633 89 82	1	<b>11,16</b>
<b>Blanco polar, brillo</b>	1633 89 89	1	<b>11,16</b>
<b>Blanco polar, mate</b>	1633 19 09	1	<b>19,39</b>
<b>Antracita</b>	1633 16 06	1	<b>22,23</b>
<b>Aluminio</b>	1633 14 04	1	<b>31,07</b>



1674 19 09

### Tapa con pulsador para relé temporizador

Descripción	Referencia	Emb.	Precio (€)
<b>Blanco, brillo</b>	1674 89 82	10	<b>13,41</b>
<b>Blanco polar, brillo</b>	1674 89 89	10	<b>13,41</b>
<b>Blanco polar, mate</b>	1674 19 09	10	<b>13,41</b>
<b>Antracita</b>	1674 16 06	10	<b>19,89</b>
<b>Aluminio</b>	1674 14 04	10	<b>29,26</b>

## Llamada emergencia berker S.1 (Marcos incluidos)



5200 89 82

### Kit de llamada de emergencia

Descripción	Referencia	Emb.	Precio (€)
<b>Blanco, brillo</b>	5200 89 82	1	<b>291,87</b>
<b>Blanco polar, brillo</b>	5200 89 89	1	<b>291,87</b>
<b>Blanco polar, mate</b>	5200 99 09	1	<b>291,87</b>



5201 89 82

### Pulsador de confirmación

Descripción	Referencia	Emb.	Precio (€)
<b>Blanco, brillo</b>	5201 89 82	1	<b>37,31</b>
<b>Blanco polar, brillo</b>	5201 89 89	1	<b>37,31</b>
<b>Blanco polar, mate</b>	5201 99 09	1	<b>37,31</b>



5202 89 82

### Pulsador de tirador

Descripción	Referencia	Emb.	Precio (€)
<b>Blanco, brillo</b>	5202 89 82	1	<b>37,31</b>
<b>Blanco polar, brillo</b>	5202 89 89	1	<b>37,31</b>
<b>Blanco polar, mate</b>	5202 99 09	1	<b>37,31</b>



5203 89 82

### Indicador luminoso

Descripción	Referencia	Emb.	Precio (€)
<b>Blanco, brillo</b>	5203 89 82	1	<b>153,62</b>
<b>Blanco polar, brillo</b>	5203 89 89	1	<b>153,62</b>
<b>Blanco polar, mate</b>	5203 99 09	1	<b>153,62</b>



5204 89 82

### Fuente de alimentación

Descripción	Referencia	Emb.	Precio (€)
<b>Blanco, brillo</b>	5204 89 82	1	<b>103,14</b>
<b>Blanco polar, brillo</b>	5204 89 89	1	<b>103,14</b>
<b>Blanco polar, mate</b>	5204 99 09	1	<b>103,14</b>



5205 89 82

### Pulsador presencia/pausa

Descripción	Referencia	Emb.	Precio (€)
<b>Blanco, brillo</b>	5205 89 82	1	<b>102,60</b>
<b>Blanco polar, brillo</b>	5205 89 89	1	<b>102,60</b>
<b>Blanco polar, mate</b>	5205 99 09	1	<b>102,60</b>



5206 89 82

### Pulsador de llamada

Descripción	Referencia	Emb.	Precio (€)
<b>Blanco, brillo</b>	5206 89 82	1	<b>37,31</b>
<b>Blanco polar, brillo</b>	5206 89 89	1	<b>37,31</b>
<b>Blanco polar, mate</b>	5206 99 09	1	<b>37,31</b>

## Tapas control velocidad



1137 19 29

### Tapa central con mando para control velocidad

Descripción	Referencia	Emb.	Precio (€)
<b>Blanco, brillo</b>	1137 89 22	10	<b>13,41</b>
<b>Blanco polar, brillo</b>	1137 89 29	10	<b>13,41</b>
<b>Blanco polar, mate</b>	1137 19 29	10	<b>13,41</b>
<b>Antracita</b>	1137 16 26	10	<b>19,89</b>
<b>Aluminio</b>	1137 14 24	10	<b>29,26</b>

## Tapa regulador rotativo



1137 19 09

### Tapa central c/mando rotativo para regulad. rotativo

Descripción	Referencia	Emb.	Precio (€)
<b>Blanco, brillo</b>	1137 89 82	10	<b>7,35</b>
<b>Blanco polar, brillo</b>	1137 89 89	10	<b>7,35</b>
<b>Blanco polar, mate</b>	1137 19 09	10	<b>11,18</b>
<b>Antracita</b>	1137 16 06	10	<b>17,66</b>
<b>Aluminio</b>	1137 14 04	10	<b>27,12</b>

## Termostatos



2030 19 09

### Termostato

Descripción	Referencia	Emb.	Precio (€)
<b>Blanco, brillo</b>	2030 89 82	1	<b>104,02</b>
<b>Blanco polar, brillo</b>	2030 89 89	1	<b>104,02</b>
<b>Blanco polar, mate</b>	2030 19 09	1	<b>118,13</b>
<b>Antracita</b>	2030 16 06	1	<b>125,84</b>
<b>Aluminio</b>	2030 14 04	1	<b>130,97</b>

- 250V, 10 (4)A CA



2026 19 09

### Termostato con conmutador

Descripción	Referencia	Emb.	Precio (€)
<b>Blanco, brillo</b>	2026 89 82	1	<b>104,02</b>
<b>Blanco polar, brillo</b>	2026 89 89	1	<b>104,02</b>
<b>Blanco polar, mate</b>	2026 19 09	1	<b>118,13</b>
<b>Antracita</b>	2026 16 06	1	<b>125,84</b>
<b>Aluminio</b>	2026 14 04	1	<b>130,97</b>

- 230 V
- calefacción: 10 (4) A
- refrigeración: 5 (2) A



2034 19 09

### Termostato de suelo radiante

Descripción	Referencia	Emb.	Precio (€)
<b>Blanco, brillo</b>	2034 89 82	1	<b>357,54</b>
<b>Blanco polar, brillo</b>	2034 89 89	1	<b>357,54</b>
<b>Blanco polar, mate</b>	2034 19 09	1	<b>357,54</b>
<b>Antracita</b>	2034 16 06	1	<b>365,04</b>
<b>Aluminio</b>	2034 14 04	1	<b>369,95</b>



7594 04 09

### Tapa sensor

Descripción	Referencia	Emb.	Precio (€)
<b>Blanco, brillo</b>	7594 04 02	1	<b>4,46</b>
<b>Blanco polar, brillo</b>	7594 04 09	1	<b>4,46</b>
<b>Blanco polar, mate</b>	7594 04 89	1	<b>4,46</b>
<b>Antracita</b>	7594 04 85	1	<b>11,49</b>
<b>Aluminio</b>	7594 04 83	1	<b>13,83</b>
<b>Acero</b>	7594 04 03	1	<b>17,34</b>
<b>Bronce</b>	7594 04 04	1	<b>17,34</b>

- Utilizar sólo con marcos intermedios de la serie correspondiente
- Mecanismo ref: 7594 10 01
- Familia 96

## Tarjetero hotel electrónico



1640 89 99

### Tarjetero hotel electrónico

Descripción	Referencia	Emb.	Precio (€)
<b>Blanco, brillo</b>	1640 89 92	1	<b>91,28</b>
<b>Blanco polar, brillo</b>	1640 89 99	1	<b>91,28</b>
<b>Blanco polar, mate</b>	1640 99 09	1	<b>91,28</b>
<b>Antracita</b>	1640 99 06	1	<b>91,91</b>
<b>Aluminio</b>	1640 89 84	1	<b>93,12</b>

## TV / Audio / Video



33 1532 19 09

### Toma 3 x Cinch/S-Video

Descripción	Referencia	Emb.	Precio (€)
<b>Blanco, brillo</b>	33 1532 89 82	10	<b>157,97</b>
<b>Blanco polar, brillo</b>	33 1532 89 89	10	<b>157,97</b>
<b>Blanco polar, mate</b>	33 1532 19 09	10	<b>157,97</b>
<b>Antracita</b>	33 1532 16 06	10	<b>172,65</b>
<b>Aluminio</b>	33 1532 14 04	10	<b>177,47</b>



33 1540 89 89

### Toma VGA

Descripción	Referencia	Emb.	Precio (€)
<b>Blanco, brillo</b>	33 1540 89 82	10	<b>79,09</b>
<b>Blanco polar, brillo</b>	33 1540 89 89	10	<b>79,09</b>
<b>Blanco polar, mate</b>	33 1540 19 09	10	<b>79,09</b>
<b>Antracita</b>	33 1540 16 06	10	<b>88,22</b>
<b>Aluminio</b>	33 1540 14 04	10	<b>93,06</b>



33 1541 89 89

### Toma VGA con terminales a tornillo y mordaza

Descripción	Referencia	Emb.	Precio (€)
<b>Blanco, brillo</b>	33 1541 89 82	10	<b>79,09</b>
<b>Blanco polar, brillo</b>	33 1541 89 89	10	<b>79,09</b>
<b>Blanco polar, mate</b>	33 1541 19 09	10	<b>79,09</b>
<b>Antracita</b>	33 1541 16 06	10	<b>88,22</b>
<b>Aluminio</b>	33 1541 14 04	10	<b>93,06</b>



33 1539 19 09

### Toma USB / audio 3,5 mm.

Descripción	Referencia	Emb.	Precio (€)
<b>Blanco, brillo</b>	33 1539 89 82	10	<b>103,87</b>
<b>Blanco polar, mate</b>	33 1539 19 09	10	<b>103,87</b>



33 1542 89 89

### Toma alta definición

Descripción	Referencia	Emb.	Precio (€)
<b>Blanco, brillo</b>	33 1542 89 82	1	<b>180,58</b>
<b>Blanco polar, brillo</b>	33 1542 89 89	1	<b>180,58</b>
<b>Blanco polar, mate</b>	33 1542 19 09	10	<b>180,58</b>
<b>Antracita</b>	33 1542 16 06	10	<b>196,77</b>
<b>Aluminio</b>	33 1542 14 04	10	<b>201,58</b>



33 1543 89 89

### Toma alta definición con conexión 90°

Descripción	Referencia	Emb.	Precio (€)
<b>Blanco, brillo</b>	33 1543 89 82	10	<b>180,58</b>
<b>Blanco polar, brillo</b>	33 1543 89 89	10	<b>180,58</b>
<b>Blanco polar, mate</b>	33 1543 19 09	10	<b>180,58</b>
<b>Antracita</b>	33 1543 16 06	10	<b>196,77</b>
<b>Aluminio</b>	33 1543 14 04	10	<b>201,58</b>



1412 19 09

### Tapa central para conectores redondos XLR serie D

Descripción	Referencia	Emb.	Precio (€)
<b>Blanco, brillo</b>	1412 02	10	<b>10,03</b>
<b>Blanco polar, brillo</b>	1412 09	10	<b>10,03</b>
<b>Blanco polar, mate</b>	1412 19 09	10	<b>11,16</b>
<b>Antracita</b>	1412 16 06	10	<b>13,99</b>
<b>Aluminio</b>	1412 14 04	10	<b>20,54</b>



1196 19 09

### Tapa central para toma altavoz y conector mini

Descripción	Referencia	Emb.	Precio (€)
<b>Blanco, brillo</b>	1196 89 82	10	<b>5,91</b>
<b>Blanco polar, brillo</b>	1196 89 89	10	<b>5,91</b>
<b>Blanco polar, mate</b>	1196 19 09	10	<b>7,82</b>
<b>Antracita</b>	1196 16 06	10	<b>9,40</b>
<b>Aluminio</b>	1196 14 04	10	<b>13,23</b>



#### Tapa central para toma TV 1 salida

Descripción	Referencia	Emb.	Precio (€)
<b>Blanco, brillo</b>	1499 89 82	10	<b>5,78</b>
<b>Blanco polar, brillo</b>	1499 89 89	10	<b>5,78</b>
<b>Blanco polar, mate</b>	1499 19 09	10	<b>6,55</b>
<b>Antracita</b>	1499 16 06	10	<b>8,09</b>
<b>Aluminio</b>	1499 14 04	10	<b>11,07</b>

1499 89 82



#### Tapa central para toma TV 2 ó 3 salidas

Descripción	Referencia	Emb.	Precio (€)
<b>Blanco, brillo</b>	1203 89 82	10	<b>2,49</b>
<b>Blanco polar, brillo</b>	1203 89 89	10	<b>2,49</b>
<b>Blanco polar, mate</b>	1203 19 09	10	<b>2,49</b>
<b>Antracita</b>	1203 16 06	10	<b>9,70</b>
<b>Aluminio</b>	1203 14 04	10	<b>13,72</b>

1203 19 09



#### Tapa central para toma TV 4 salidas

Descripción	Referencia	Emb.	Precio (€)
<b>Blanco, brillo</b>	1484 02	10	<b>5,12</b>
<b>Blanco polar, brillo</b>	1484 09	10	<b>5,12</b>
<b>Blanco polar, mate</b>	1484 19 09	10	<b>5,02</b>
<b>Antracita</b>	1484 16 06	10	<b>8,35</b>
<b>Aluminio</b>	1484 14 04	10	<b>12,59</b>
<b>Marrón</b>	1484 01	10	<b>11,04</b>
<b>Acero</b>	1484 04	10	<b>13,36</b>
<b>Bronce</b>	1484 11	10	<b>13,36</b>

1484 09

- Utilizar sólo con marcos intermedios de la serie correspondiente
- Tomas TV de Ankaró, Astro, Axing, Delta, Schwaiger



#### Tapa central para toma TV 4 salidas con tornillo

Descripción	Referencia	Emb.	Precio (€)
<b>Blanco, brillo</b>	1483 02	10	<b>4,75</b>
<b>Blanco polar, brillo</b>	1483 09	10	<b>4,75</b>
<b>Blanco polar, mate</b>	1483 19 09	10	<b>5,12</b>
<b>Antracita</b>	1483 16 06	10	<b>8,35</b>
<b>Aluminio</b>	1483 14 04	10	<b>12,59</b>
<b>Marrón</b>	1483 01	10	<b>11,16</b>
<b>Acero</b>	1483 04	10	<b>16,57</b>
<b>Bronce</b>	1483 11	10	<b>13,36</b>

1483 09

- Utilizar sólo con marcos intermedios de la serie correspondiente
- Tomas TV de Hirschmann

## Marcos intermedios



#### Anillo adaptador para tapa 50 x 50 mm

Descripción	Referencia	Emb.	Precio (€)
<b>Blanco, brillo</b>	1109 90 82	10	<b>2,31</b>
<b>Blanco polar, brillo</b>	1109 90 89	10	<b>2,31</b>
<b>Blanco polar, mate</b>	1109 19 19	10	<b>3,51</b>
<b>Antracita</b>	1109 16 16	10	<b>2,69</b>
<b>Aluminio</b>	1109 14 14	10	<b>3,55</b>

1109 19 19



#### Marco intermedio para tapas centrales

Descripción	Referencia	Emb.	Precio (€)
<b>Blanco, brillo</b>	1109 89 82	10	<b>2,90</b>
<b>Blanco polar, brillo</b>	1109 89 89	10	<b>2,51</b>
<b>Blanco polar, mate</b>	1109 19 09	10	<b>2,18</b>
<b>Antracita</b>	1109 16 06	10	<b>3,51</b>
<b>Aluminio</b>	1109 14 04	10	<b>4,23</b>

1109 19 09



#### Portaetiquetas para marco intermedio

Descripción	Referencia	Emb.	Precio (€)
<b>Blanco, brillo</b>	1905 00 02	10	<b>4,63</b>
<b>Blanco polar, brillo</b>	1905 00 69	10	<b>4,63</b>
<b>Acero</b>	1905 70 04	10	<b>7,64</b>

## Tapa salida de cables



#### Tapa central para salida de cable

Descripción	Referencia	Emb.	Precio (€)
<b>Blanco, brillo</b>	1019 89 82	10	<b>4,84</b>
<b>Blanco polar, brillo</b>	1019 89 89	10	<b>4,84</b>
<b>Blanco polar, mate</b>	1019 19 09	10	<b>5,87</b>
<b>Antracita</b>	1019 16 06	10	<b>9,00</b>
<b>Aluminio</b>	1019 14 04	10	<b>12,59</b>

1019 19 09

## Tapas altavoz / datos / telecomunicaciones



#### Tapa central para toma TAE y altavoz

Descripción	Referencia	Emb.	Precio (€)
<b>Blanco, brillo</b>	1033 89 12	10	<b>5,91</b>
<b>Blanco polar, brillo</b>	1033 89 19	10	<b>5,91</b>
<b>Blanco polar, mate</b>	1033 19 09	10	<b>6,66</b>
<b>Antracita</b>	1033 16 06	10	<b>9,40</b>
<b>Aluminio</b>	1033 14 04	10	<b>12,72</b>

1033 89 19



#### Tapa central para toma TAE 6/6FFy 6/6NF y altavoz

Descripción	Referencia	Emb.	Precio (€)
<b>Blanco, brillo</b>	1458 02	10	<b>4,75</b>
<b>Blanco polar, brillo</b>	1458 09	10	<b>4,75</b>
<b>Marrón</b>	1458 01	10	<b>11,04</b>

1458 09



#### Tapa central para toma teléfono / red

Descripción	Referencia	Emb.	Precio (€)
<b>Blanco, brillo</b>	1407 89 82	10	<b>4,84</b>
<b>Blanco polar, brillo</b>	1407 89 89	10	<b>4,84</b>
<b>Blanco polar, mate</b>	1407 19 09	10	<b>4,84</b>
<b>Antracita</b>	1407 16 06	10	<b>7,31</b>
<b>Aluminio</b>	1407 14 04	10	<b>10,32</b>

1407 19 09



#### Tapa central para toma teléfono / red doble

Descripción	Referencia	Emb.	Precio (€)
<b>Blanco, brillo</b>	1409 89 82	10	<b>5,78</b>
<b>Blanco polar, brillo</b>	1409 89 89	10	<b>5,78</b>
<b>Blanco polar, mate</b>	1409 19 09	10	<b>7,10</b>
<b>Antracita</b>	1409 16 06	10	<b>8,82</b>
<b>Aluminio</b>	1409 14 04	10	<b>12,47</b>

1409 19 09



#### Tapa central protección suciedad y portaetiquetas

Descripción	Referencia	Emb.	Precio (€)
<b>Blanco polar, mate</b>	1170 19 09	10	<b>11,31</b>
<b>Antracita</b>	1170 16 06	10	<b>16,57</b>
<b>Aluminio</b>	1170 14 04	10	<b>22,23</b>

1170 19 09



#### Tapa central protección suciedad y portaetiq. doble

Descripción	Referencia	Emb.	Precio (€)
<b>Blanco, brillo</b>	1181 89 82	10	<b>11,38</b>
<b>Blanco polar, brillo</b>	1181 89 89	10	<b>11,38</b>
<b>Blanco polar, mate</b>	1181 19 09	10	<b>15,40</b>
<b>Antracita</b>	1181 16 06	10	<b>21,06</b>
<b>Aluminio</b>	1181 14 04	10	<b>22,87</b>

1181 19 09



1494 09

### Tapa central para AMP-ACO

Descripción	Referencia	Emb.	Precio (€)
<b>Blanco, brillo</b>	1494 02	10	<b>5,27</b>
<b>Blanco polar, brillo</b>	1494 09	10	<b>5,27</b>
<b>Blanco polar, mate</b>	1494 19 09	10	<b>5,78</b>
<b>Antracita</b>	1494 16 06	10	<b>8,35</b>

- Utilizar sólo con marcos intermedios de la serie correspondiente
- Portaetiquetas no disponible



1495 09

### Tapa central para AMP-ACO con portaetiquetas

Descripción	Referencia	Emb.	Precio (€)
<b>Blanco polar, mate</b>	1495 19 09	10	<b>9,69</b>

- Utilizar sólo con marcos intermedios de la serie correspondiente

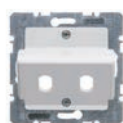

1492 09

### Tapa central acopladores de fibra óptica Simplex ST

Descripción	Referencia	Emb.	Precio (€)
<b>Blanco, brillo</b>	1492 02	10	<b>20,43</b>
<b>Blanco polar, brillo</b>	1492 09	10	<b>20,43</b>
<b>Blanco polar, mate</b>	1492 19 09	10	<b>23,97</b>

- Utilizar sólo con marcos intermedios de la serie correspondiente



1480 09

### Tapa central acopladores fibra óptica Duplex SC

Descripción	Referencia	Emb.	Precio (€)
<b>Blanco, brillo</b>	1480 02	10	<b>21,06</b>
<b>Blanco polar, brillo</b>	1480 09	10	<b>21,06</b>
<b>Blanco polar, mate</b>	1480 19 09	10	<b>23,97</b>

- Utilizar sólo con marcos intermedios de la serie correspondiente



1411 19 09

### Tapa central para conector 1 D-subminiatura

Descripción	Referencia	Emb.	Precio (€)
<b>Blanco polar, brillo</b>	1411 09	10	<b>9,50</b>
<b>Blanco polar, mate</b>	1411 19 09	10	<b>9,64</b>

- Utilizar sólo con marcos intermedios de la serie correspondiente



1470 19 09

### Tapa central para conector 2 D-subminiatura

Descripción	Referencia	Emb.	Precio (€)
<b>Blanco polar, brillo</b>	1470 09	10	<b>18,96</b>
<b>Blanco polar, mate</b>	1470 19 09	10	<b>20,50</b>

- Utilizar sólo con marcos intermedios de la serie correspondiente

## Tapa toma USB de carga



68 1033 89 82

### Tapa toma USB de carga

Descripción	Referencia	Emb.	Precio (€)
<b>Blanco, brillo</b>	68 1033 89 82	10	<b>4,53</b>
<b>Blanco polar, brillo</b>	68 1033 89 89	10	<b>4,53</b>
<b>Blanco polar, mate</b>	68 1033 19 09	10	<b>4,79</b>
<b>Antracita</b>	68 1033 16 06	10	<b>7,06</b>
<b>Aluminio</b>	68 1033 14 04	10	<b>7,06</b>

## Unidades de señalización y gestión

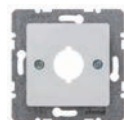

1431 09

### Tapa transmisión y control de dispositivo 18\*8 mm

Descripción	Referencia	Emb.	Precio (€)
<b>Blanco, brillo</b>	1431 02	10	<b>9,88</b>
<b>Blanco polar, brillo</b>	1431 09	10	<b>9,88</b>
<b>Blanco polar, mate</b>	1431 19 09	10	<b>11,74</b>
<b>Antracita</b>	1431 16 06	10	<b>14,89</b>
<b>Aluminio</b>	1431 14 04	10	<b>18,75</b>
<b>Acero</b>	1431 04	10	<b>20,67</b>

- Utilizar sólo con marcos intermedios de la serie correspondiente
- Mecanismo ref: 4604

## Tapas sistemas hospitalarios



1403 19 09

### Tapa toma doble equipotencial

Descripción	Referencia	Emb.	Precio (€)
<b>Blanco, brillo</b>	1403 02	10	<b>9,88</b>
<b>Blanco polar, brillo</b>	1403 09	10	<b>9,88</b>
<b>Blanco polar, mate</b>	1403 19 09	10	<b>9,75</b>
<b>Antracita</b>	1403 16 06	10	<b>12,84</b>
<b>Aluminio</b>	1403 14 04	10	<b>18,50</b>

- Mecanismo ref: 1061



1474 09

### Tapa para toma 6 polos / Timbre

Descripción	Referencia	Emb.	Precio (€)
<b>Blanco, brillo</b>	1474 02	10	<b>8,35</b>
<b>Blanco polar, brillo</b>	1474 09	10	<b>8,35</b>
<b>Blanco polar, mate</b>	1474 19 09	10	<b>9,11</b>
<b>Antracita</b>	1474 16 06	10	<b>10,78</b>
<b>Aluminio</b>	1474 14 04	10	<b>14,52</b>
<b>Acero</b>	1474 04	10	<b>25,92</b>

- Utilizar sólo con marcos intermedios correspondientes para BBH01:

1109 89 82 - Blanco  
 1109 89 89 - Blanco polar brillo  
 1109 19 09 - Blanco polar mate  
 1109 14 04 - Aluminio  
 1109 16 06 - Antracita



# berker Q.1

Gracias a su superficie cuenta con un tacto inconfundible y único, así como con variantes de color muy atractivas en antracita, aluminio, y blanco polar.

Con un perfil y ángulo de conmutación plano y contornos suavemente redondeados resulta poderosamente estético.

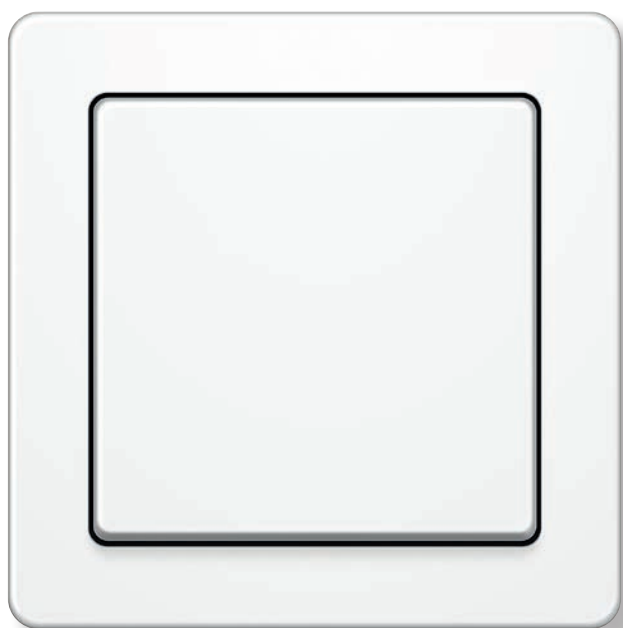

reddot design award  
winner 2009

DESIGN PLUS





# berker Q.3

**Robustez.** Cuesta pensar en una palabra que defina mejor berker Q.3. Sus claros contornos y su resistencia a los arañazos, convierten este interruptor en un fiel compañero. Cuenta con los mismos mecanismos que su programa hermano, berker Q.1. Asimismo, destaca por sus ventajas funcionales: berker Q.3 resulta especialmente indicado para la instalación en canal de distribución.



IT CHOOSES YOU - MIRANDA JULY  
ART AT THE TURN OF THE MILLENNIUM  
PICASSO BEI DER ARBEIT  
snyhans



# berker Q.7

La vivienda es siempre un reflejo de las personas que viven en ella. La forma geométrica de la gama berker Q.7 no engaña. Desde el primer instante, muestra similitudes con las gamas berker Q.1 y berker Q.3. Sin embargo, además de los materiales exclusivos, sus dimensiones también marcan la diferencia.



## Marcos berker Q.1



1011 60 89

## Marcos blanco polar

Descripción	Referencia	Emb.	Precio (€)
<b>1 elemento</b>	1011 60 89	10	<b>2,04</b>
<b>2 elementos</b>	1012 60 89	10	<b>3,82</b>
<b>3 elementos</b>	1013 60 89	2	<b>6,15</b>
<b>4 elementos</b>	1014 60 89	2	<b>8,55</b>
<b>5 elementos</b>	1015 60 89	2	<b>13,82</b>

- Montaje vertical y horizontal



1012 60 86

## Marcos antracita

Descripción	Referencia	Emb.	Precio (€)
<b>1 elemento</b>	1011 60 86	10	<b>5,92</b>
<b>2 elementos</b>	1012 60 86	10	<b>8,57</b>
<b>3 elementos</b>	1013 60 86	2	<b>14,84</b>
<b>4 elementos</b>	1014 60 86	2	<b>23,59</b>
<b>5 elementos</b>	1015 60 86	2	<b>36,48</b>

- Montaje vertical y horizontal



1012 60 84

## Marcos aluminio

Descripción	Referencia	Emb.	Precio (€)
<b>1 elemento</b>	1011 60 84	10	<b>5,92</b>
<b>2 elementos</b>	1012 60 84	10	<b>8,57</b>
<b>3 elementos</b>	1013 60 84	2	<b>14,84</b>
<b>4 elementos</b>	1014 60 84	2	<b>23,59</b>
<b>5 elementos</b>	1015 60 84	2	<b>36,48</b>

- Montaje vertical y horizontal



1011 60 62

## Marcos rojo

Descripción	Referencia	Emb.	Precio (€)
<b>1 elemento</b>	1011 60 62	10	<b>2,17</b>
<b>2 elementos</b>	1012 60 62	10	<b>4,21</b>
<b>3 elementos</b>	1013 60 62	2	<b>6,39</b>
<b>4 elementos</b>	1014 60 62	2	<b>8,96</b>
<b>5 elementos</b>	1015 60 62	2	<b>14,56</b>

- Montaje vertical y horizontal
- Para resaltar interruptores especiales, tomas de corriente, ...
- Marco c/ portaetiquetas blanco



1011 60 19

## Marcos c/portaetiquetas blanco polar

Descripción	Referencia	Emb.	Precio (€)
<b>1 elemento</b>	1011 60 19	10	<b>6,04</b>
<b>2 elementos vertical</b>	1012 60 19	10	<b>34,62</b>
<b>3 elementos vertical</b>	1013 60 19	10	<b>48,10</b>
<b>4 elementos vertical</b>	1014 60 19	2	<b>63,26</b>
<b>5 elementos vertical</b>	1015 60 19	2	<b>80,81</b>
<b>2 elementos horizontal</b>	1022 60 19	10	<b>34,62</b>
<b>3 elementos horizontal</b>	1023 60 19	10	<b>48,10</b>
<b>4 elementos horizontal</b>	1024 60 19	2	<b>63,26</b>
<b>5 elementos horizontal</b>	1025 60 19	2	<b>80,81</b>

- Etiquetas de 6 mm alto



1011 60 16

## Marcos c/portaetiquetas antracita

Descripción	Referencia	Emb.	Precio (€)
<b>1 elemento</b>	1011 60 16	10	<b>13,37</b>
<b>2 elementos vertical</b>	1012 60 16	10	<b>39,34</b>
<b>3 elementos vertical</b>	1013 60 16	10	<b>54,90</b>
<b>4 elementos vertical</b>	1014 60 16	2	<b>72,06</b>
<b>5 elementos vertical</b>	1015 60 16	2	<b>92,40</b>
<b>2 elementos horizontal</b>	1022 60 16	10	<b>39,34</b>
<b>3 elementos horizontal</b>	1023 60 16	10	<b>54,90</b>
<b>4 elementos horizontal</b>	1024 60 16	2	<b>72,06</b>
<b>5 elementos horizontal</b>	1025 60 16	2	<b>92,40</b>

- Etiquetas de 6 mm alto
- Marco c/ portaetiquetas blanco



1011 60 14

## Marcos c/portaetiquetas aluminio

Descripción	Referencia	Emb.	Precio (€)
<b>1 elemento</b>	1011 60 14	10	<b>13,37</b>
<b>2 elementos vertical</b>	1012 60 14	10	<b>39,34</b>
<b>3 elementos vertical</b>	1013 60 14	10	<b>54,90</b>
<b>4 elementos vertical</b>	1014 60 14	2	<b>72,06</b>
<b>5 elementos vertical</b>	1015 60 14	2	<b>92,40</b>
<b>2 elementos horizontal</b>	1022 60 14	10	<b>39,34</b>
<b>3 elementos horizontal</b>	1023 60 14	10	<b>54,90</b>
<b>4 elementos horizontal</b>	1024 60 14	2	<b>72,06</b>
<b>5 elementos horizontal</b>	1025 60 14	2	<b>92,40</b>

- Etiquetas de 6 mm alto
- Marco c/ portaetiquetas blanco

## Marcos para teclados KNX berker Q.1



1309 60 89

Descripción	Referencia	Emb.	Precio (€)
<b>Blanco polar</b>	1309 60 89	10	<b>8,31</b>
<b>Antracita</b>	1309 60 86	10	<b>8,57</b>
<b>Aluminio</b>	1309 60 84	10	<b>8,57</b>

- Montaje vertical
- \* Familia 97

## Cajas montaje superficie berker Q.1



1029 00 69

## Caja montaje en superficie 1 elemento

Descripción	Referencia	Emb.	Precio (€)
<b>Blanco polar, brillo</b>	1029 00 69	10	<b>12,51</b>
<b>Antracita</b>	1029 60 86	10	<b>12,88</b>
<b>Rojo, brillo</b>	1029 00 62	10	<b>14,20</b>

- Profundidad instalación 33,5 mm



1030 00 69

## Caja montaje en superficie 2 elementos

Descripción	Referencia	Emb.	Precio (€)
<b>Blanco polar, brillo</b>	1030 00 69	10	<b>13,42</b>
<b>Antracita</b>	1030 60 86	10	<b>22,11</b>
<b>Rojo brillo</b>	1030 00 62	10	<b>19,67</b>

- Profundidad instalación 33,5 mm



1031 00 69

## Caja montaje en superficie 3 elementos

Descripción	Referencia	Emb.	Precio (€)
<b>Blanco polar, brillo</b>	1031 00 69	5	<b>16,55</b>
<b>Antracita</b>	1031 60 86	5	<b>34,61</b>
<b>Rojo, brillo</b>	1031 00 62	5	<b>28,67</b>

- Profundidad instalación 33,5 mm

**Nota:** En instalaciones en paredes de tabique hueco, se recomienda dejar la caja de empotrar enrasada con la pared con el fin de que la instalación de nuestras series de mecanismos se realice de la manera que se han diseñado. Recomendamos el uso de una sierra de corona con avellanador.

## Marcos berker Q.3



### Marcos blanco polar

1011 60 99

Descripción	Referencia	Emb.	Precio (€)
<b>1 elemento</b>	1011 60 99	10	<b>3,08</b>
<b>2 elementos</b>	1012 60 99	10	<b>3,82</b>
<b>3 elementos</b>	1013 60 99	2	<b>6,15</b>
<b>4 elementos</b>	1014 60 99	2	<b>8,55</b>
<b>5 elementos</b>	1015 60 99	2	<b>13,82</b>

• Montaje vertical y horizontal



### Marcos antracita

1012 60 96

Descripción	Referencia	Emb.	Precio (€)
<b>1 elemento</b>	1011 60 96	10	<b>5,92</b>
<b>2 elementos</b>	1012 60 96	10	<b>8,57</b>
<b>3 elementos</b>	1013 60 96	2	<b>14,84</b>
<b>4 elementos</b>	1014 60 96	2	<b>23,59</b>
<b>5 elementos</b>	1015 60 96	2	<b>36,48</b>

• Montaje vertical y horizontal



### Marcos aluminio

1011 60 94

Descripción	Referencia	Emb.	Precio (€)
<b>1 elemento</b>	1011 60 94	10	<b>5,92</b>
<b>2 elementos</b>	1012 60 94	2	<b>8,57</b>
<b>3 elementos</b>	1013 60 94	2	<b>14,84</b>
<b>4 elementos</b>	1014 60 94	2	<b>23,59</b>
<b>5 elementos</b>	1015 60 94	2	<b>36,48</b>

• Montaje vertical y horizontal



### Marcos c/portaetiquetas blanco polar

1051 60 99

Descripción	Referencia	Emb.	Precio (€)
<b>1 elemento</b>	1051 60 99	10	<b>6,04</b>
<b>2 elementos vertical</b>	1052 60 99	10	<b>34,62</b>
<b>3 elementos vertical</b>	1053 60 99	10	<b>48,10</b>
<b>2 elementos horizontal</b>	1022 60 99	10	<b>34,62</b>
<b>3 elementos horizontal</b>	1023 60 99	10	<b>48,10</b>

• Etiquetas de 6 mm alto



### Marcos c/portaetiquetas aluminio

1051 60 94

Descripción	Referencia	Emb.	Precio (€)
<b>1 elemento</b>	1051 60 94	10	<b>6,04</b>
<b>2 elementos vertical</b>	1052 60 94	10	<b>34,62</b>
<b>3 elementos vertical</b>	1053 60 94	10	<b>48,10</b>
<b>2 elementos horizontal</b>	1022 60 94	10	<b>34,62</b>
<b>3 elementos horizontal</b>	1023 60 94	10	<b>48,10</b>

## Marcos para teclados KNX berker Q.3



1309 60 99

Descripción	Referencia	Emb.	Precio (€)
<b>Blanco polar</b>	1309 60 99	2	<b>8,31</b>
<b>Antracita</b>	1309 60 96	2	<b>8,57</b>
<b>Aluminio</b>	1309 60 94	2	<b>8,57</b>

• Montaje vertical

## Cajas montaje superficie berker Q.3

Para berker Q.3 utilizar las referencias de la pág. 88 (mismas que para berker S.1)

**Nota:** En instalaciones en paredes de tabique hueco, se recomienda dejar la caja de empotrar enrasada con la pared con el fin de que la instalación de nuestras series de mecanismos se realice de la manera que se han diseñado. Recomendamos el uso de una sierra de corona con avellanador.

## Marcos berker Q.7



1011 61 89

## Marcos blanco polar

Descripción	Referencia	Emb.	Precio (€)
<b>1 elemento</b>	1011 61 89	10	<b>6,32</b>
<b>2 elementos</b>	1012 61 89	5	<b>9,20</b>
<b>3 elementos</b>	1013 61 89	5	<b>15,88</b>
<b>4 elementos</b>	1014 61 89	1	<b>25,52</b>
<b>5 elementos</b>	1015 61 89	1	<b>38,87</b>

- Montaje vertical y horizontal



1011 61 86

## Marcos antracita

Descripción	Referencia	Emb.	Precio (€)
<b>1 elemento</b>	1011 61 86	10	<b>8,42</b>
<b>2 elementos</b>	1012 61 86	5	<b>13,18</b>
<b>3 elementos</b>	1013 61 86	5	<b>21,20</b>
<b>4 elementos</b>	1014 61 86	1	<b>34,16</b>
<b>5 elementos</b>	1015 61 86	1	<b>51,97</b>

- Montaje vertical y horizontal



1011 61 84

## Marcos aluminio

Descripción	Referencia	Emb.	Precio (€)
<b>1 elemento</b>	1011 61 84	10	<b>8,42</b>
<b>2 elementos</b>	1012 61 84	10	<b>13,18</b>
<b>3 elementos</b>	1013 61 84	2	<b>21,20</b>
<b>4 elementos</b>	1014 61 84	2	<b>34,16</b>
<b>5 elementos</b>	1015 61 84	2	<b>51,97</b>

- Montaje vertical y horizontal



1011 60 79

## Marcos cristal, blanco polar

Descripción	Referencia	Emb.	Precio (€)
<b>1 elemento</b>	1011 60 79	10	<b>41,97</b>
<b>2 elementos</b>	1012 60 79	10	<b>74,07</b>
<b>3 elementos</b>	1013 60 79	2	<b>123,87</b>
<b>4 elementos</b>	1014 60 79	2	<b>169,42</b>
<b>5 elementos</b>	1015 60 79	2	<b>230,91</b>

- Montaje vertical y horizontal



1011 60 76

## Marcos cristal, negro

Descripción	Referencia	Emb.	Precio (€)
<b>1 elemento</b>	1011 60 76	10	<b>41,97</b>
<b>2 elementos</b>	1012 60 76	10	<b>74,07</b>
<b>3 elementos</b>	1013 60 76	2	<b>123,87</b>
<b>4 elementos</b>	1014 60 76	2	<b>169,42</b>
<b>5 elementos</b>	1015 60 76	2	<b>230,91</b>

- Montaje vertical y horizontal



1011 60 74

## Marcos aluminio mate

Descripción	Referencia	Emb.	Precio (€)
<b>1 elemento</b>	1011 60 74	10	<b>54,73</b>
<b>2 elementos</b>	1012 60 74	10	<b>96,64</b>
<b>3 elementos</b>	1013 60 74	2	<b>161,58</b>
<b>4 elementos</b>	1014 60 74	2	<b>221,01</b>
<b>5 elementos</b>	1015 60 74	2	<b>301,19</b>

- Montaje vertical y horizontal



1011 60 83

## Marcos acero inoxidable cepillado

Descripción	Referencia	Emb.	Precio (€)
<b>1 elemento</b>	1011 60 83	10	<b>54,73</b>
<b>2 elementos vertical</b>	1012 60 83	10	<b>96,64</b>
<b>3 elementos vertical</b>	1013 60 83	10	<b>161,58</b>
<b>4 elementos vertical</b>	1014 60 83	2	<b>221,01</b>
<b>5 elementos vertical</b>	1015 60 83	2	<b>301,19</b>
<b>2 elementos horizontal</b>	1022 60 83	10	<b>96,64</b>
<b>3 elementos horizontal</b>	1023 60 83	10	<b>161,58</b>
<b>4 elementos horizontal</b>	1024 60 83	2	<b>221,01</b>
<b>5 elementos horizontal</b>	1025 60 83	2	<b>301,19</b>

## Marcos pizarra natural



1011 60 30

Descripción	Referencia	Emb.	Precio (€)
<b>1 elemento</b>	1011 60 30	1	<b>54,73</b>
<b>2 elementos</b>	1012 60 30	1	<b>96,64</b>
<b>3 elementos</b>	1013 60 30	1	<b>161,58</b>

- Montaje vertical y horizontal



1011 60 20

## Marcos hormigón

Descripción	Referencia	Emb.	Precio (€)
<b>1 elemento</b>	1011 60 20	1	<b>54,73</b>
<b>2 elementos</b>	1012 60 20	1	<b>96,64</b>
<b>3 elementos</b>	1013 60 20	1	<b>161,58</b>

- Montaje vertical y horizontal

## Marcos para teclados KNX berker Q.7



1309 61 89

Descripción	Referencia	Emb.	Precio (€)
<b>Blanco polar</b>	1309 61 89	1	<b>14,49</b>
<b>Antracita</b>	1309 61 86	1	<b>14,49</b>
<b>Aluminio</b>	1309 61 84	1	<b>14,49</b>
<b>Cristal blanco polar</b>	1309 60 79	1	<b>103,37</b>
<b>Cristal negro</b>	1309 60 76	1	<b>103,37</b>
<b>Aluminio pulido</b>	1309 60 74	1	<b>124,06</b>
<b>Acero inoxidable cepillado</b>	1309 60 83	1	<b>124,06</b>
<b>Pizarra</b>	1309 60 30	1	<b>124,06</b>
<b>Hormigón</b>	1309 60 20	1	<b>124,06</b>

- Montaje vertical
- No recomendado para montaje en cajas de superficie

**Nota:** En instalaciones en paredes de tabique hueco, se recomienda dejar la caja de empotrar enrasada con la pared con el fin de que la instalación de nuestras series de mecanismos se realice de la manera que se han diseñado. Recomendamos el uso de una sierra de corona con avellanador.

**Nota:** La madera, piel, pizarra y hormigón son un material natural. Las desviaciones en color y estructura son parte de sus propiedades y no representan ningún defecto sino, que hablan de la calidad individual del material y de los productos.

## Marcos berker Q.7 iluminable



1011 61 09

### 1 elemento

Descripción	Referencia	Emb.	Precio (€)
<b>Blanco polar</b>	1011 61 09	1	<b>15,79</b>
<b>Antracita</b>	1011 61 06	1	<b>24,42</b>
<b>Aluminio</b>	1011 61 04	1	<b>24,42</b>
<b>Aluminio cepillado</b>	1011 61 74	1	<b>68,22</b>
<b>Acero</b>	1011 61 83	1	<b>68,22</b>
<b>Cristal blanco polar</b>	1011 61 79	1	<b>48,73</b>
<b>Cristal negro</b>	1011 61 76	1	<b>48,73</b>
<b>Pizarra</b>	1011 61 30	1	<b>68,22</b>
<b>Hormigón</b>	1011 61 20	1	<b>68,22</b>

•Añadir el módulo de iluminación

## Módulos de iluminación



1680 50

### Módulo LED

Descripción	Referencia	Emb.	Precio (€)
<b>Corona</b>	1680 50	1	<b>123,04</b>
<b>Downlight*</b>	1680 55	1	<b>123,04</b>

\*Encendido automático según sensor de luminosidad



1680 55

### Corona o downlight

berker Q.7 iluminado está disponible en dos variantes: Como una corona con iluminación integral, o como un downlight con luz cono en la parte inferior y sensor crepuscular, que significa que la luz del marco solo se enciende por debajo de un valor crepuscular fijo.

La luminosidad puede ajustarse entre 100% y 50% en ambas variantes.

Un interruptor debajo del soporte marco se utiliza para esto, que se puede ajustar fácilmente por el usuario después de quitar el marco. Los LED tienen una vida útil de 30.000 horas.

Después de este tiempo, siguen funcionando con un 50% de su luminosidad original.



#### La corona se usa como:

- Luz de orientación cerca de las salidas
- Luz de acento para áreas de operación particularmente importantes
- Luz nocturna antideslumbrante para pasillos y habitaciones infantiles
- Interruptor de baño con indicador "ocupado"



#### El downlight se utiliza como:

- Luz de indicación
- Luz nocturna discreta para el baño
- Iluminación discreta en áreas de entrada

**Nota:** En instalaciones en paredes de tabique hueco, se recomienda dejar la caja de empotrar enrasada con la pared con el fin de que la instalación de nuestras series de mecanismos se realice de la manera que se han diseñado. Recomendamos el uso de una sierra de corona con avellanador.

## Tomas de corriente



1719 60 89

## Tapa para SCHUKO

Descripción	Referencia	Emb.	Precio (€)
<b>Blanco polar</b>	1719 60 89	10	<b>4,96</b>
<b>Antracita</b>	1719 60 86	10	<b>6,97</b>
<b>Aluminio</b>	1719 60 84	10	<b>6,97</b>
<b>Rojo</b>	1719 60 12	10	<b>5,06</b>

- Añadir mecanismo ref. 714134
- Con protección infantil



4110 60 89

## Toma SCHUKO con LED de control

Descripción	Referencia	Emb.	Precio (€)
<b>Blanco polar</b>	4110 60 89	10	<b>82,41</b>
<b>Antracita</b>	4110 60 86	10	<b>82,41</b>
<b>Aluminio</b>	4110 60 84	10	<b>82,41</b>

- 16A, 250 V~
- Con protección infantil
- Etiquetas de 6 mm alto
- Conexión tornillo



1720 60 89

## Tapa para SCHUKO con tapa articulada

Descripción	Referencia	Emb.	Precio (€)
<b>Blanco polar</b>	1720 60 89	10	<b>14,11</b>
<b>Antracita</b>	1720 60 86	10	<b>13,85</b>
<b>Aluminio</b>	1720 60 84	10	<b>13,85</b>

- Añadir mecanismo ref. 714134



73 4123 60 89

## Toma SCHUKO completa

Descripción	Referencia	Emb.	Precio (€)
<b>Blanco polar</b>	73 4123 60 89	10	<b>10,06</b>

- Incluye mecanismo ref. 714134 y tapa ref. 1719 60 89



4803 60 89

## Toma SCHUKO con USB 2x A

Descripción	Referencia	Emb.	Precio (€)
<b>Blanco polar</b>	4803 60 89	1	<b>76,78</b>
<b>Antracita</b>	4803 60 86	1	<b>78,96</b>
<b>Aluminio</b>	4803 60 84	1	<b>78,96</b>

- 16A, 250 V~
- USB: 2x USB tipo A  
5 V 2,4 A
- Espacio reducido para cableado
- Apta para cable flexible



4804 60 89

## Toma SCHUKO con USB A+C

Descripción	Referencia	Emb.	Precio (€)
<b>Blanco polar</b>	4804 60 89	1	<b>86,58</b>
<b>Antracita</b>	4804 60 86	1	<b>89,17</b>
<b>Aluminio</b>	4804 60 84	1	<b>93,26</b>

- 16A, 250 V~
- USB: USB tipo A + USB tipo C
- Espacio reducido para cableado
- Apta para cable flexible



4149 60 89

## Toma SCHUKO con portaetiquetas

Descripción	Referencia	Emb.	Precio (€)
<b>Blanco polar</b>	4149 60 89	10	<b>13,29</b>
<b>Antracita</b>	4149 60 86	10	<b>13,29</b>
<b>Aluminio</b>	4149 60 84	10	<b>13,29</b>

- 16A, 250 V~
- Con protección infantil
- Etiquetas de 6 mm alto
- Conexión tornillo



4109 60 89

## Toma SCHUKO con LED de orientación

Descripción	Referencia	Emb.	Precio (€)
<b>Blanco polar</b>	4109 60 89	10	<b>95,74</b>
<b>Antracita</b>	4109 60 86	10	<b>95,74</b>
<b>Aluminio</b>	4109 60 84	10	<b>95,74</b>

- 16A, 250 V~
- Con protección infantil
- Conexión tornillo

## Kits de sellado IP44 berker Q.x / K.x



1010 72 00

## Para tomas SCHUKO y tapas

Descripción	Referencia	Emb.	Precio (€)
<b>Transparente</b>	1010 72 00	1	<b>8,63</b>



1010 71 00

## Para tecla interruptor y pulsador

Descripción	Referencia	Emb.	Precio (€)
<b>Transparente</b>	1010 71 00	1	<b>14,19</b>



1010 70 00

## Para interruptor/pulsador de llave

Descripción	Referencia	Emb.	Precio (€)
<b>Transparente</b>	1010 70 00	1	<b>20,55</b>

## Teclas



1620 60 89

### Tecla

Descripción	Referencia	Emb.	Precio (€)
<b>Blanco polar</b>	1620 60 89	10	<b>2,81</b>
<b>Antracita</b>	1620 60 86	10	<b>4,91</b>
<b>Aluminio</b>	1620 60 84	10	<b>4,91</b>



1620 60 49

### Tecla con símbolo luz

Descripción	Referencia	Emb.	Precio (€)
<b>Blanco polar</b>	1620 60 49	10	<b>3,64</b>
<b>Antracita</b>	1620 60 46	10	<b>6,52</b>
<b>Aluminio</b>	1620 60 44	10	<b>6,52</b>



1620 60 59

### Tecla con símbolo campana

Descripción	Referencia	Emb.	Precio (€)
<b>Blanco polar</b>	1620 60 59	10	<b>3,64</b>
<b>Antracita</b>	1620 60 56	10	<b>6,52</b>
<b>Aluminio</b>	1620 60 54	10	<b>6,52</b>



1620 60 69

### Tecla con símbolo llave

Descripción	Referencia	Emb.	Precio (€)
<b>Blanco polar</b>	1620 60 69	10	<b>3,64</b>
<b>Antracita</b>	1620 60 66	10	<b>6,52</b>
<b>Aluminio</b>	1620 60 64	10	<b>6,52</b>



1626 60 89

### Tecla con portaetiquetas

Descripción	Referencia	Emb.	Precio (€)
<b>Blanco polar</b>	1626 60 89	10	<b>10,98</b>
<b>Antracita</b>	1626 60 86	10	<b>11,94</b>
<b>Aluminio</b>	1626 60 84	10	<b>11,94</b>

- Etiquetas de 6 mm alto



1621 60 89

### Tecla con 2 indicadores luminosos

Descripción	Referencia	Emb.	Precio (€)
<b>Blanco polar</b>	1621 60 89	10	<b>10,27</b>
<b>Antracita</b>	1621 60 86	10	<b>14,55</b>
<b>Aluminio</b>	1621 60 84	10	<b>14,55</b>

- Indicador luminoso naranja y blanco



1621 60 79

### Tecla con 2 indicadores luminosos y símbolo luz

Descripción	Referencia	Emb.	Precio (€)
<b>Blanco polar</b>	1621 60 79	10	<b>11,69</b>
<b>Antracita</b>	1621 60 76	10	<b>14,93</b>
<b>Aluminio</b>	1621 60 74	10	<b>14,93</b>

- Indicador luminoso naranja y blanco



1628 60 89

### Tecla con 2 indicadores luminosos y portaetiquetas

Descripción	Referencia	Emb.	Precio (€)
<b>Blanco polar</b>	1628 60 89	10	<b>12,37</b>
<b>Antracita</b>	1628 60 86	10	<b>18,98</b>
<b>Aluminio</b>	1628 60 84	10	<b>18,98</b>

- Etiquetas de 6 mm alto



1628 60 79

### Tecla con 2 indicadores luminosos, portaetiquetas y símbolo campana

Descripción	Referencia	Emb.	Precio (€)
<b>Blanco polar</b>	1628 60 79	10	<b>12,37</b>
<b>Antracita</b>	1628 60 76	10	<b>18,36</b>
<b>Aluminio</b>	1628 60 74	10	<b>18,36</b>

- Etiquetas de 6 mm alto en la parte inferior



1696 60 89

### Tecla con 2 indicadores luminosos y portaetiquetas grande

Descripción	Referencia	Emb.	Precio (€)
<b>Blanco polar</b>	1696 60 89	10	<b>12,14</b>
<b>Antracita</b>	1696 60 86	10	<b>20,11</b>
<b>Aluminio</b>	1696 60 84	10	<b>20,11</b>

- Etiquetas de 2 x 18 mm alto



1696 60 79

### Tecla con 2 indicadores luminosos, portaetiquetas grande y símbolo campana

Descripción	Referencia	Emb.	Precio (€)
<b>Blanco polar</b>	1696 60 79	10	<b>17,44</b>
<b>Antracita</b>	1696 60 76	10	<b>17,58</b>
<b>Aluminio</b>	1696 60 74	10	<b>17,58</b>

- Etiquetas de 2 x 18 mm alto

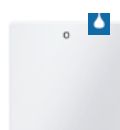

1622 60 89

### Tecla con símbolo "0"

Descripción	Referencia	Emb.	Precio (€)
<b>Blanco polar</b>	1622 60 89	10	<b>13,21</b>
<b>Antracita</b>	1622 60 86	10	<b>16,22</b>
<b>Aluminio</b>	1622 60 84	10	<b>16,22</b>



1624 60 89

### Tecla con símbolo "0" e indicador luminoso naranja

Descripción	Referencia	Emb.	Precio (€)
<b>Blanco polar</b>	1624 60 89	10	<b>11,64</b>
<b>Antracita</b>	1624 60 86	10	<b>15,24</b>
<b>Aluminio</b>	1624 60 84	10	<b>15,24</b>



1150 60 89

### Tapa con mando para interruptores rotativos

Descripción	Referencia	Emb.	Precio (€)
<b>Blanco polar</b>	1150 60 89	1	<b>19,41</b>



1623 60 89

### Tecla doble

Descripción	Referencia	Emb.	Precio (€)
<b>Blanco polar</b>	1623 60 89	10	<b>7,41</b>
<b>Antracita</b>	1623 60 86	10	<b>8,51</b>
<b>Aluminio</b>	1623 60 84	10	<b>8,51</b>



1627 60 89

### Tecla doble con indicador luminoso

Descripción	Referencia	Emb.	Precio (€)
<b>Blanco polar</b>	1627 60 89	10	<b>15,46</b>
<b>Antracita</b>	1627 60 86	10	<b>23,37</b>
<b>Aluminio</b>	1627 60 84	10	<b>23,37</b>

- Indicador luminoso naranja y blanco



1665 60 89

### Tecla para mecanismo triple ON/OFF

Descripción	Referencia	Emb.	Precio (€)
<b>Blanco polar</b>	1665 60 89	10	<b>11,62</b>

- Teclado triple ref. 6330 23



1625 60 89

### Tecla doble persiana

Descripción	Referencia	Emb.	Precio (€)
<b>Blanco polar</b>	1625 60 89	10	<b>8,31</b>
<b>Antracita</b>	1625 60 86	10	<b>11,46</b>
<b>Aluminio</b>	1625 60 84	10	<b>11,46</b>

## Teclas sin barreras



## Tecla simple con 2 indicadores luminosos

Descripción	Referencia	Emb.	Precio (€)
<b>Blanco polar</b>	1661 60 49	10	<b>24,31</b>

1661 60 49



## Tecla simple con lente rojo y símbolo luz en relieve

Descripción	Referencia	Emb.	Precio (€)
<b>Blanco polar</b>	1651 60 49	10	<b>21,80</b>

1651 60 49



## Tecla simple con lente rojo y símbolo campana en relieve

Descripción	Referencia	Emb.	Precio (€)
<b>Blanco polar</b>	1651 60 59	10	<b>21,68</b>

1651 60 59

## Tapas



## Tapa tarjetero de hotel con indicador luminoso

Descripción	Referencia	Emb.	Precio (€)
<b>Blanco polar</b>	1640 60 89	10	<b>50,09</b>
<b>Antracita</b>	1640 60 86	10	<b>51,02</b>
<b>Aluminio</b>	1640 60 84	10	<b>51,02</b>

1640 60 89

- Mecanismo ref.: 5051 02, 5051 03, 5052 01, 5056 01



## Tapa interruptor/pulsador tirador

Descripción	Referencia	Emb.	Precio (€)
<b>Blanco polar</b>	1146 60 89	10	<b>8,79</b>
<b>Antracita</b>	1146 60 86	10	<b>10,65</b>
<b>Aluminio</b>	1146 60 84	10	<b>10,65</b>

1146 60 89

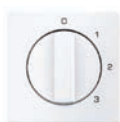

## Tapa para interruptor 3 posiciones con mando rotativo

Descripción	Referencia	Emb.	Precio (€)
<b>Sin posición 0</b>			
<b>Blanco polar</b>	1084 60 89 00	1	<b>20,76</b>
<b>Antracita</b>	1084 60 86 00	1	<b>24,34</b>
<b>Aluminio</b>	1084 60 84 00	1	<b>24,34</b>

1084 60 82 00



## Con posición neutra

<b>Blanco polar</b>	1096 60 89 00	1	<b>21,50</b>
<b>Antracita</b>	1096 60 86 00	1	<b>24,34</b>
<b>Aluminio</b>	1096 60 84 00	1	<b>24,34</b>

1096 60 82 00



## Tapa para interruptor/pulsador rotativo para persianas

Descripción	Referencia	Emb.	Precio (€)
<b>Blanco polar</b>	1080 60 89 00	1	<b>20,77</b>
<b>Antracita</b>	1080 60 86 00	1	<b>24,72</b>
<b>Aluminio</b>	1080 60 84 00	1	<b>24,72</b>

1080 60 89 00



## Tapa con cerradura para interruptor de llave de persianas

Descripción	Referencia	Emb.	Precio (€)
-------------	------------	------	------------

## Llave extraíble en posición media

<b>Blanco polar</b>	1081 60 89 00	1	<b>78,31</b>
<b>Antracita</b>	1081 60 86 00	1	<b>71,96</b>
<b>Aluminio</b>	1081 60 84 00	1	<b>71,96</b>

1081 60 89 00

- Función bloqueo función



## Tapa con cerradura para interruptor de llave de persianas

Descripción	Referencia	Emb.	Precio (€)
-------------	------------	------	------------

## Llave extraíble en 3 posiciones

1082 60 82 00

<b>Blanco polar</b>	1082 60 89 00	1	<b>78,31</b>
<b>Antracita</b>	1082 60 86 00	1	<b>71,96</b>
<b>Aluminio</b>	1082 60 84 00	1	<b>71,96</b>

- Función bloqueo función



## Tapa con cerradura para interruptor de llave de persianas

Descripción	Referencia	Emb.	Precio (€)
-------------	------------	------	------------

## Llave extraíble en posición media

1083 60 89 00

<b>Blanco polar</b>	1083 60 89 00	1	<b>78,31</b>
<b>Antracita</b>	1083 60 86 00	1	<b>71,96</b>
<b>Aluminio</b>	1083 60 84 00	1	<b>71,96</b>

- Función bloqueo función



## Tapa para interruptor / pulsador de llave de persianas

Descripción	Referencia	Emb.	Precio (€)
-------------	------------	------	------------

<b>Blanco polar</b>	1506 60 89	10	<b>18,53</b>
<b>Antracita</b>	1506 60 86	10	<b>19,13</b>
<b>Aluminio</b>	1506 60 84	10	<b>19,13</b>

- Con impresión

<b>Blanco polar</b>	1507 60 89	10	<b>18,53</b>
<b>Antracita</b>	1507 60 86	10	<b>20,15</b>
<b>Aluminio</b>	1507 60 84	10	<b>20,15</b>

- Sin impresión

## Tapas ciegas



## Tapa ciega

Descripción	Referencia	Emb.	Precio (€)
-------------	------------	------	------------

## Sin garras

<b>Blanco polar</b>	1009 60 89	20	<b>12,40</b>
<b>Antracita</b>	1009 60 86	20	<b>24,23</b>
<b>Aluminio</b>	1009 60 84	20	<b>24,23</b>

67 1009 60 89



## Con base y garras

<b>Blanco polar</b>	67 1009 60 89	10	<b>12,40</b>
<b>Antracita</b>	67 1009 60 86	10	<b>14,72</b>
<b>Aluminio</b>	67 1009 60 84	10	<b>14,72</b>

67 1009 60 89



## Tapa ciega atornillada

Descripción	Referencia	Emb.	Precio (€)
-------------	------------	------	------------

<b>Blanco polar</b>	1009 60 79	20	<b>15,23</b>
<b>Antracita</b>	1009 60 76	20	<b>17,81</b>
<b>Aluminio</b>	1009 60 74	20	<b>17,81</b>

1009 60 79

- Sin garras

## Señalización



## Tapa central para piloto / pulsador y lámpara E10

Descripción	Referencia	Emb.	Precio (€)
-------------	------------	------	------------

<b>Blanco polar</b>	1124 60 89	10	<b>4,61</b>
<b>Antracita</b>	1124 60 86	10	<b>8,15</b>
<b>Aluminio</b>	1124 60 84	10	<b>8,15</b>

1124 60 89



## Tapa central para piloto, lámpara E14

Descripción	Referencia	Emb.	Precio (€)
-------------	------------	------	------------

<b>Blanco polar</b>	1198 60 89	10	<b>15,37</b>
<b>Antracita</b>	1198 60 86	10	<b>16,22</b>
<b>Aluminio</b>	1198 60 84	10	<b>16,22</b>

1198 60 89

## Tapa control velocidad

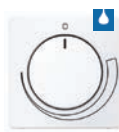

1137 60 79

### Tapa central con mando para control velocidad

Descripción	Referencia	Emb.	Precio (€)
<b>Blanco polar</b>	1137 60 79	10	<b>29,13</b>
<b>Antracita</b>	1137 60 76	10	<b>29,13</b>
<b>Aluminio</b>	1137 60 74	10	<b>29,13</b>

## Temporizadores



1632 60 89

### Tapa con mando rotativo para temporizador mecánico

Descripción	Referencia	Emb.	Precio (€)
<b>Máximo 15 minutos</b>			
<b>Blanco polar</b>	1632 60 89	1	<b>19,69</b>
<b>Antracita</b>	1632 60 86	1	<b>26,18</b>

### Máximo 120 minutos

<b>Blanco polar</b>	1633 60 89	1	<b>19,69</b>
<b>Antracita</b>	1633 60 86	1	<b>26,18</b>

## Llamada emergencia berker Q.1/Q.3 (Marcos incluidos)



5200 60 89

### Kit de llamada de emergencia

Descripción	Referencia	Emb.	Precio (€)
<b>berker Q.1, blanco polar</b>	5200 60 89	1	<b>294,84</b>
<b>berker Q.3, blanco polar</b>	5200 60 99	1	<b>294,84</b>



1674 60 89

### Tapa con pulsador para relé temporizador

Descripción	Referencia	Emb.	Precio (€)
<b>Blanco polar</b>	1674 60 89	10	<b>24,48</b>



5201 60 89

### Pulsador de confirmación

Descripción	Referencia	Emb.	Precio (€)
<b>berker Q.1, blanco polar</b>	5201 60 89	1	<b>38,22</b>
<b>berker Q.3, blanco polar</b>	5201 60 99	1	<b>38,22</b>



1137 60 89

### Tapa central con mando rotativo para regulador rotativo

Descripción	Referencia	Emb.	Precio (€)
<b>Blanco polar</b>	1137 60 89	10	<b>26,95</b>
<b>Antracita</b>	1137 60 86	10	<b>26,95</b>
<b>Aluminio</b>	1137 60 84	10	<b>26,95</b>



5202 60 89

### Pulsador de tirador

Descripción	Referencia	Emb.	Precio (€)
<b>berker Q.1, blanco polar</b>	5202 60 89	1	<b>38,22</b>
<b>berker Q.3, blanco polar</b>	5202 60 99	1	<b>38,22</b>

## Termostatos



2030 60 89

### Termostato con contacto NC, interruptor y LED

Descripción	Referencia	Emb.	Precio (€)
<b>Blanco polar</b>	2030 60 89	1	<b>113,99</b>
<b>Antracita</b>	2030 60 86	1	<b>125,41</b>
<b>Aluminio</b>	2030 60 84	1	<b>125,41</b>



2026 60 89

### Termostato con conmutador

Descripción	Referencia	Emb.	Precio (€)
<b>Blanco polar</b>	2026 60 89	1	<b>113,99</b>
<b>Antracita</b>	2026 60 86	1	<b>127,28</b>
<b>Aluminio</b>	2026 60 84	1	<b>127,28</b>



5203 60 89

### Indicador luminoso

Descripción	Referencia	Emb.	Precio (€)
<b>berker Q.1, blanco polar</b>	5203 60 89	1	<b>155,06</b>
<b>berker Q.3, blanco polar</b>	5203 60 99	1	<b>155,06</b>



2034 60 89

### Termostato de suelo radiante

Descripción	Referencia	Emb.	Precio (€)
<b>Blanco polar</b>	2034 60 89	1	<b>360,96</b>
<b>Antracita</b>	2034 60 86	1	<b>254,89</b>
<b>Aluminio</b>	2034 60 84	1	<b>254,89</b>



5204 60 89

### Fuente de alimentación

Descripción	Referencia	Emb.	Precio (€)
<b>berker Q.1, blanco polar</b>	5204 60 89	1	<b>103,74</b>
<b>berker Q.3, blanco polar</b>	5204 60 99	1	<b>103,74</b>



5205 60 89

### Pulsador presencia/pausa

Descripción	Referencia	Emb.	Precio (€)
<b>berker Q.1, blanco polar</b>	5205 60 89	1	<b>102,65</b>
<b>berker Q.3, blanco polar</b>	5205 60 99	1	<b>102,65</b>



5206 60 89

### Pulsador de llamada

Descripción	Referencia	Emb.	Precio (€)
<b>berker Q.1, blanco polar</b>	5206 60 89	1	<b>38,22</b>
<b>berker Q.3, blanco polar</b>	5206 60 99	1	<b>38,22</b>

## Tarjetero hotel electrónico



1640 60 99

### Tarjetero hotel electrónico

Descripción	Referencia	Emb.	Precio (€)
<b>Blanco polar</b>	1640 60 99	1	<b>89,65</b>
<b>Antracita</b>	1640 60 96	1	<b>93,54</b>
<b>Aluminio</b>	1640 60 94	1	<b>93,54</b>

## TV / Audio / Video



33 1532 60 89

## Toma 3 x Cinch/S-Video

Descripción	Referencia	Emb.	Precio (€)
<b>Blanco polar</b>	33 1532 60 89	10	<b>157,22</b>
<b>Antracita</b>	33 1532 60 86	10	<b>138,85</b>
<b>Aluminio</b>	33 1532 60 84	10	<b>138,85</b>



33 1540 60 89

## Toma VGA

Descripción	Referencia	Emb.	Precio (€)
<b>Blanco polar</b>	33 1540 60 89	10	<b>78,71</b>
<b>Antracita</b>	33 1540 60 86	10	<b>111,27</b>
<b>Aluminio</b>	33 1540 60 84	10	<b>111,27</b>



33 1541 60 89

## Toma VGA con terminales a tornillo y mordaza

Descripción	Referencia	Emb.	Precio (€)
<b>Blanco polar</b>	33 1541 60 89	10	<b>78,71</b>
<b>Antracita</b>	33 1541 60 86	10	<b>114,66</b>
<b>Aluminio</b>	33 1541 60 84	10	<b>114,66</b>



33 1539 60 89

## Toma USB / audio 3,5 mm

Descripción	Referencia	Emb.	Precio (€)
<b>Antracita</b>	33 1539 60 86	10	<b>92,31</b>



33 1542 60 89

## Toma alta definición

Descripción	Referencia	Emb.	Precio (€)
<b>Blanco polar</b>	33 1542 60 89	10	<b>179,71</b>
<b>Antracita</b>	33 1542 60 86	10	<b>158,27</b>
<b>Aluminio</b>	33 1542 60 84	10	<b>158,27</b>



33 1543 60 89

## Toma alta definición con conexión 90°

Descripción	Referencia	Emb.	Precio (€)
<b>Blanco polar</b>	33 1543 60 89	10	<b>179,71</b>
<b>Antracita</b>	33 1543 60 86	10	<b>158,27</b>
<b>Aluminio</b>	33 1543 60 84	10	<b>158,27</b>



1412 19 09

## Tapa central para conectores redondos XLR serie D

Descripción	Referencia	Emb.	Precio (€)
<b>Blanco polar</b>	1412 19 09	10	<b>11,16</b>
<b>Antracita</b>	1412 16 06	10	<b>13,99</b>



1196 60 89

## Tapa central para toma altavoz y conector mini

Descripción	Referencia	Emb.	Precio (€)
<b>Blanco polar</b>	1196 60 89	10	<b>7,92</b>
<b>Antracita</b>	1196 60 86	10	<b>9,61</b>
<b>Aluminio</b>	1196 60 84	10	<b>9,61</b>



1203 60 89

## Tapa central para toma TV 2 o 3 salidas

Descripción	Referencia	Emb.	Precio (€)
<b>Blanco polar</b>	1203 60 89	10	<b>5,89</b>
<b>Antracita</b>	1203 60 86	10	<b>9,61</b>
<b>Aluminio</b>	1203 60 84	10	<b>9,61</b>



1484 19 09

## Tapa central para toma TV 4 salidas

Descripción	Referencia	Emb.	Precio (€)
<b>Blanco polar</b>	1484 19 09	10	<b>5,02</b>
<b>Antracita</b>	1484 16 06	10	<b>8,35</b>

- Utilizar sólo con marcos intermedios de la serie correspondiente
- Tomas TV de Ankaro, Astro, Axing, Delta, Schwaiger



1483 19 09

## Tapa central para toma TV 4 salidas con tornillo

Descripción	Referencia	Emb.	Precio (€)
<b>Blanco polar</b>	1483 19 09	10	<b>5,12</b>
<b>Antracita</b>	1483 16 06	10	<b>8,35</b>

- Utilizar sólo con marcos intermedios de la serie correspondiente
- Tomas TV de Hirschmann

## Marcos intermedios



1109 60 79

## Anillo adaptador para tapa 50 x 50 mm

Descripción	Referencia	Emb.	Precio (€)
<b>Blanco polar</b>	1109 60 79	10	<b>3,10</b>
<b>Antracita</b>	1109 60 76	10	<b>6,22</b>
<b>Aluminio</b>	1109 60 74	10	<b>6,22</b>



1109 60 89

## Marco intermedio para tapas centrales

Descripción	Referencia	Emb.	Precio (€)
<b>Blanco polar</b>	1109 60 89	10	<b>3,10</b>
<b>Antracita</b>	1109 60 86	10	<b>5,84</b>
<b>Aluminio</b>	1109 60 84	10	<b>5,84</b>



1905 00 69

## Portaetiquetas para marco intermedio

Descripción	Referencia	Emb.	Precio (€)
<b>Blanco polar, mate</b>	1905 00 69	10	<b>4,63</b>

## Tapa salida de cables



1019 60 89

## Tapa central para salida de cable

Descripción	Referencia	Emb.	Precio (€)
<b>Blanco polar</b>	1019 60 89	10	<b>8,07</b>
<b>Antracita</b>	1019 60 86	10	<b>9,80</b>
<b>Aluminio</b>	1019 60 84	10	<b>9,80</b>

## Tapas altavoz / datos / telecomunicaciones



1033 60 89

## Tapa central para toma TAE y altavoz

Descripción	Referencia	Emb.	Precio (€)
<b>Blanco polar</b>	1033 60 89	10	<b>4,17</b>
<b>Antracita</b>	1033 60 86	10	<b>9,80</b>
<b>Aluminio</b>	1033 60 84	10	<b>9,80</b>



1407 60 89

## Tapa central para toma teléfono / red

Descripción	Referencia	Emb.	Precio (€)
<b>Blanco polar</b>	1407 60 89	10	<b>6,39</b>
<b>Antracita</b>	1407 60 86	10	<b>9,61</b>
<b>Aluminio</b>	1407 60 84	10	<b>9,61</b>



1409 60 89

### Tapa central para toma teléfono / red doble

Descripción	Referencia	Emb.	Precio (€)
<b>Blanco polar</b>	1409 60 89	10	<b>6,39</b>
<b>Antracita</b>	1409 60 86	10	<b>9,61</b>
<b>Aluminio</b>	1409 60 84	10	<b>9,61</b>



1427 19 09

### Tapa central para 3 módulos MINI-COM

Descripción	Referencia	Emb.	Precio (€)
<b>Blanco polar</b>	1427 19 09	10	<b>19,94</b>
<b>Antracita</b>	1427 16 06	10	<b>22,37</b>



1463 19 09

### Tapa central para jack modular AMP

Descripción	Referencia	Emb.	Precio (€)
<b>Blanco polar</b>	1463 19 09	10	<b>26,95</b>
<b>Antracita</b>	1463 16 06	10	<b>25,17</b>

• Utilizar sólo con marcos intermedios de la serie correspondiente



1464 19 09

### Tapa central para jack modular Krone

Descripción	Referencia	Emb.	Precio (€)
<b>Blanco polar</b>	1464 19 09	10	<b>26,95</b>
<b>Antracita</b>	1464 16 06	10	<b>25,17</b>

• Utilizar sólo con marcos intermedios de la serie correspondiente



1170 60 89

### Tapa central protección suciedad y portaetiquetas

Descripción	Referencia	Emb.	Precio (€)
<b>Blanco polar</b>	1170 60 89	10	<b>9,99</b>
<b>Antracita</b>	1170 60 86	10	<b>15,41</b>
<b>Aluminio</b>	1170 60 84	10	<b>15,41</b>



1181 60 89

### Tapa central protección suciedad y portaetiquetas doble

Descripción	Referencia	Emb.	Precio (€)
<b>Blanco polar</b>	1181 60 89	10	<b>11,97</b>
<b>Antracita</b>	1181 60 86	10	<b>17,47</b>
<b>Aluminio</b>	1181 60 84	10	<b>17,47</b>



1494 19 09

### Tapa central para AMP-ACO con portaetiquetas

Descripción	Referencia	Emb.	Precio (€)
<b>Blanco polar, mate</b>	1494 19 09	10	<b>5,78</b>

• Utilizar sólo con marcos intermedios de la serie correspondiente



1495 19 09

### Tapa central para AMP-ACO con portaetiquetas

Descripción	Referencia	Emb.	Precio (€)
<b>Blanco polar, mate</b>	1495 19 09	10	<b>9,69</b>

• Utilizar sólo con marcos intermedios de la serie correspondiente

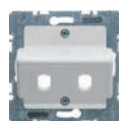

1492 19 09

### Tapa central para acopladores de fibra óptica Simplex ST

Descripción	Referencia	Emb.	Precio (€)
<b>Blanco polar, mate</b>	1492 19 09	10	<b>23,97</b>

• Utilizar sólo con marcos intermedios de la serie correspondiente



1480 19 09

### Tapa central para acopladores de fibra óptica Duplex SC

Descripción	Referencia	Emb.	Precio (€)
<b>Blanco polar, mate</b>	1480 19 09	10	<b>23,97</b>

• Utilizar sólo con marcos intermedios de la serie correspondiente



1411 19 09

### Tapa central para conector 1 D-subminiatura

<b>Blanco polar</b>	1411 19 09	10	<b>9,64</b>
---------------------	------------	----	-------------

• Utilizar sólo con marcos intermedios de la serie correspondiente



1470 19 09

### Tapa central para conector 2 D-subminiatura

Descripción	Referencia	Emb.	Precio (€)
<b>Blanco polar</b>	1470 19 09	10	<b>20,50</b>

• Utilizar sólo con marcos intermedios de la serie correspondiente

## Tapa toma USB de carga



68 1033 60 89

### Tapa toma USB de carga

Descripción	Referencia	Emb.	Precio (€)
<b>Blanco polar</b>	68 1033 60 89	10	<b>5,07</b>
<b>Antracita</b>	68 1033 60 86	10	<b>7,56</b>
<b>Aluminio</b>	68 1033 60 84	10	<b>7,56</b>

## Unidades de señalización y gestión



1431 19 09

### Toma transmisión y control dispositivos 18,8 mm

Descripción	Referencia	Emb.	Precio (€)
<b>Blanco polar, mate</b>	1431 19 09	10	<b>11,74</b>
<b>Antracita</b>	1431 16 06	10	<b>14,89</b>

• Utilizar sólo con marcos intermedios de la serie correspondiente

## Tapas sistemas hospitalarios



1403 19 09

### Tapa toma doble equipotencial

Descripción	Referencia	Emb.	Precio (€)
<b>Blanco polar</b>	1403 19 09	10	<b>9,75</b>
<b>Antracita</b>	1403 16 06	10	<b>12,84</b>



1474 19 09

### Tapa para toma 6 polos / timbre

Descripción	Referencia	Emb.	Precio (€)
<b>Blanco polar</b>	1474 19 09	10	<b>9,11</b>
<b>Antracita</b>	1474 16 06	10	<b>10,78</b>
<b>Aluminio</b>	1474 14 04	10	<b>14,52</b>

• Utilizar sólo con marcos intermedios correspondientes para BBH01:  
1474 19 09 - Blanco polar  
1474 16 06 - Antracita



# berker K.1

Menos es más - berker K.1 perfeccionó el arte del minimalismo. Ello lo convierte en la elección acertada para todos los interiores clásicos e intemporales.



design  
award  
china





# berker K.5

Los claros contornos y la calidad del material determinan el aspecto cultivado en todo su conjunto del berker K.5. Tal vez un excelente ejemplo de ello: berker K.5 en elegante aluminio.

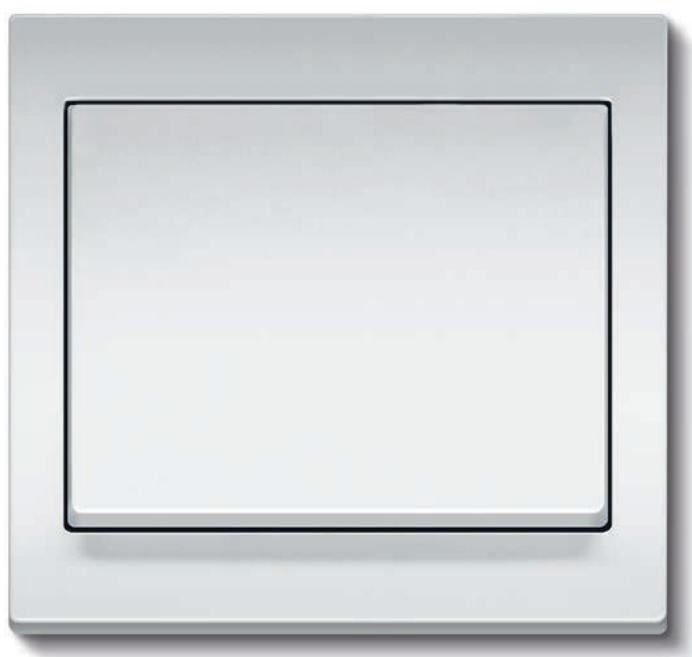

**DESIGN PLUS**  
AWARD WINNER 2005



DESIGNPREIS  
2007  
NOMINIERT



**GOLD  
AWARD**  
Product  
2012



## Marcos



1313 70 09

## Marcos K.1 blanco polar, brillo

Descripción	Referencia	Emb.	Precio (€)
<b>1 elemento</b>	1313 70 09	10	<b>2,38</b>
<b>2 elementos vertical</b>	1323 70 09	2	<b>4,60</b>
<b>3 elementos vertical</b>	1333 70 09	2	<b>6,84</b>
<b>4 elementos vertical</b>	1343 70 09	2	<b>9,35</b>
<b>5 elementos vertical</b>	1353 70 09	2	<b>15,20</b>
<b>2 elementos horizontal</b>	1363 70 09	2	<b>4,60</b>
<b>3 elementos horizontal</b>	1373 70 09	2	<b>6,84</b>
<b>4 elementos horizontal</b>	1383 70 09	2	<b>9,35</b>
<b>5 elementos horizontal</b>	1393 70 09	2	<b>15,20</b>

• Para protección IP44 utilizar ref. 1010 7..



1313 70 06

## Marcos K.1 antracita

Descripción	Referencia	Emb.	Precio (€)
<b>1 elemento</b>	1313 70 06	10	<b>4,60</b>
<b>2 elementos vertical</b>	1323 70 06	10	<b>7,00</b>
<b>3 elementos vertical</b>	1333 70 06	2	<b>10,67</b>
<b>4 elementos vertical</b>	1343 70 06	2	<b>17,28</b>
<b>5 elementos vertical</b>	1353 70 06	2	<b>24,17</b>
<b>2 elementos horizontal</b>	1363 70 06	10	<b>7,00</b>
<b>3 elementos horizontal</b>	1373 70 06	2	<b>10,67</b>
<b>4 elementos horizontal</b>	1383 70 06	2	<b>17,28</b>
<b>5 elementos horizontal</b>	1393 70 06	2	<b>24,17</b>

• Para protección IP44 utilizar ref. 1010 7..



1313 70 04

## Marcos K.5 acero

Descripción	Referencia	Emb.	Precio (€)
<b>1 elemento</b>	1313 70 04	10	<b>12,58</b>
<b>2 elementos vertical</b>	1323 70 04	2	<b>20,17</b>
<b>3 elementos vertical</b>	1333 70 04	2	<b>43,74</b>
<b>4 elementos vertical</b>	1343 70 04	2	<b>50,28</b>
<b>5 elementos vertical</b>	1353 70 04	2	<b>79,08</b>
<b>2 elementos horizontal</b>	1363 70 04	2	<b>20,17</b>
<b>3 elementos horizontal</b>	1373 70 04	2	<b>43,74</b>
<b>4 elementos horizontal</b>	1383 70 04	2	<b>50,28</b>
<b>5 elementos horizontal</b>	1393 70 04	2	<b>79,08</b>

• Para protección IP44 utilizar ref. 1010 ..



1313 70 03

## Marcos K.5 aluminio

Descripción	Referencia	Emb.	Precio (€)
<b>1 elemento</b>	1313 70 03	10	<b>12,58</b>
<b>2 elementos vertical</b>	1323 70 03	2	<b>20,17</b>
<b>3 elementos vertical</b>	1333 70 03	2	<b>43,74</b>
<b>4 elementos vertical</b>	1343 70 03	2	<b>50,28</b>
<b>5 elementos vertical</b>	1353 70 03	2	<b>79,08</b>
<b>2 elementos horizontal</b>	1363 70 03	2	<b>20,17</b>
<b>3 elementos horizontal</b>	1373 70 03	2	<b>43,74</b>
<b>4 elementos horizontal</b>	1383 70 03	2	<b>50,28</b>
<b>5 elementos horizontal</b>	1393 70 03	2	<b>79,08</b>

• Para protección IP44 utilizar ref. 1010 ..

## Marcos para teclados KNX



1309 70 09

Descripción	Referencia	Emb.	Precio (€)
<b>Marco K.1, blanco polar, brillo</b>	1309 70 09	1	<b>9,04</b>
<b>Marco K.1, antracita</b>	1309 70 06	1	<b>11,24</b>
<b>Marco K.5, acero</b>	1309 70 04	1	<b>19,07</b>
<b>Marco K.5, aluminio</b>	1309 70 03	1	<b>19,07</b>

• No es válido para montajes en superficie  
• Montaje vertical

**Nota:** En instalaciones en paredes de tabique hueco, se recomienda dejar la caja de empotrar enrasada con la pared con el fin de que la instalación de nuestras series de mecanismos se realice de la manera que se han diseñado. Recomendamos el uso de una sierra de corona con avellanador.

## Cajas para montaje en superficie

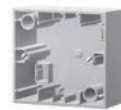

1041 70 09

## Caja montaje en superficie 1 elemento

Descripción	Referencia	Emb.	Precio (€)
<b>Blanco polar, brillo</b>	1041 70 09	10	<b>19,23</b>
<b>Antracita</b>	1041 70 06	10	<b>19,47</b>
<b>Acero</b>	1041 70 04	10	<b>23,28</b>
<b>Aluminio</b>	1041 70 03	10	<b>23,28</b>

• Profundidad instalación 36 mm



1042 70 09

## Caja montaje en superficie 2 elementos vertical

Descripción	Referencia	Emb.	Precio (€)
<b>Blanco polar, brillo</b>	1042 70 09	2	<b>29,14</b>
<b>Antracita</b>	1042 70 06	5	<b>30,67</b>
<b>Acero</b>	1042 70 04	5	<b>33,31</b>
<b>Aluminio</b>	1042 70 03	5	<b>33,31</b>

• Profundidad instalación 36 mm



1043 70 09

## Caja montaje en superficie 3 elementos vertical

Descripción	Referencia	Emb.	Precio (€)
<b>Blanco polar, brillo</b>	1043 70 09	5	<b>45,98</b>
<b>Antracita</b>	1043 70 06	5	<b>48,00</b>
<b>Acero</b>	1043 70 04	5	<b>45,98</b>
<b>Aluminio</b>	1043 70 03	5	<b>45,98</b>

• Profundidad instalación 36 mm



1052 70 09

## Caja montaje en superficie 2 elementos horizontal

Descripción	Referencia	Emb.	Precio (€)
<b>Blanco polar, brillo</b>	1052 70 09	5	<b>29,14</b>
<b>Antracita</b>	1052 70 06	5	<b>30,67</b>
<b>Acero</b>	1052 70 04	5	<b>33,31</b>
<b>Aluminio</b>	1052 70 03	5	<b>33,31</b>

• Profundidad instalación 36 mm



1053 70 04

## Caja montaje en superficie 3 elementos horizontal

Descripción	Referencia	Emb.	Precio (€)
<b>Blanco polar, brillo</b>	1053 70 09	5	<b>45,98</b>
<b>Antracita</b>	1053 70 06	5	<b>48,00</b>
<b>Acero</b>	1053 70 04	5	<b>45,98</b>
<b>Aluminio</b>	1053 70 03	5	<b>45,98</b>

• Profundidad instalación 36 mm

## Kits de sellado IP44 K.x / Q.x



1010 72 00

## Para tomas de corriente y tapa central

Descripción	Referencia	Emb.	Precio (€)
<b>Transparente</b>	1010 72 00	1	<b>8,63</b>



1010 71 00

## Para tecla interruptor y pulsador

Descripción	Referencia	Emb.	Precio (€)
<b>Transparente</b>	1010 71 00	1	<b>14,19</b>



1010 70 00

## Para interruptor de llave/ pulsador de llave

Descripción	Referencia	Emb.	Precio (€)
<b>Transparente</b>	1010 70 00	1	<b>20,55</b>

## Tomas de corriente



1719 70 09

### Tapa para SCHUKO

Descripción	Referencia	Emb.	Precio (€)
<b>Blanco polar</b>	1719 70 09	10	<b>5,73</b>
<b>Antracita</b>	1719 70 06	10	<b>5,90</b>
<b>Acero</b>	1719 70 04	10	<b>10,40</b>
<b>Aluminio</b>	1719 70 03	10	<b>10,40</b>
<b>Rojo</b>	1719 70 15	10	<b>6,21</b>

- Añadir mecanismo ref. 714134
- Con protección infantil



1720 72 09

### Tapa para SCHUKO con tapa articulada

Descripción	Referencia	Emb.	Precio (€)
<b>Blanco polar</b>	1720 72 09	10	<b>14,65</b>
<b>Antracita</b>	1720 72 06	10	<b>14,92</b>
<b>Acero</b>	1720 72 04	10	<b>23,32</b>
<b>Aluminio</b>	1720 72 03	10	<b>23,32</b>

- Añadir mecanismo ref. 714134



73 4135 70 09

### Toma SCHUKO completa

Descripción	Referencia	Emb.	Precio (€)
<b>Blanco polar</b>	73 4135 70 09	10	<b>10,82</b>

- Incluye mecanismo ref. 7141 34 y tapa ref. 1719 70 09



4803 70 09

### Toma SCHUKO con USB 2xA

Descripción	Referencia	Emb.	Precio (€)
<b>Blanco polar, brillo</b>	4803 70 09	10	<b>83,52</b>
<b>Antracita</b>	4803 70 06	1	<b>86,73</b>
<b>Acero</b>	4803 70 04	1	<b>90,01</b>
<b>Aluminio</b>	4803 70 03	1	<b>90,01</b>

- 16A, 230 V~
- USB: 2x USB tipo A 5 V 2,4 A
- Espacio reducido para cableado
- Apta para cable flexible



4804 70 09

### Toma SCHUKO con USB A+C

Descripción	Referencia	Emb.	Precio (€)
<b>Blanco polar, brillo</b>	4804 70 09	10	<b>92,61</b>
<b>Antracita</b>	4804 70 06	10	<b>93,94</b>
<b>Acero</b>	4804 70 04	10	<b>95,40</b>
<b>Aluminio</b>	4804 70 03	10	<b>95,40</b>

- 16A, 230 V~
- USB: USB tipo A + USB tipo C
- Espacio reducido para cableado
- Apta para cable flexible



4738 70 09

### Toma SCHUKO con portaetiquetas

Descripción	Referencia	Emb.	Precio (€)
<b>Blanco polar, brillo</b>	4738 70 09	10	<b>17,69</b>
<b>Antracita</b>	4738 70 06	10	<b>18,38</b>
<b>Acero</b>	4738 70 04	10	<b>21,36</b>
<b>Aluminio</b>	4738 70 03	10	<b>21,36</b>

- 16A, 250 V~
- Con protección infantil
- Etiquetas de 6 mm alto



4110 70 09

### Toma SCHUKO con indicador y portaetiquetas

Descripción	Referencia	Emb.	Precio (€)
<b>Blanco polar, brillo</b>	4110 70 09	10	<b>49,97</b>

- 16A, 250 V~
- Lámpara de Neón 1,5mA
- Con protección infantil
- Etiquetas de 6 mm alto
- Conexión tornillos



4109 70 09

### Toma SCHUKO con LED de orientación

Descripción	Referencia	Emb.	Precio (€)
<b>Blanco polar, brillo</b>	4109 70 09	10	<b>98,03</b>
<b>Antracita</b>	4109 70 06	10	<b>100,77</b>
<b>Acero</b>	4109 70 04	10	<b>101,05</b>
<b>Aluminio</b>	4109 70 03	10	<b>102,56</b>

- 16A, 250 V~
- Con protección infantil
- Conexión tornillos

## Teclas



1405 70 09

### Tecla

Descripción	Referencia	Emb.	Precio (€)
<b>Blanco polar, brillo</b>	1405 70 09	10	<b>3,08</b>
<b>Antracita</b>	1405 70 06	10	<b>8,52</b>
<b>Acero</b>	1405 70 04	10	<b>8,66</b>
<b>Aluminio</b>	1405 70 03	10	<b>8,66</b>



1426 70 09

### Tecla con portaetiquetas

Descripción	Referencia	Emb.	Precio (€)
<b>Blanco polar, brillo</b>	1426 70 09	10	<b>12,13</b>
<b>Antracita</b>	1426 70 06	10	<b>12,58</b>
<b>Acero</b>	1426 70 04	10	<b>12,72</b>
<b>Aluminio</b>	1426 70 03	10	<b>12,72</b>

- Etiquetas de 6 mm alto



1415 70 09

### Tecla con 5 indicadores luminosos

Descripción	Referencia	Emb.	Precio (€)
<b>Blanco polar, brillo</b>	1415 70 09	10	<b>7,11</b>
<b>Antracita</b>	1415 70 06	10	<b>10,13</b>
<b>Acero</b>	1415 70 04	10	<b>13,97</b>
<b>Aluminio</b>	1415 70 03	10	<b>13,97</b>



1415 71 09

### Tecla con 5 indicadores luminosos y portaetiquetas

Descripción	Referencia	Emb.	Precio (€)
<b>Blanco polar, brillo</b>	1415 71 09	10	<b>13,23</b>
<b>Antracita</b>	1415 71 06	10	<b>13,93</b>
<b>Acero</b>	1415 71 04	10	<b>14,19</b>
<b>Aluminio</b>	1415 71 03	10	<b>18,13</b>

- Etiquetas de 6 mm alto



1496 70 09

### Tecla con 5 indicadores luminosos y portaetiquetas grande

Descripción	Referencia	Emb.	Precio (€)
<b>Blanco polar, brillo</b>	1496 70 09	10	<b>13,38</b>
<b>Antracita</b>	1496 70 06	10	<b>13,93</b>
<b>Acero</b>	1496 70 04	10	<b>14,19</b>
<b>Aluminio</b>	1496 70 03	10	<b>14,19</b>

- Portaetiquetas 49,5 x 20,3 mm
- Etiquetas de 29 mm alto

**Tecla con "0"**

Descripción	Referencia	Emb.	Precio (€)
<b>Blanco polar, brillo</b>	1425 71 09	10	<b>5,57</b>
<b>Antracita</b>	1425 71 06	10	<b>10,13</b>
<b>Acero</b>	1425 71 04	10	<b>10,13</b>
<b>Aluminio</b>	1425 71 03	10	<b>10,13</b>

1425 71 09

**Tecla con "0" e indicador luminoso**

Descripción	Referencia	Emb.	Precio (€)
<b>Blanco polar, brillo</b>	1417 71 09	10	<b>7,11</b>
<b>Antracita</b>	1417 71 06	10	<b>11,50</b>
<b>Acero</b>	1417 71 04	10	<b>11,62</b>
<b>Aluminio</b>	1417 71 03	10	<b>11,62</b>

1417 71 09

**Interruptor rotativo**

Descripción	Referencia	Emb.	Precio (€)
<b>Blanco polar, brillo</b>	1150 71 09	1	<b>19,36</b>
<b>Antracita</b>	1150 71 06	1	<b>20,67</b>
<b>Acero</b>	1150 71 04	1	<b>21,62</b>

1150 71 06

**Tecla doble**

Descripción	Referencia	Emb.	Precio (€)
<b>Blanco polar, brillo</b>	1435 70 09	10	<b>8,21</b>
<b>Antracita</b>	1435 70 06	10	<b>12,03</b>
<b>Acero</b>	1435 70 04	10	<b>12,17</b>
<b>Aluminio</b>	1435 70 03	10	<b>21,63</b>

1435 70 09

**Tecla doble con indicador luminoso**

Descripción	Referencia	Emb.	Precio (€)
<b>Blanco polar, brillo</b>	1437 70 09	10	<b>9,91</b>
<b>Antracita</b>	1437 70 06	10	<b>15,00</b>
<b>Acero</b>	1437 70 04	10	<b>15,00</b>
<b>Aluminio</b>	1437 70 03	10	<b>15,00</b>

1437 70 09

**Tecla para mecanismo triple ON/OFF**

Descripción	Referencia	Emb.	Precio (€)
<b>Blanco polar, brillo</b>	1465 70 09	10	<b>23,01</b>
<b>Antracita</b>	1465 70 06	10	<b>14,87</b>
<b>Acero</b>	1465 70 04	10	<b>22,54</b>

1465 70 09

- Etiquetas de 6 mm. alto

**Tecla doble persiana**

Descripción	Referencia	Emb.	Precio (€)
<b>Blanco polar, brillo</b>	1435 71 09	10	<b>9,74</b>
<b>Antracita</b>	1435 71 06	10	<b>15,00</b>
<b>Acero</b>	1435 71 04	10	<b>15,00</b>
<b>Aluminio</b>	1435 71 03	10	<b>15,00</b>

1435 71 09

**Teclas sin barreras****Tecla simple con 5 lentes**

Descripción	Referencia	Emb.	Precio (€)
<b>Blanco polar, brillo</b>	1661 71 09	10	<b>14,77</b>

1661 71 09

**Tecla simple con lente rojo y símbolo luz en relieve**

Descripción	Referencia	Emb.	Precio (€)
<b>Blanco polar, brillo</b>	1651 71 09	10	<b>13,65</b>

1651 71 09

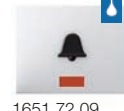
**Tecla simple con lente rojo y símbolo campana en relieve**

Descripción	Referencia	Emb.	Precio (€)
<b>Blanco polar, brillo</b>	1651 72 09	10	<b>13,65</b>

1651 72 09

**Tecla simple con lente rojo y símbolo llave en relieve**

Descripción	Referencia	Emb.	Precio (€)
<b>Blanco polar, brillo</b>	1651 73 09	10	<b>13,65</b>

1651 73 09

- Sin barreras basado en DIN 18025

**Tapas****Tapa tarjetero de hotel con indicador luminoso**

Descripción	Referencia	Emb.	Precio (€)
<b>Blanco polar, brillo</b>	1641 71 09	10	<b>22,85</b>
<b>Antracita</b>	1641 71 06	10	<b>38,51</b>
<b>Acero</b>	1641 71 04	10	<b>42,30</b>
<b>Aluminio</b>	1641 71 03	10	<b>42,30</b>

1641 71 09

- Mecanismo ref.: 5051 02, 5051 03, 5052 01, 5056 01

**Tapa interruptor/pulsador tirador**

Descripción	Referencia	Emb.	Precio (€)
<b>Blanco polar, brillo</b>	1147 70 09	10	<b>9,20</b>
<b>Antracita</b>	1147 70 06	10	<b>10,28</b>

1147 70 09

**Tapa para interruptor 3 posiciones con mando rotativo**

Descripción	Referencia	Emb.	Precio (€)
<b>Sin posición 0</b>			
<b>Blanco polar, brillo</b>	1088 71 09 00	1	<b>14,64</b>
<b>Antracita</b>	1088 71 06 00	1	<b>18,87</b>
<b>Acero</b>	1088 71 04 00	1	<b>19,86</b>
<b>Aluminio</b>	1088 71 03 00	1	<b>19,86</b>
<b>Con posición neutra</b>			
<b>Blanco polar, brillo</b>	1087 71 09 00	1	<b>14,64</b>
<b>Antracita</b>	1087 71 06 00	1	<b>18,87</b>
<b>Acero</b>	1087 71 04 00	1	<b>19,86</b>
<b>Aluminio</b>	1087 71 03 00	1	<b>19,86</b>

1088 71 09 00

**Tapa para interruptor/pulsador rotativo para persianas**

Descripción	Referencia	Emb.	Precio (€)
<b>Blanco polar, brillo</b>	1077 71 09 00	1	<b>12,50</b>
<b>Antracita</b>	1077 71 06 00	1	<b>18,87</b>
<b>Acero</b>	1077 71 04 00	1	<b>19,86</b>
<b>Aluminio</b>	1077 71 03 00	1	<b>19,86</b>

1077 71 09 00



**Tapa con cerradura para interruptor de llave de persianas**

Descripción	Referencia	Emb.	Precio (€)
<b>Blanco polar, brillo</b>	1079 71 09 00	1	<b>85,40</b>
<b>Antracita</b>	1079 71 06 00	1	<b>89,18</b>
<b>Acero</b>	1079 71 04 00	1	<b>89,86</b>
<b>Aluminio</b>	1079 71 03 00	1	<b>89,86</b>



**Llave extraíble en las 3 posiciones**

Descripción	Referencia	Emb.	Precio (€)
<b>Blanco polar, brillo</b>	1079 72 09 00	1	<b>85,40</b>
<b>Antracita</b>	1079 72 06 00	1	<b>89,18</b>
<b>Acero</b>	1079 72 04 00	1	<b>89,86</b>
<b>Aluminio</b>	1079 72 03 00	1	<b>89,86</b>

- Función bloqueo presión



**Tapa con cerradura para interruptor de llave de persianas**

Descripción	Referencia	Emb.	Precio (€)
<b>Blanco polar, brillo</b>	1079 73 09 00	1	<b>85,40</b>
<b>Antracita</b>	1079 73 06 00	1	<b>89,18</b>
<b>Acero</b>	1079 73 04 00	1	<b>89,86</b>
<b>Aluminio</b>	1079 73 03 00	1	<b>89,86</b>

- Función sólo pulsador
- Llave extraíble en posición media



**Tapa para interruptor / pulsador de llave de persianas**

Descripción	Referencia	Emb.	Precio (€)
<b>Blanco polar, brillo</b>	1504 71 09 10	10	<b>20,33</b>
<b>Antracita</b>	1504 71 06 10	10	<b>20,00</b>
<b>Acero</b>	1504 71 04 10	10	<b>26,22</b>
<b>Aluminio</b>	1504 71 03 10	10	<b>26,22</b>

- Con símbolo



Descripción	Referencia	Emb.	Precio (€)
<b>Blanco polar, brillo</b>	1505 70 09 10	10	<b>20,33</b>
<b>Antracita</b>	1505 70 06 10	10	<b>20,00</b>
<b>Acero</b>	1505 70 04 10	10	<b>26,22</b>
<b>Aluminio</b>	1505 70 03 10	10	<b>26,22</b>

- Sin símbolo

**Tapas ciegas**



**Tapa ciega**

Descripción	Referencia	Emb.	Precio (€)
<b>Sin garras</b>			
<b>Blanco polar, brillo</b>	1045 70 09 20	20	<b>13,38</b>
<b>Antracita</b>	1045 70 06 20	20	<b>15,00</b>
<b>Acero</b>	1045 70 04 20	20	<b>19,07</b>
<b>Aluminio</b>	1045 70 03 20	20	<b>19,07</b>

**Con base y garras**

<b>Blanco polar, brillo</b>	67 1045 70 09 10	10	<b>13,65</b>
<b>Antracita</b>	67 1045 70 06 10	10	<b>15,30</b>
<b>Acero</b>	67 1045 70 04 10	10	<b>19,45</b>
<b>Aluminio</b>	67 1045 70 03 10	10	<b>19,45</b>



**Tapa ciega atornillada**

Descripción	Referencia	Emb.	Precio (€)
<b>Blanco polar, brillo</b>	1045 71 09 20	20	<b>16,59</b>
<b>Antracita</b>	1045 71 06 20	20	<b>17,99</b>

1045 71 09

**Señalización**



**Tapa central para piloto / pulsador, lámpara E10**

Descripción	Referencia	Emb.	Precio (€)
<b>Blanco polar, brillo</b>	1165 70 09 10	10	<b>7,39</b>
<b>Antracita</b>	1165 70 06 10	10	<b>8,24</b>
<b>Acero</b>	1165 70 04 10	10	<b>12,03</b>
<b>Aluminio</b>	1165 70 03 10	10	<b>12,03</b>



**Tapa central para piloto, lámpara E14**

Descripción	Referencia	Emb.	Precio (€)
<b>Blanco polar, brillo</b>	1167 70 09 10	10	<b>5,43</b>
<b>Antracita</b>	1167 70 06 10	10	<b>8,93</b>
<b>Acero</b>	1167 70 04 10	10	<b>12,72</b>
<b>Aluminio</b>	1167 70 03 10	10	<b>12,72</b>

**Temporizadores**



**Tapa con mando rotativo p/temporizador mecánico**

Descripción	Referencia	Emb.	Precio (€)
<b>Máximo 15 minutos</b>			
<b>Blanco polar, brillo</b>	1634 71 09 1	1	<b>21,60</b>
<b>Antracita</b>	1634 71 06 1	1	<b>21,22</b>
<b>Acero</b>	1634 71 04 1	1	<b>23,78</b>
<b>Aluminio</b>	1634 71 03 1	1	<b>23,78</b>



**Máximo 120 minutos**

<b>Blanco polar, brillo</b>	1635 71 09 1	1	<b>21,60</b>
<b>Antracita</b>	1635 71 06 1	1	<b>21,22</b>
<b>Acero</b>	1635 71 04 1	1	<b>23,78</b>
<b>Aluminio</b>	1635 71 03 1	1	<b>23,78</b>

1635 71 09

**Tapa regulador rotativo**



**Tapa central c/ mando rotativo para regulador rotativo**

Descripción	Referencia	Emb.	Precio (€)
<b>Blanco polar, brillo</b>	1135 70 09 10	10	<b>28,50</b>
<b>Antracita</b>	1135 70 06 10	10	<b>28,68</b>
<b>Acero</b>	1135 70 04 10	10	<b>53,28</b>
<b>Aluminio</b>	1135 70 03 10	10	<b>53,28</b>

1135 70 09

**Tapa control velocidad**



**Tapa central con mando para control velocidad**

Descripción	Referencia	Emb.	Precio (€)
<b>Blanco polar, brillo</b>	1135 72 09 10	10	<b>30,80</b>
<b>Antracita</b>	1135 72 06 10	10	<b>31,07</b>
<b>Acero</b>	1135 72 04 10	10	<b>55,60</b>
<b>Aluminio</b>	1135 72 03 10	10	<b>55,60</b>

1135 72 09

## Llamada emergencia berker K.1 (Marcos incluidos)



5200 70 09

## Kit de llamada de emergencia

Descripción	Referencia	Emb.	Precio (€)
<b>Blanco polar</b>	5200 70 09	1	<b>305,7€</b>



5201 70 09

## Pulsador de confirmación

Descripción	Referencia	Emb.	Precio (€)
<b>Blanco polar</b>	5201 70 09	1	<b>39,31</b>



5202 70 09

## Pulsador de tirador

Descripción	Referencia	Emb.	Precio (€)
<b>Blanco polar</b>	5202 70 09	1	<b>39,31</b>



5203 70 09

## Indicador luminoso

Descripción	Referencia	Emb.	Precio (€)
<b>Blanco polar</b>	5203 70 09	1	<b>156,16</b>



5204 70 09

## Fuente de alimentación

Descripción	Referencia	Emb.	Precio (€)
<b>Blanco polar</b>	5204 70 09	1	<b>104,83</b>



5205 70 09

## Pulsador presencia/pausa

Descripción	Referencia	Emb.	Precio (€)
<b>Blanco polar</b>	5205 70 09	1	<b>103,74</b>



5205 70 09

## Pulsador de llamada

Descripción	Referencia	Emb.	Precio (€)
<b>Blanco polar</b>	5206 70 09	1	<b>39,31</b>

## Termostatos



2030 71 09

## Termostato

Descripción	Referencia	Emb.	Precio (€)
<b>Blanco polar, brillo</b>	2030 71 09	1	<b>121,66</b>
<b>Antracita</b>	2030 71 06	1	<b>128,42</b>
<b>Acero</b>	2030 71 04	1	<b>128,42</b>
<b>Aluminio</b>	2030 71 03	1	<b>128,42</b>



2026 71 09

## Termostato con conmutador

Descripción	Referencia	Emb.	Precio (€)
<b>Blanco polar, brillo</b>	2026 71 09	1	<b>121,66</b>
<b>Antracita</b>	2026 71 06	1	<b>123,01</b>
<b>Acero</b>	2026 71 04	1	<b>128,42</b>
<b>Aluminio</b>	2026 71 03	1	<b>128,42</b>



2034 71 09

## Termostato de suelo radiante

Descripción	Referencia	Emb.	Precio (€)
<b>Blanco polar, brillo</b>	2034 71 09	1	<b>381,78</b>
<b>Antracita</b>	2034 71 06	1	<b>387,58</b>
<b>Acero</b>	2034 71 04	1	<b>399,63</b>
<b>Aluminio</b>	2034 71 03	1	<b>399,63</b>

## Tarjetero hotel electrónico



1641 71 19

## Tarjetero hotel electrónico

Descripción	Referencia	Emb.	Precio (€)
<b>Blanco polar, brillo</b>	1641 71 19	1	<b>95,95</b>
<b>Antracita</b>	1641 71 16	1	<b>99,14</b>
<b>Acero</b>	1641 71 14	1	<b>104,43</b>
<b>Aluminio</b>	1641 71 34	1	<b>104,43</b>

## TV / Audio / Video

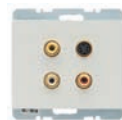

33 1532 70 09

## Toma 3 x Cinch/S-Video

Descripción	Referencia	Emb.	Precio (€)
<b>Blanco polar, brillo</b>	33 1532 70 09	10	<b>168,69</b>
<b>Antracita</b>	33 1532 70 06	10	<b>181,74</b>
<b>Acero</b>	33 1532 70 04	10	<b>191,90</b>
<b>Aluminio</b>	33 1532 70 03	10	<b>191,90</b>



33 1540 70 09

## Toma VGA

Descripción	Referencia	Emb.	Precio (€)
<b>Blanco polar, brillo</b>	33 1540 70 09	10	<b>85,62</b>
<b>Antracita</b>	33 1540 70 06	10	<b>92,86</b>
<b>Acero</b>	33 1540 70 04	10	<b>103,02</b>
<b>Aluminio</b>	33 1540 70 03	10	<b>103,02</b>



33 1541 70 09

## Toma VGA con terminales a tornillo y mordaza

Descripción	Referencia	Emb.	Precio (€)
<b>Blanco polar, brillo</b>	33 1541 70 09	10	<b>85,62</b>
<b>Antracita</b>	33 1541 70 06	10	<b>92,86</b>
<b>Acero</b>	33 1541 70 04	10	<b>103,02</b>
<b>Aluminio</b>	33 1541 70 03	10	<b>103,02</b>



33 1539 70 03

### Toma USB / audio 3,5 mm

Descripción	Referencia	Emb.	Precio (€)
<b>Aluminio</b>	33 1539 70 03	10	<b>130,92</b>



33 1542 70 09

### Toma alta definición

Descripción	Referencia	Emb.	Precio (€)
<b>Blanco polar, brillo</b>	33 1542 70 09	1	<b>192,41</b>
<b>Antracita</b>	33 1542 70 06	1	<b>207,12</b>
<b>Acero</b>	33 1542 70 04	10	<b>217,28</b>
<b>Aluminio</b>	33 1542 70 03	10	<b>217,28</b>



33 1543 70 09

### Toma alta definición con conexión 90°

Descripción	Referencia	Emb.	Precio (€)
<b>Blanco polar, brillo</b>	33 1543 70 09	10	<b>192,41</b>
<b>Antracita</b>	33 1543 70 06	10	<b>207,12</b>
<b>Acero</b>	33 1543 70 04	10	<b>217,28</b>
<b>Aluminio</b>	33 1543 70 03	10	<b>217,28</b>

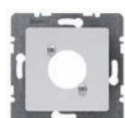

1412 19 09

### Tapa central para conectores redondos XLR serie D

Descripción	Referencia	Emb.	Precio (€)
<b>Blanco polar, brillo</b>	1412 09	10	<b>10,03</b>
<b>Antracita</b>	1412 16 06	10	<b>13,99</b>
<b>Acero</b>	1412 19 09	10	<b>11,16</b>



1184 /0 09

### Tapa central para toma altavoz y conector mini

Descripción	Referencia	Emb.	Precio (€)
<b>Blanco polar, brillo</b>	1184 70 09	10	<b>8,77</b>
<b>Antracita</b>	1184 70 06	10	<b>9,88</b>
<b>Acero</b>	1184 70 04	10	<b>13,93</b>
<b>Aluminio</b>	1184 70 03	10	<b>13,93</b>



1201 70 19

### Tapa central para toma TV 2 ó 3 salidas

Descripción	Referencia	Emb.	Precio (€)
<b>Blanco polar, brillo</b>	1201 70 19	10	<b>6,56</b>
<b>Antracita</b>	1201 70 16	10	<b>9,88</b>
<b>Acero</b>	1201 70 14	10	<b>13,88</b>
<b>Aluminio</b>	1201 70 13	10	<b>13,88</b>



1484 09

### Tapa central para toma TV 4 salidas

Descripción	Referencia	Emb.	Precio (€)
<b>Blanco polar, brillo</b>	1484 09	10	<b>5,12</b>
<b>Antracita</b>	1484 16 06	10	<b>8,35</b>
<b>Acero</b>	1484 04	10	<b>13,36</b>

- Utilizar sólo con marcos intermedios de la serie correspondiente
- Tomas TV de Ankaro, Astro, Axing, Delta, Schwaiger



1483 09

### Tapa central para toma TV 4 salidas con tornillo

Descripción	Referencia	Emb.	Precio (€)
<b>Blanco polar, brillo</b>	1483 09	10	<b>4,75</b>
<b>Antracita</b>	1483 16 06	10	<b>8,35</b>
<b>Acero</b>	1483 04	10	<b>16,57</b>

- Utilizar sólo con marcos intermedios de la serie correspondiente
- Tomas TV de Hirschmann

## Marcos intermedios



1108 71 09

### Anillo adaptador para tapa 50 x 50 mm

Descripción	Referencia	Emb.	Precio (€)
<b>Blanco polar, brillo</b>	1108 71 09	10	<b>3,62</b>
<b>Antracita</b>	1108 71 06	10	<b>5,07</b>
<b>Acero</b>	1108 71 04	10	<b>6,34</b>
<b>Aluminio</b>	1108 71 03	10	<b>6,34</b>



1108 70 09

### Marco intermedio para tapas centrales

Descripción	Referencia	Emb.	Precio (€)
<b>Blanco polar, brillo</b>	1108 70 09	10	<b>3,62</b>
<b>Antracita</b>	1108 70 06	10	<b>5,42</b>
<b>Acero</b>	1108 70 04	10	<b>6,88</b>
<b>Aluminio</b>	1108 70 03	10	<b>6,88</b>



1905 00 69

### Portaetiquetas para marco intermedio

Descripción	Referencia	Emb.	Precio (€)
<b>Blanco polar, brillo</b>	1905 00 69	10	<b>4,63</b>
<b>Acero</b>	1905 70 04	10	<b>7,64</b>
<b>Aluminio</b>	1905 70 03	10	<b>8,04</b>



1154 71 09

### Anillo adaptador con tapa y portaetiquetas para tapa 50 x 50 mm

Descripción	Referencia	Emb.	Precio (€)
<b>Blanco polar, brillo</b>	1154 71 09	10	<b>13,38</b>
<b>Antracita</b>	1154 71 06	10	<b>17,57</b>
<b>Acero</b>	1154 71 04	10	<b>28,55</b>
<b>Aluminio</b>	1154 71 03	10	<b>28,55</b>

## Tapa salida de cables



1005 70 09

### Tapa central para salida de cables

Descripción	Referencia	Emb.	Precio (€)
<b>Blanco polar, brillo</b>	1005 70 09	10	<b>8,37</b>
<b>Antracita</b>	1005 70 06	10	<b>9,88</b>
<b>Acero</b>	1005 70 04	10	<b>19,22</b>
<b>Aluminio</b>	1005 70 03	10	<b>19,22</b>

## Tapas altavoz / datos / telecomunicaciones



1035 70 09

### Tapa central para toma TAE y altavoz

Descripción	Referencia	Emb.	Precio (€)
<b>Blanco polar, brillo</b>	1035 70 09	10	<b>4,45</b>
<b>Antracita</b>	1035 70 06	10	<b>9,88</b>
<b>Acero</b>	1035 70 04	10	<b>13,93</b>
<b>Aluminio</b>	1035 70 03	10	<b>13,93</b>



1458 09

### Tapa central para toma TAE 6/6FFy 6/6NF y altavoz

Descripción	Referencia	Emb.	Precio (€)
<b>Blanco polar, brillo</b>	1458 09	10	<b>4,75</b>
<b>Marrón</b>	1458 01	10	<b>11,04</b>



1407 70 09

### Tapa central para toma teléfono / red

Descripción	Referencia	Emb.	Precio (€)
<b>Blanco polar, brillo</b>	1407 70 09	10	<b>6,95</b>
<b>Antracita</b>	1407 70 06	10	<b>7,84</b>
<b>Acero</b>	1407 70 04	10	<b>11,07</b>
<b>Aluminio</b>	1407 70 03	10	<b>11,07</b>



1468 09

### Tapa central para toma teléfono / red

Descripción	Referencia	Emb.	Precio (€)
<b>Blanco polar, brillo</b>	1468 09	10	<b>3,79</b>
<b>Marrón</b>	1468 01	10	<b>11,62</b>

- Utilizar sólo con marcos intermedios de la serie correspondiente



1409 70 09

### Tapa central para toma teléfono / red doble

Descripción	Referencia	Emb.	Precio (€)
<b>Blanco polar, brillo</b>	1409 70 09	10	<b>8,65</b>
<b>Antracita</b>	1409 70 06	10	<b>9,88</b>
<b>Acero</b>	1409 70 04	10	<b>13,93</b>
<b>Aluminio</b>	1409 70 03	10	<b>13,93</b>



### Tapa central para toma teléfono / red doble

Descripción	Referencia	Emb.	Precio (€)
<b>Blanco polar, brillo</b>	1469 09	10	<b>5,54</b>
<b>Marrón</b>	1469 01	10	<b>11,62</b>

1469 09

- Utilizar sólo con marcos intermedios de la serie correspondiente



### Tapa central con protección de suciedad y portaetiquetas simple

Descripción	Referencia	Emb.	Precio (€)
<b>Blanco polar, brillo</b>	1170 70 09	10	<b>12,95</b>
<b>Antracita</b>	1170 70 06	10	<b>15,68</b>
<b>Acero</b>	1170 70 04	10	<b>19,73</b>
<b>Aluminio</b>	1170 70 03	10	<b>19,73</b>

1170 70 09



### Tapa central con protección de suciedad y portaetiquetas doble

Descripción	Referencia	Emb.	Precio (€)
<b>Blanco polar, brillo</b>	1182 70 09	10	<b>15,75</b>
<b>Antracita</b>	1182 70 06	10	<b>17,70</b>
<b>Acero</b>	1182 70 04	10	<b>22,72</b>
<b>Aluminio</b>	1182 70 03	10	<b>22,72</b>

1182 70 09



### Tapa central para AMP-ACO

Descripción	Referencia	Emb.	Precio (€)
<b>Blanco polar, brillo</b>	1494 09	10	<b>5,27</b>
<b>Antracita</b>	1494 16 06	10	<b>8,35</b>
<b>Acero</b>	1494 19 09	10	<b>5,78</b>

1494 09

- Utilizar sólo con marcos intermedios de la serie correspondiente
- Portaetiquetas no disponible



### Tapa central para AMP-ACO con portaetiquetas

Descripción	Referencia	Emb.	Precio (€)
<b>Blanco polar</b>	1495 19 09	10	<b>9,69</b>

1495 19 09

- Utilizar sólo con marcos intermedios de la serie correspondiente



### Tapa central para acopladores de fibra óptica Simplex ST

Descripción	Referencia	Emb.	Precio (€)
<b>Blanco polar, brillo</b>	1492 09	10	<b>20,43</b>

1492 09

- Utilizar sólo con marcos intermedios de la serie correspondiente



### Tapa central para acopladores de fibra óptica Duplex SC

Descripción	Referencia	Emb.	Precio (€)
<b>Blanco polar, brillo</b>	1480 09	10	<b>21,06</b>

1480 09

- Utilizar sólo con marcos intermedios de la serie correspondiente



### Tapa central para conector 1 D-subminiatura

Descripción	Referencia	Emb.	Precio (€)
<b>Blanco polar, brillo</b>	1411 09	10	<b>9,50</b>

1411 09 09

- Utilizar sólo con marcos intermedios de la serie correspondiente



### Tapa central para conector 2 D-subminiatura

Descripción	Referencia	Emb.	Precio (€)
<b>Blanco polar, brillo</b>	1470 09	10	<b>18,96</b>

1470 19 09

- Utilizar sólo con marcos intermedios de la serie correspondiente

## Tapa toma USB de carga



68 1034 70 09

### Tapa toma USB de carga

Descripción	Referencia	Emb.	Precio (€)
<b>Blanco polar</b>	68 1034 70 09	10	<b>5,57</b>
<b>Antracita</b>	68 1034 70 06	10	<b>9,01</b>
<b>Acero</b>	68 1034 70 04	10	<b>13,25</b>
<b>Aluminio</b>	68 1034 70 03	10	<b>13,25</b>

## Unidades de señalización y gestión

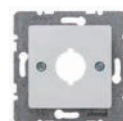

1431 09

### Tapa transmisión y control de dispositivo 18,8 mm

Descripción	Referencia	Emb.	Precio (€)
<b>Blanco polar, brillo</b>	1431 09	10	<b>9,88</b>
<b>Antracita</b>	1431 16 06	10	<b>14,89</b>
<b>Acero</b>	1431 04	10	<b>20,67</b>
<b>Aluminio</b>	1431 70 03	10	<b>13,36</b>

- Utilizar sólo con marcos intermedios de la serie correspondiente

## Tapas sistemas hospitalarios



1403 09

### Tapa toma doble equipotencial

Descripción	Referencia	Emb.	Precio (€)
<b>Blanco polar, brillo</b>	1403 09	10	<b>9,88</b>
<b>Antracita</b>	1403 16 06	10	<b>12,84</b>

- Mecanismo ref.: 1061



1474 09

### Tapa para toma 6 polos/ Timbre

Descripción	Referencia	Emb.	Precio (€)
<b>Blanco polar, brillo</b>	1474 09	10	<b>8,35</b>
<b>Antracita</b>	1474 16 06	10	<b>10,78</b>
<b>Acero</b>	1474 04	10	<b>25,92</b>

- Utilizar sólo con marcos intermedios correspondientes para BBH01:

1108 70 09 - Blanco polar brillo  
 1108 70 06 - Antracita  
 1108 70 04 - Acero  
 1108 70 03 - Aluminio

# K.1

## El arte del minimalismo

berker K.1 es la elección acertada para todos los interiores clásicos e intemporales. Mediante su lenguaje de formas perfilado y anguloso, esta serie añade siempre un toque propio. Un clásico moderno que personifica la calidad y seguridad en el estilo.

[hager.es/berker](http://hager.es/berker)



:hager



# berker R.1

berker R.1 interpreta el radio de una forma radicalmente nueva y única.

Las novedosas superficies berker R.1 son tan puras y refrescantes como su diseño: hormigón, cuero, madera, pizarra y fibra acrílica.



reddot design award  
winner 2013



materialPREIS2014





# berker R.3

Debido a su marco angulado y la disposición circular de las piezas centrales, berker R.3 destaca por la fuerza del contraste. Al igual que berker R.1, los diferentes modelos abarcan todas las características que se le pueden exigir actualmente a un interruptor.



product  
design award  
2013



reddot design award  
winner 2013





# berker R.8

Berker R.8 rinde homenaje a la máxima "menos es más" - sobresaliendo solo 3 mm de la pared, lo que le convierte en uno de los interruptores más planos del mercado. Como evolución lógica de la gama berker R.3 ésta le proporciona su base perfecta tanto en función como en forma: Se puede combinar con cualquiera de las teclas de esta gama.



## Marcos



1011 21 89

## Marcos blanco polar, brillo

Descripción	Referencia	Emb.	Precio (€)
<b>1 elemento</b>	1011 21 89	10	<b>3,13</b>
<b>2 elementos</b>	1012 21 89	2	<b>5,16</b>
<b>3 elementos</b>	1013 21 89	2	<b>9,13</b>
<b>4 elementos</b>	1014 21 89	2	<b>12,75</b>
<b>5 elementos</b>	1015 21 89	2	<b>20,89</b>

• Montaje vertical y horizontal



1011 21 45

## Marcos negro, brillo

Descripción	Referencia	Emb.	Precio (€)
<b>1 elemento</b>	1011 21 45	10	<b>5,85</b>
<b>2 elementos</b>	1012 21 45	2	<b>8,46</b>
<b>3 elementos</b>	1013 21 45	10	<b>13,61</b>
<b>4 elementos</b>	1014 21 45	2	<b>22,07</b>
<b>5 elementos</b>	1015 21 45	2	<b>30,86</b>

• Montaje vertical y horizontal



1011 21 74

## Marcos aluminio/blanco polar

Descripción	Referencia	Emb.	Precio (€)
<b>1 elemento</b>	1011 21 74	10	<b>51,58</b>
<b>2 elementos</b>	1012 21 74	10	<b>91,05</b>
<b>3 elementos</b>	1013 21 74	10	<b>103,73</b>
<b>4 elementos</b>	1014 21 74	2	<b>141,88</b>
<b>5 elementos</b>	1015 21 74	2	<b>193,38</b>

• Montaje vertical y horizontal



1011 21 84

## Marcos aluminio/negro

Descripción	Referencia	Emb.	Precio (€)
<b>1 elemento</b>	1011 21 84	10	<b>51,58</b>
<b>2 elementos</b>	1012 21 84	10	<b>91,05</b>
<b>3 elementos</b>	1013 21 84	10	<b>99,38</b>
<b>4 elementos</b>	1014 21 84	2	<b>135,95</b>
<b>5 elementos</b>	1015 21 84	2	<b>185,28</b>

• Montaje vertical y horizontal



1011 21 14

## Marcos acero/blanco polar

Descripción	Referencia	Emb.	Precio (€)
<b>1 elemento</b>	1011 21 14	10	<b>58,02</b>
<b>2 elementos</b>	1012 21 14	10	<b>102,43</b>
<b>3 elementos</b>	1013 21 14	10	<b>171,27</b>
<b>4 elementos</b>	1014 21 14	2	<b>234,27</b>
<b>5 elementos</b>	1015 21 14	2	<b>319,30</b>

• Montaje vertical y horizontal



1011 21 04

## Marcos acero/negro

<b>1 elemento</b>	1011 21 04	10	<b>58,02</b>
<b>2 elementos</b>	1012 21 04	10	<b>102,43</b>
<b>3 elementos</b>	1013 21 04	10	<b>171,27</b>
<b>4 elementos</b>	1014 21 04	2	<b>234,27</b>
<b>5 elementos</b>	1015 21 04	2	<b>319,30</b>

• Montaje vertical y horizontal



1011 21 09

## Marcos cristal blanco polar

Descripción	Referencia	Emb.	Precio (€)
<b>1 elemento</b>	1011 21 09	10	<b>38,67</b>
<b>2 elementos</b>	1012 21 09	5	<b>68,30</b>
<b>3 elementos</b>	1013 21 09	5	<b>89,92</b>
<b>4 elementos</b>	1014 21 09	1	<b>122,99</b>
<b>5 elementos</b>	1015 21 09	1	<b>167,62</b>

• Montaje vertical y horizontal



1011 21 16

## Marcos cristal negro

Descripción	Referencia	Emb.	Precio (€)
<b>1 elemento</b>	1011 21 16	10	<b>38,67</b>
<b>2 elementos</b>	1012 21 16	5	<b>68,30</b>
<b>3 elementos</b>	1013 21 16	5	<b>88,75</b>
<b>4 elementos</b>	1014 21 16	1	<b>121,40</b>
<b>5 elementos</b>	1015 21 16	1	<b>165,43</b>

• Montaje vertical y horizontal



1011 23 89

## Marcos pizarra, blanco polar

Descripción	Referencia	Emb.	Precio (€)
<b>1 elemento</b>	1011 23 89	1	<b>59,02</b>
<b>2 elementos</b>	1012 23 89	1	<b>94,24</b>
<b>3 elementos</b>	1013 23 89	1	<b>136,64</b>

• Montaje vertical y horizontal



1011 23 84

## Marcos pizarra, negro

Descripción	Referencia	Emb.	Precio (€)
<b>1 elemento</b>	1011 23 84	1	<b>57,93</b>
<b>2 elementos</b>	1012 23 84	1	<b>94,84</b>
<b>3 elementos</b>	1013 23 84	1	<b>136,64</b>

• Montaje vertical y horizontal



1011 23 79

## Marcos hormigón, blanco polar

Descripción	Referencia	Emb.	Precio (€)
<b>1 elemento</b>	1011 23 79	1	<b>70,62</b>
<b>2 elementos</b>	1012 23 79	1	<b>126,97</b>
<b>3 elementos</b>	1013 23 79	1	<b>183,48</b>

• Montaje vertical y horizontal



1011 23 74

## Marcos hormigón, negro

Descripción	Referencia	Emb.	Precio (€)
<b>1 elemento</b>	1011 23 74	1	<b>70,62</b>
<b>2 elementos</b>	1012 23 74	1	<b>126,97</b>
<b>3 elementos</b>	1013 23 74	1	<b>183,48</b>

• Montaje vertical y horizontal



1011 23 69

## Marcos piel marrón, blanco polar

Descripción	Referencia	Emb.	Precio (€)
<b>1 elemento</b>	1011 23 69	1	<b>35,36</b>
<b>2 elementos</b>	1012 23 69	1	<b>62,46</b>
<b>3 elementos</b>	1013 23 69	1	<b>104,41</b>
<b>4 elementos</b>	1014 23 69	1	<b>142,80</b>
<b>5 elementos</b>	1015 23 69	1	<b>194,64</b>

• Montaje vertical y horizontal



1011 23 64

## Marcos piel marrón, negro

Descripción	Referencia	Emb.	Precio (€)
<b>1 elemento</b>	1011 23 64	1	<b>35,36</b>
<b>2 elementos</b>	1012 23 64	1	<b>62,46</b>
<b>3 elementos</b>	1013 23 64	1	<b>104,41</b>
<b>4 elementos</b>	1014 23 64	1	<b>142,80</b>
<b>5 elementos</b>	1015 23 64	1	<b>194,64</b>

• Montaje vertical y horizontal



1011 23 59

## Marcos madera, blanco polar

Descripción	Referencia	Emb.	Precio (€)
<b>1 elemento</b>	1011 23 59	1	<b>35,36</b>
<b>2 elementos</b>	1012 23 59	1	<b>62,46</b>
<b>3 elementos</b>	1013 23 59	1	<b>104,41</b>
<b>4 elementos</b>	1014 23 59	1	<b>142,80</b>
<b>5 elementos</b>	1015 23 59	1	<b>194,64</b>

• Montaje vertical y horizontal



1011 23 54

## Marcos madera, negro

Descripción	Referencia	Emb.	Precio (€)
<b>1 elemento</b>	1011 23 54	1	<b>35,36</b>
<b>2 elementos</b>	1012 23 54	1	<b>62,46</b>
<b>3 elementos</b>	1013 23 54	1	<b>104,41</b>
<b>4 elementos</b>	1014 23 54	1	<b>142,80</b>
<b>5 elementos</b>	1015 23 54	1	<b>194,64</b>

• Montaje vertical y horizontal



1011 23 49

**Marcos acrílico rojo, blanco polar**

Descripción	Referencia	Emb.	Precio (€)
<b>1 elemento</b>	1011 23 49	1	<b>35,36</b>
<b>2 elementos</b>	1012 23 49	1	<b>62,46</b>
<b>3 elementos</b>	1013 23 49	1	<b>104,41</b>
<b>4 elementos</b>	1014 23 49	1	<b>142,80</b>
<b>5 elementos</b>	1015 23 49	1	<b>194,64</b>

- Montaje vertical y horizontal



1011 23 44

**Marcos acrílico rojo, negro**

Descripción	Referencia	Emb.	Precio (€)
<b>1 elemento</b>	1011 23 44	1	<b>35,36</b>
<b>2 elementos</b>	1012 23 44	1	<b>62,46</b>
<b>3 elementos</b>	1013 23 44	1	<b>104,41</b>
<b>4 elementos</b>	1014 23 44	1	<b>142,80</b>
<b>5 elementos</b>	1015 23 44	1	<b>194,64</b>

- Montaje vertical y horizontal



1011 23 39

**Marcos acrílico naranja, blanco polar**

Descripción	Referencia	Emb.	Precio (€)
<b>1 elemento</b>	1011 23 39	1	<b>35,36</b>
<b>2 elementos</b>	1012 23 39	1	<b>62,46</b>
<b>3 elementos</b>	1013 23 39	1	<b>104,41</b>
<b>4 elementos</b>	1014 23 39	1	<b>142,80</b>
<b>5 elementos</b>	1015 23 39	1	<b>194,64</b>

- Montaje vertical y horizontal



1011 23 34

**Marcos acrílico naranja, negro**

Descripción	Referencia	Emb.	Precio (€)
<b>1 elemento</b>	1011 23 34	1	<b>35,36</b>
<b>2 elementos</b>	1012 23 34	1	<b>62,46</b>
<b>3 elementos</b>	1013 23 34	1	<b>104,41</b>
<b>4 elementos</b>	1014 23 34	1	<b>142,80</b>
<b>5 elementos</b>	1015 23 34	1	<b>194,64</b>

- Montaje vertical y horizontal



1011 21 79

**Marco con portaetiquetas, blanco polar, brillo**

Descripción	Referencia	Emb.	Precio (€)
<b>1 elemento</b>	1011 21 79	10	<b>8,42</b>
<b>2 elementos, vertical</b>	1012 21 69	2	<b>12,23</b>
<b>2 elementos, horizontal</b>	1012 21 79	2	<b>12,60</b>
<b>3 elementos, vertical</b>	1013 21 69	2	<b>13,72</b>
<b>3 elementos, horizontal</b>	1013 21 79	2	<b>13,72</b>

- Etiquetas de 6 mm. alto



1011 21 35

**Marco con portaetiquetas, negro, brillo**

Descripción	Referencia	Emb.	Precio (€)
<b>1 elemento</b>	1011 21 35	10	<b>9,58</b>
<b>2 elementos, vertical</b>	1012 21 25	2	<b>13,79</b>
<b>2 elementos, horizontal</b>	1012 21 35	2	<b>13,79</b>
<b>3 elementos, vertical</b>	1013 21 25	2	<b>22,22</b>
<b>3 elementos, horizontal</b>	1013 21 35	2	<b>22,22</b>

- Etiquetas de 6 mm. alto

**Nota:** En instalaciones en paredes de tabique hueco, se recomienda dejar la caja de empotrar enrasada con la pared con el fin de que la instalación de nuestras series de mecanismos se realice de la manera que se han diseñado. Recomendamos el uso de una sierra de corona con avellanador.

**Nota:** La madera, piel, pizarra y hormigón son un material natural. Las desviaciones en color y estructura son parte de sus propiedades y no representan ningún defecto sino, que hablan de la calidad individual del material y de los productos.

Series berker

## Marcos



1011 22 89

## Marcos blanco polar, brillo

Descripción	Referencia	Emb.	Precio (€)
<b>1 elemento</b>	1011 22 89	10	<b>3,13</b>
<b>2 elementos</b>	1012 22 89	2	<b>5,16</b>
<b>3 elementos</b>	1013 22 89	2	<b>9,13</b>
<b>4 elementos</b>	1014 22 89	2	<b>12,75</b>
<b>5 elementos</b>	1015 22 89	2	<b>20,89</b>

- Montaje vertical y horizontal



1011 22 45

## Marcos negro, brillo

Descripción	Referencia	Emb.	Precio (€)
<b>1 elemento</b>	1011 22 45	10	<b>5,85</b>
<b>2 elementos</b>	1012 22 45	2	<b>8,46</b>
<b>3 elementos</b>	1013 22 45	10	<b>13,61</b>
<b>4 elementos</b>	1014 22 45	2	<b>22,07</b>
<b>5 elementos</b>	1015 22 45	2	<b>30,86</b>

- Montaje vertical y horizontal



1011 22 74

## Marcos aluminio/blanco polar

Descripción	Referencia	Emb.	Precio (€)
<b>1 elemento</b>	1011 22 74	10	<b>51,58</b>
<b>2 elementos</b>	1012 22 74	10	<b>91,05</b>
<b>3 elementos</b>	1013 22 74	10	<b>103,73</b>
<b>4 elementos</b>	1014 22 74	2	<b>141,88</b>
<b>5 elementos</b>	1015 22 74	2	<b>193,38</b>

- Montaje vertical y horizontal

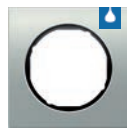

1011 22 84

## Marcos aluminio/negro

Descripción	Referencia	Emb.	Precio (€)
<b>1 elemento</b>	1011 22 84	10	<b>51,58</b>
<b>2 elementos</b>	1012 22 84	10	<b>91,05</b>
<b>3 elementos</b>	1013 22 84	10	<b>99,38</b>
<b>4 elementos</b>	1014 22 84	2	<b>135,95</b>
<b>5 elementos</b>	1015 22 84	2	<b>185,28</b>

- Montaje vertical y horizontal



1011 22 14

## Marcos acero/blanco polar

Descripción	Referencia	Emb.	Precio (€)
<b>1 elemento</b>	1011 22 14	10	<b>58,02</b>
<b>2 elementos</b>	1012 22 14	10	<b>102,43</b>
<b>3 elementos</b>	1013 22 14	10	<b>171,27</b>
<b>4 elementos</b>	1014 22 14	2	<b>234,27</b>
<b>5 elementos</b>	1015 22 14	2	<b>319,30</b>

- Montaje vertical y horizontal

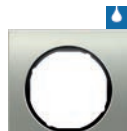

1011 22 04

## Marcos acero/negro

Descripción	Referencia	Emb.	Precio (€)
<b>1 elemento</b>	1011 22 04	10	<b>58,02</b>
<b>2 elementos</b>	1012 22 04	10	<b>102,43</b>
<b>3 elementos</b>	1013 22 04	10	<b>171,27</b>
<b>4 elementos</b>	1014 22 04	2	<b>234,27</b>
<b>5 elementos</b>	1015 22 04	2	<b>319,30</b>

- Montaje vertical y horizontal



1011 22 09

## Marcos cristal blanco polar

Descripción	Referencia	Emb.	Precio (€)
<b>1 elemento</b>	1011 22 09	10	<b>38,67</b>
<b>2 elementos</b>	1012 22 09	5	<b>68,30</b>
<b>3 elementos</b>	1013 22 09	5	<b>89,92</b>
<b>4 elementos</b>	1014 22 09	1	<b>122,99</b>
<b>5 elementos</b>	1015 22 09	1	<b>167,62</b>

- Montaje vertical y horizontal



1011 22 16

## Marcos cristal negro

Descripción	Referencia	Emb.	Precio (€)
<b>1 elemento</b>	1011 22 16	10	<b>38,67</b>
<b>2 elementos</b>	1012 22 16	5	<b>68,30</b>
<b>3 elementos</b>	1013 22 16	5	<b>88,75</b>
<b>4 elementos</b>	1014 22 16	1	<b>121,40</b>
<b>5 elementos</b>	1015 22 16	1	<b>165,43</b>

- Montaje vertical y horizontal



1011 22 79

## Marco con portaetiquetas, blanco polar, brillo

Descripción	Referencia	Emb.	Precio (€)
<b>1 elemento</b>	1011 22 79	10	<b>8,42</b>
<b>2 elementos, vertical</b>	1012 22 69	2	<b>12,60</b>
<b>2 elementos, horizontal</b>	1012 22 79	2	<b>12,60</b>
<b>3 elementos, vertical</b>	1013 22 69	2	<b>13,72</b>
<b>3 elementos, horizontal</b>	1013 22 79	2	<b>13,72</b>

- Etiquetas de 6 mm. alto



1011 22 35

## Marco con portaetiquetas, negro, brillo

Descripción	Referencia	Emb.	Precio (€)
<b>1 elemento</b>	1011 22 35	10	<b>9,58</b>
<b>2 elementos, vertical</b>	1012 22 25	2	<b>13,79</b>
<b>2 elementos, horizontal</b>	1012 22 35	2	<b>13,79</b>
<b>3 elementos, vertical</b>	1013 22 25	2	<b>22,22</b>
<b>3 elementos, horizontal</b>	1013 22 35	2	<b>22,22</b>

- Etiquetas de 6 mm. alto

## Cajas para montaje en superficie berker R.3



1041 89 89

## Caja montaje en superficie, 1 elemento

Descripción	Referencia	Emb.	Precio (€)
<b>Blanco polar, brillo</b>	1041 89 89	10	<b>14,25</b>
<b>Negro, brillo</b>	1041 89 35	10	<b>13,01</b>



1042 89 89

## Caja montaje en superficie, 2 elementos

Descripción	Referencia	Emb.	Precio (€)
<b>Blanco polar, brillo</b>	1042 89 89	5	<b>25,17</b>
<b>Negro, brillo</b>	1042 89 35	5	<b>22,32</b>



1043 89 89

## Caja montaje en superficie, 3 elementos

Descripción	Referencia	Emb.	Precio (€)
<b>Blanco polar, brillo</b>	1043 89 89	5	<b>39,69</b>
<b>Negro, brillo</b>	1043 89 35	5	<b>34,95</b>

**Nota:** En instalaciones en paredes de tabique hueco, se recomienda dejar la caja de empotrar enrasada con la pared con el fin de que la instalación de nuestras series de mecanismos se realice de la manera que se han diseñado. Recomendamos el uso de una sierra de corona con avellanador.

## Marcos

### Marcos cristal blanco polar



1011 26 09

Descripción	Referencia	Emb.	Precio (€)
<b>1 elemento</b>	1011 26 09	1	<b>38,44</b>
<b>2 elementos</b>	1012 26 09	1	<b>67,84</b>
<b>3 elementos</b>	1013 26 09	1	<b>89,35</b>
<b>4 elementos</b>	1014 26 09	1	<b>122,19</b>

- Montaje vertical y horizontal

### Marcos cristal negro

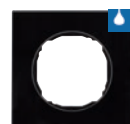

1011 26 16

Descripción	Referencia	Emb.	Precio (€)
<b>1 elemento</b>	1011 26 16	1	<b>38,44</b>
<b>2 elementos</b>	1012 26 16	1	<b>67,84</b>
<b>3 elementos</b>	1013 26 16	1	<b>89,35</b>
<b>4 elementos</b>	1014 26 16	1	<b>122,19</b>

- Montaje vertical y horizontal

### Marcos aluminio



1011 26 74

Descripción	Referencia	Emb.	Precio (€)
<b>1 elemento</b>	1011 26 74	1	<b>57,62</b>
<b>2 elementos</b>	1012 26 74	1	<b>101,78</b>
<b>3 elementos</b>	1013 26 74	1	<b>170,15</b>
<b>4 elementos</b>	1014 26 74	1	<b>232,77</b>

- Montaje vertical y horizontal

### Marcos acero



1011 26 14

Descripción	Referencia	Emb.	Precio (€)
<b>1 elemento</b>	1011 26 14	1	<b>57,62</b>
<b>2 elementos</b>	1012 26 14	1	<b>101,78</b>
<b>3 elementos</b>	1013 26 14	1	<b>170,15</b>
<b>4 elementos</b>	1014 26 14	1	<b>232,77</b>

- Montaje vertical y horizontal

## Cajas de empotrar berker R.8



1872 00 10

### Caja de empotrar roja

Descripción	Referencia	Emb.	Precio (€)
<b>1 elemento</b>	1872 00 10	1	<b>2,60</b>
<b>2 elementos</b>	1872 00 20	1	<b>3,86</b>
<b>3 elementos</b>	1872 00 30	1	<b>5,12</b>
<b>4 elementos</b>	1872 00 40	1	<b>6,43</b>

- 54 mm



1872 10 10

### Caja de empotrar blanca

Descripción	Referencia	Emb.	Precio (€)
<b>1 elemento</b>	1872 10 10	1	<b>2,60</b>
<b>2 elementos</b>	1872 10 20	1	<b>3,86</b>
<b>3 elementos</b>	1872 10 30	1	<b>5,12</b>
<b>4 elementos</b>	1872 10 40	1	<b>6,43</b>

- 59 mm

Instalaciones en muro: caja de empotrar roja + blanca  
Instalaciones en yeso: caja de empotrar blanca

Ver videos de instalación en nuestro canal de youtube: HagerSpain

**Nota:** En instalaciones en paredes de tabique hueco, se recomienda dejar la caja de empotrar enrasada con la pared con el fin de que la instalación de nuestras series de mecanismos se realice de la manera que se han diseñado. Recomendamos el uso de una sierra de corona con avellanador.

## Tomas SCHUKO



1719 20 89

### Tapa para SCHUKO

Descripción	Referencia	Emb.	Precio (€)
<b>Blanco polar, brillo</b>	1719 20 89	10	<b>5,12</b>
<b>Negro, brillo</b>	1719 20 45	10	<b>5,60</b>
<b>Rojo</b>	1719 20 22	10	<b>5,12</b>

- Añadir mecanismo ref. 714134
- Con protección infantil



1720 20 89

### Tapa para SCHUKO con tapa articulada

Descripción	Referencia	Emb.	Precio (€)
<b>Blanco polar, brillo</b>	1720 20 89	10	<b>20,65</b>
<b>Negro, brillo</b>	1720 20 45	10	<b>23,44</b>

- Añadir mecanismo ref. 714134



73 4123 20 89

### Toma SCHUKO completa

Descripción	Referencia	Emb.	Precio (€)
<b>Blanco polar, brillo</b>	73 4123 20 89	1	<b>10,28</b>



4109 20 89

### Toma SCHUKO con LED de orientación

Descripción	Referencia	Emb.	Precio (€)
<b>Blanco polar, brillo</b>	4109 20 89	10	<b>110,27</b>
<b>Negro, brillo</b>	4109 20 45	10	<b>110,27</b>

- 16A, 250 V ~
- Con protección infantil
- Terminales tornillo con mordaza



4110 20 89

### Toma SCHUKO con LED de control

Descripción	Referencia	Emb.	Precio (€)
<b>Blanco polar, brillo</b>	4110 20 89	10	<b>97,65</b>
<b>Negro, brillo</b>	4110 20 45	10	<b>97,65</b>

- 16A, 250 V ~
- Con protección infantil
- Terminales tornillo con mordaza

## Kits de sellado IP44



1010 76 00

### Kit para tomas schuko y tapas

Descripción	Referencia	Emb.	Precio (€)
<b>Transparente</b>	1010 76 00	1	<b>8,30</b>



1010 77 00

### Kit para tecla interruptor y pulsador

Descripción	Referencia	Emb.	Precio (€)
<b>Transparente</b>	1010 77 00	1	<b>13,08</b>



1010 78 00

### Kit para mecanismos persianas

Descripción	Referencia	Emb.	Precio (€)
<b>Transparente</b>	1010 78 00	1	<b>12,89</b>

## Teclas



1620 20 89

### Teclas

Descripción	Referencia	Emb.	Precio (€)
<b>Blanco polar, brillo</b>	1620 20 89	10	<b>2,99</b>
<b>Negro, brillo</b>	1620 20 45	10	<b>6,41</b>



1620 20 79

### Teclas con símbolo luz

Descripción	Referencia	Emb.	Precio (€)
<b>Blanco polar, brillo</b>	1620 20 79	10	<b>3,51</b>
<b>Negro, brillo</b>	1620 20 35	10	<b>7,50</b>



1620 20 69

### Teclas con símbolo campana

Descripción	Referencia	Emb.	Precio (€)
<b>Blanco polar, brillo</b>	1620 20 69	10	<b>3,51</b>
<b>Negro, brillo</b>	1620 20 25	10	<b>7,50</b>



1620 20 59

### Teclas con símbolo llave

Descripción	Referencia	Emb.	Precio (€)
<b>Blanco polar, brillo</b>	1620 20 59	10	<b>3,51</b>
<b>Negro, brillo</b>	1620 20 15	10	<b>7,50</b>



1621 20 89

### Teclas con indicador luminoso

Descripción	Referencia	Emb.	Precio (€)
<b>Blanco polar, brillo</b>	1621 20 89	10	<b>4,84</b>
<b>Negro, brillo</b>	1621 20 45	10	<b>7,50</b>



1621 20 79

### Teclas con indicador luminoso y símbolo luz

Descripción	Referencia	Emb.	Precio (€)
<b>Blanco polar, brillo</b>	1621 20 79	10	<b>6,72</b>
<b>Negro, brillo</b>	1621 20 35	10	<b>7,50</b>



1622 20 89

### Teclas con símbolo "0"

Descripción	Referencia	Emb.	Precio (€)
<b>Blanco polar, brillo</b>	1622 20 89	10	<b>5,24</b>
<b>Negro, brillo</b>	1622 20 45	10	<b>7,50</b>



1624 20 89

### Teclas con símbolo "0" e indicador luminoso

Descripción	Referencia	Emb.	Precio (€)
<b>Blanco polar, brillo</b>	1624 20 89	10	<b>6,72</b>
<b>Negro, brillo</b>	1624 20 45	10	<b>7,50</b>



1623 20 89

### Teclas dobles

Descripción	Referencia	Emb.	Precio (€)
<b>Blanco polar, brillo</b>	1623 20 89	10	<b>4,23</b>
<b>Negro, brillo</b>	1623 20 45	10	<b>9,12</b>



**Teclas dobles con indicador luminoso**

Descripción	Referencia	Emb.	Precio (€)
<b>Blanco polar, brillo</b>	1627 20 89	10	<b>9,05</b>
<b>Negro, brillo</b>	1627 20 45	10	<b>11,29</b>

1627 20 89



**Tecla doble persiana**

Descripción	Referencia	Emb.	Precio (€)
<b>Blanco polar, brillo</b>	1625 20 89	10	<b>5,25</b>
<b>Negro, brillo</b>	1625 20 45	10	<b>11,29</b>

1625 20 89



**Tecla triple persiana**

Descripción	Referencia	Emb.	Precio (€)
<b>Blanco polar, brillo</b>	1665 20 89	10	<b>19,95</b>
<b>Negro, brillo</b>	1665 20 45	10	<b>20,72</b>

1665 20 89

**Teclas sin barreras**



**Tecla simple con indicador luminoso**

Descripción	Referencia	Emb.	Precio (€)
<b>Blanco polar, brillo</b>	1661 20 49	10	<b>38,59</b>

1661 20 49



**Tecla simple con indicador luminoso y símbolo luz en relieve**

Descripción	Referencia	Emb.	Precio (€)
<b>Blanco polar, brillo</b>	1651 20 49	10	<b>29,57</b>

1651 20 49



**Tecla simple con indicador luminoso y símbolo campana en relieve**

Descripción	Referencia	Emb.	Precio (€)
<b>Blanco polar, brillo</b>	1651 20 89	10	<b>29,52</b>

1651 20 89



**Tecla simple con indicador luminoso y símbolo llave en relieve**

Descripción	Referencia	Emb.	Precio (€)
<b>Blanco polar, brillo</b>	1651 20 69	10	<b>29,52</b>

1651 20 69

**Tapas**



**Tapa interruptor/pulsador tirador**

Descripción	Referencia	Emb.	Precio (€)
<b>Blanco polar, brillo</b>	1146 20 89	10	<b>7,10</b>
<b>Negro, brillo</b>	1146 20 45	10	<b>7,73</b>

1146 20 89



**Tapa p/interruptor 3 posiciones con mando rotativo**

Descripción	Referencia	Emb.	Precio (€)
<b>Blanco polar, brillo</b>	1084 20 89 00	1	<b>24,13</b>
<b>Negro, brillo</b>	1084 20 45 00	1	<b>24,63</b>

1084 20 89



**Tapa p/interruptor 3 posiciones y 0 con mando rotativo**

Descripción	Referencia	Emb.	Precio (€)
<b>Blanco polar, brillo</b>	1096 20 89 00	1	<b>24,22</b>
<b>Negro, brillo</b>	1096 20 45 00	1	<b>24,69</b>

1096 20 89



**Tapa p/interruptor/pulsador rotativo para persianas**

Descripción	Referencia	Emb.	Precio (€)
<b>Blanco polar, brillo</b>	1080 20 89 00	1	<b>24,22</b>
<b>Negro, brillo</b>	1080 20 45 00	1	<b>24,69</b>

1080 20 89



**Tapa para interruptor llave persianas**

Descripción	Referencia	Emb.	Precio (€)
<b>Blanco polar</b>	1506 20 89	10	<b>19,09</b>
<b>Negro</b>	1506 20 45	10	<b>19,09</b>

1506 20 89

• con símbolo



Descripción	Referencia	Emb.	Precio (€)
<b>Blanco polar</b>	1507 20 89	10	<b>8,72</b>
<b>Negro</b>	1507 20 45	10	<b>8,72</b>

1507 20 89

• sin símbolo

**Tapa toma USB de carga**



**Tapa cargador USB**

Descripción	Referencia	Emb.	Precio (€)
<b>Blanco polar, brillo</b>	68 1033 20 89	10	<b>5,48</b>
<b>Negro brillo</b>	68 1033 20 45	10	<b>8,83</b>

68 1033 20 89

**Tapas ciegas**



**Tapa ciega con tapa central**

Descripción	Referencia	Emb.	Precio (€)
<b>Blanco polar, brillo</b>	1009 20 89	20	<b>10,62</b>
<b>Negro, brillo</b>	1009 20 45	20	<b>11,31</b>

1009 20 89

**Lámparas piloto**



**Tapa central para pulsador y lámpara E10**

Descripción	Referencia	Emb.	Precio (€)
<b>Blanco polar, brillo</b>	1124 20 89	10	<b>5,69</b>
<b>Negro, brillo</b>	1124 20 45	10	<b>6,25</b>

1124 20 89



**Tapa central para lámpara E14**

Descripción	Referencia	Emb.	Precio (€)
<b>Blanco polar, brillo</b>	1198 20 89	10	<b>6,48</b>
<b>Negro, brillo</b>	1198 20 45	10	<b>6,65</b>

1198 20 89

**Temporizadores**



**Tapa c/mando rotativo para temporizador mecánico**

Descripción	Referencia	Emb.	Precio (€)
<b>Máximo 15 minutos</b>			
<b>Blanco polar, brillo</b>	1632 20 89	1	<b>23,53</b>
<b>Negro, brillo</b>	1632 20 45	1	<b>24,10</b>

1632 20 89

**Máximo 120 minutos**

<b>Blanco polar, brillo</b>	1633 20 89	1	<b>23,53</b>
<b>Negro, brillo</b>	1633 20 45	1	<b>24,10</b>

## Regulador rotativo



1137 20 89

## Mando rotativo para regulador rotativo

Descripción	Referencia	Emb.	Precio (€)
<b>Blanco polar, brillo</b>	1137 20 89	10	<b>14,52</b>
<b>Negro, brillo</b>	1137 20 45	10	<b>14,63</b>

## Control velocidad



1137 20 79

## Tapa central con mando para control velocidad

Descripción	Referencia	Emb.	Precio (€)
<b>Blanco polar, brillo</b>	1137 20 79	10	<b>22,51</b>
<b>Negro, brillo</b>	1137 20 35	10	<b>23,07</b>

## Tarjetero hotel electrónico



1640 20 89

## Tarjetero hotel electrónico

Descripción	Referencia	Emb.	Precio (€)
<b>Blanco polar, brillo</b>	1640 20 89	1	<b>85,39</b>
<b>Negro, brillo</b>	1640 20 45	1	<b>85,65</b>

## Termostatos



2034 20 89

## Termostato con contacto NA, para suelo radiante

Descripción	Referencia	Emb.	Precio (€)
<b>Blanco polar, brillo</b>	2034 20 89	1	<b>194,80</b>
<b>Negro, brillo</b>	2034 20 45	1	<b>197,73</b>



2026 20 89

## Termostato con conmutador

Descripción	Referencia	Emb.	Precio (€)
<b>Blanco polar, brillo</b>	2026 20 89	1	<b>96,69</b>
<b>Negro, brillo</b>	2026 20 45	1	<b>99,60</b>



2030 20 89

## Termostato con contacto NC

Descripción	Referencia	Emb.	Precio (€)
<b>Blanco polar, brillo</b>	2030 20 89	1	<b>95,27</b>
<b>Negro, brillo</b>	2030 20 45	1	<b>98,18</b>

## TV / Audio / Video



33 1540 20 89

## Toma VGA

Descripción	Referencia	Emb.	Precio (€)
<b>Blanco polar, brillo</b>	33 1540 20 89	10	<b>73,21</b>
<b>Negro, brillo</b>	33 1540 20 45	10	<b>85,40</b>



33 1541 20 89

## Toma VGA con terminales a tornillo y mordaza

Descripción	Referencia	Emb.	Precio (€)
<b>Blanco polar, brillo</b>	33 1541 20 89	10	<b>81,04</b>
<b>Negro, brillo</b>	33 1541 20 45	10	<b>79,73</b>



33 1532 20 89

## Toma 3 x Cinch/S-Video

Descripción	Referencia	Emb.	Precio (€)
<b>Blanco polar, brillo</b>	33 1532 20 89	10	<b>106,07</b>
<b>Negro, brillo</b>	33 1532 20 45	10	<b>106,80</b>



33 1542 20 89

## Toma alta definición

Descripción	Referencia	Emb.	Precio (€)
<b>Blanco polar, brillo</b>	33 1542 20 89	10	<b>121,00</b>
<b>Negro, brillo</b>	33 1542 20 45	10	<b>121,73</b>



33 1543 20 89

## Toma alta definición con conexión 90°

Descripción	Referencia	Emb.	Precio (€)
<b>Blanco polar, brillo</b>	33 1543 20 89	10	<b>121,00</b>
<b>Negro, brillo</b>	33 1543 20 45	10	<b>121,73</b>



33 1539 20 89

## Toma USB / audio 3,5 mm

Descripción	Referencia	Emb.	Precio (€)
<b>Blanco polar, brillo</b>	33 1539 20 89	10	<b>70,21</b>



1432 20 89

## Tapa central para conectores 22,5 mm

Descripción	Referencia	Emb.	Precio (€)
<b>Blanco polar, brillo</b>	1432 20 89	10	<b>8,35</b>
<b>Negro, brillo</b>	1432 20 45	10	<b>11,86</b>



1196 20 89

## Tapa central para toma altavoz y conector mini

Descripción	Referencia	Emb.	Precio (€)
<b>Blanco polar, brillo</b>	1196 20 89	10	<b>6,83</b>
<b>Negro, brillo</b>	1196 20 45	10	<b>7,38</b>



1203 20 89

## Tapa central para toma TV 2 ó 3 salidas

Descripción	Referencia	Emb.	Precio (€)
<b>Blanco polar, brillo</b>	1203 20 89	10	<b>6,71</b>
<b>Negro, brillo</b>	1203 20 45	10	<b>7,25</b>



1484 20 89

## Tapa central para toma TV 4 salidas

Descripción	Referencia	Emb.	Precio (€)
<b>Blanco polar, brillo</b>	1484 20 89	10	<b>6,71</b>
<b>Negro, brillo</b>	1484 20 45	10	<b>7,25</b>

## Tapa salida de cables



### Tapa salida de cables

Descripción	Referencia	Emb.	Precio (€)
<b>Blanco polar, brillo</b>	1019 20 89	10	<b>6,71</b>
<b>Negro, brillo</b>	1019 20 45	10	<b>7,25</b>

## Tapas altavoz / datos / telecomunicaciones



### Tapa central para toma TAE y altavoz

Descripción	Referencia	Emb.	Precio (€)
<b>Blanco polar, brillo</b>	1038 20 89	10	<b>6,71</b>
<b>Negro, brillo</b>	1038 20 45	10	<b>7,25</b>

1038 20 89



### Tapa central para toma teléfono / red

Descripción	Referencia	Emb.	Precio (€)
<b>Blanco polar, brillo</b>	1407 20 89	10	<b>6,71</b>
<b>Negro, brillo</b>	1407 20 45	10	<b>7,25</b>

1407 20 89



### Tapa central para toma teléfono / red doble

Descripción	Referencia	Emb.	Precio (€)
<b>Blanco polar, brillo</b>	1409 20 89	10	<b>6,71</b>
<b>Negro, brillo</b>	1409 20 45	10	<b>7,25</b>

1409 20 89



### Tapa central con protección de suciedad y portaetiquetas

Descripción	Referencia	Emb.	Precio (€)
<b>Blanco polar, brillo</b>	1170 20 89	10	<b>15,34</b>
<b>Negro, brillo</b>	1170 20 45	10	<b>15,71</b>

1170 20 89



### Tapa central con protección de suciedad y portaetiquetas doble

Descripción	Referencia	Emb.	Precio (€)
<b>Blanco polar, brillo</b>	1181 20 89	10	<b>18,85</b>
<b>Negro, brillo</b>	1181 20 45	10	<b>19,33</b>



## Mecanismo rotativo con iluminación. El primero.

2019 fue un “año de cambio”. Berker y la legendaria escuela de arte, diseño y arquitectura “Bauhaus” celebraron su 100 aniversario. Para el doble aniversario, hemos relanzado el mecanismo rotativo: un clásico de diseño absoluto. Con un interior completamente renovado y un punto a destacar muy especial: la primera iluminación integrada para interruptores giratorios. Para ver con una nueva luz nuestras series “iluminadas” 1930, Glas y R.classic.



### Alianza entre lo clásico moderno y la alta tecnología.

Los nuevos interruptores rotativos iluminados son tan adecuados para residencial de lujo como para hoteles de diseño y edificios históricos. El legendario edificio Bauhaus de Walter Gropius en Dessau, por ejemplo, está equipado con interruptores de la Serie 1930 (no iluminado).

### Un auténtico logro: El nuevo módulo LED

El nuevo módulo de iluminación se puede usar opcionalmente en los mecanismos rotativos convencionales. Las guías de luz especialmente desarrolladas crean una sutil silueta de luz alrededor del botón giratorio, actuando como orientación y/ o luz de estado. El módulo simplemente está bloqueado en su lugar y se le suministra energía de forma segura a través de resortes de presión. Se puede adaptar en cualquier momento y reemplazar desde la parte frontal.

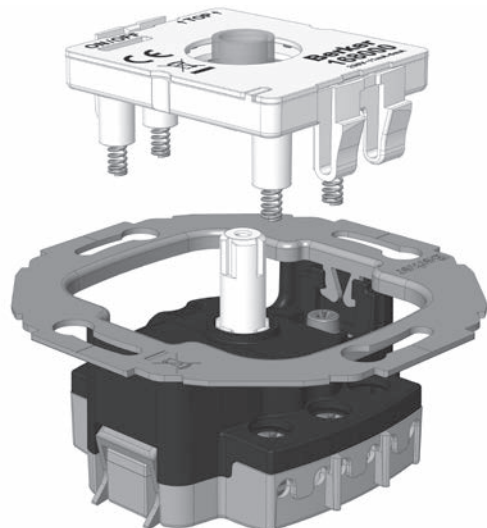

## Mecanismo rotativo con iluminación

# Tres series, una tecnología

Además del módulo de iluminación LED, los mecanismos de nuestras series de diseño clásicas también han evolucionado.

Para el instalador significa: una instalación más fácil con un mayor grado de seguridad si cabe. Para los arquitectos de interiores y clientes finales, que valoran lo excepcional, dejarse convencer por el mejor tacto y una iluminación única.

### Una sujeción excelente

Para simplificar el manejo, hemos transferido las ventajas de instalación probadas de la toma Berker a los nuevos interruptores rotativos. Esto significa: no más bordes afilados. En su lugar: una sensación óptima para una instalación segura. Las garras desaparecen por completo. El mecanismo puede sostenerse de forma segura en la mano y se puede instalar fácilmente.

Los tornillos Pozidriv de fácil acceso proporcionan un agarre perfecto y una transferencia de potencia ideal, mientras que los diagramas de cableado (que pueden leerse de forma clara en el reverso) facilitan la conexión.

### Perfecto en la pared

Ejes reforzados para fijar los mandos rotativos. Esto asegura una conmutación más precisa con una acústica de conmutación excelente y que garantiza una posición exacta del mando rotativo tanto horizontal como verticalmente. Los anillos de centrado aseguran que las placas del bastidor no estén sueltas en el eje de rotación.



### Iluminación de orientación blanco frío

La luz de orientación brilla continuamente en blanco frío para ver el interruptor en la oscuridad. Al mismo tiempo, es tan discreto que no se nota durante el día. Un interruptor en el módulo LED permite al instalador apagar la iluminación de orientación si es necesario.



### De un vistazo:

- Primer interruptor rotativo iluminado
- Luz de orientación: blanco frío, Indicador de estado: Blanco cálido
- Característica de conmutación más precisa
- Acústica de conmutación mejorada
- Instalación y cableado optimizados



### Iluminación de estado blanco cálido

La iluminación de estado blanco cálido es algo más brillante y también indica durante el día si una habitación está ocupada, por ejemplo, el baño o el aseo de invitados.



[hager.es](http://hager.es)

### R.classic

Purismo perfecto: El nuevo módulo LED produce un haz de luz intrincado alrededor del mando rotativo. No sólo se da un particular énfasis al plástico, sino también a otros materiales como cristal, aluminio y acero inoxidable.



### Serie Glas

El nuevo módulo LED produce un efecto particularmente agradable en el cristal a través de la guía de luz, ya sea en edificios antiguos o en ambientes de vida modernos. Puedes elegir un marco transparente o con revestimiento blanco polar en la parte trasera.

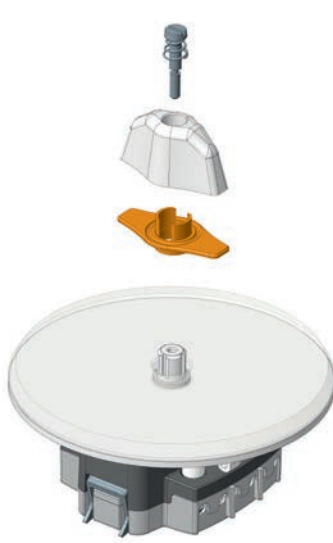

### Serie 1930

Cuando lo retro y la alta tecnología se fusionan: la Serie 1930 está firmemente inspirada en el clásico berker Bauhaus. Con la elección de plástico blanco polar o negro brillante o porcelana "made by Rosenthal".



Cada interruptor rotativo iluminado está diseñado con una guía de luz especial, que también actúa como una pieza central para la tapa.

# Nuevo mecanismo rotativo

## Mayor precisión

El nuevo mecanismo de alta precisión impresiona por su acústica, alta estabilidad y larga vida útil. Sus anillos de apoyo, montaje y manipulación característicos de berker hacen que la instalación sea aún más fácil, rápida y segura.



**01**

### Eje reforzado con anillo de centrado

Para una mayor precisión del interruptor y una acústica excepcional. Gracias al anillo de centrado, la placa envolvente se encuentra en el eje giratorio libre de contragolpe.

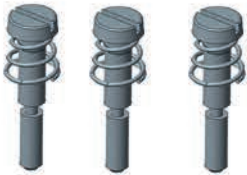

**02**

### Tornillos Pozidriv

Para una transmisión de potencia óptima. Fácil acceso desde la parte frontal.



**03**

### Diagrama de conexiones fácil de leer

Para conectarlo rápidamente sin confusiones.



**04**

### Garras retráctiles de retención

El producto encaja bien en la mano, no tiene bordes afilados y es fácil de instalar.



**05**

### Terminales

Para cable rígido y flexible:  
Para secciones entre 0,75 - 2,5 mm<sup>2</sup>

# Configuración simple en el módulo LED

La luz de orientación puede activarse o desactivarse utilizando un interruptor deslizante en la parte delantera del módulo de iluminación. El puente en la parte trasera se utiliza para activar la visualización de estado. Cuando se enciende la carga, la unidad LED ilumina con un agradable blanco cálido. Para utilizar la luz de estado, se debe conectar un conductor N al interruptor. El interruptor y el jumper significan que hay muchas opciones de configuración diferentes disponibles.

## Opciones de configuración

Mecanismo tipo	Iluminación	Interruptor (orientación)	Jumper J1 (estado B)	Jumper J2 (estado A)
<b>Conmutador rotativo 387603</b>				
Apagado	O	On	-	-
Apagado	O + S	On	■ <sup>1)</sup>	■ <sup>1)</sup>
Apagado	S	Off	■ <sup>1)</sup>	■ <sup>1)</sup>
Apagado múltiple	S	Off	Off	■ <sup>1)</sup>
<b>Interruptor rotativo 387603</b>				
Interruptor	O	On	■ <sup>1)</sup>	■ <sup>1)</sup>
Interruptor	O + S	On	■ <sup>1)</sup>	■ <sup>1)</sup>
Interruptor	S	Off	■ <sup>1)</sup>	■ <sup>1)</sup>
<b>Interruptor doble, OFF 389303</b>				
Interruptor doble, OFF	O	On	Sin función	-
Interruptor doble, OFF	O + S	On	Sin función	■
Interruptor doble, OFF	S	Off	Sin función	■
<b>Pulsador conmutador 384603</b>				
Pulsador conmutador	O	On	-	-

**O Luz de orientación**    **S Luz de estado**



Jumper para la luz de estado



Interruptor para la luz de orientación

1) 1 x jumper conectado, observar los bancos de contactos/contacto de interruptor/ asignación de jumper



# Serie R.classic

Gracias a sus agradables formas redondeadas, las cuatro variantes de material de alta calidad y el interruptor giratorio, los interruptores de la Serie R.classic le harán sentir algo inesperado: entusiasmo.



reddot design award  
winner 2013



Instalación en caja de empotrar redonda.



# Serie 1930

Berker y Bauhaus están unidas por un gusto común por las formas puras y la más directa funcionalidad. Cualidades que siguen apreciando constructores y proyectistas de hoy. Así, la Serie 1930 inspirada en la escuela Bauhaus no sólo se asocia a diseños clásicos sino también a las tendencias más actuales.



Instalación en caja de empotrar redonda.



# Serie 1930

Porzellan made by Rosenthal

La serie Berker 1930, fabricada en verdadera porcelana Rosenthal, constituye un homenaje a la destreza del trabajo manual, la perfección en las formas y la suavidad de materiales.



*Rosenthal*



DESIGN PLUS



Instalación en caja de empotrar redonda.



# Serie Glas

**Sencillez. Belleza real en lugar de belleza aparente. Elegancia creativa como resultado de un objetivo funcional: la serie Glas, inspirada en la arquitectura de la escuela Bauhaus, encontrará la máxima expresión de todas estas características.**



Instalación en caja de empotrar redonda.

## Marcos



1011 20 89

### Marco blanco polar, brillo

Descripción	Referencia	Emb.	Precio (€)
<b>1 elemento</b>	1011 20 89	10	<b>6,71</b>
<b>2 elementos</b>	1012 20 89	2	<b>18,94</b>
<b>3 elementos</b>	1013 20 89	2	<b>28,98</b>



1011 20 45

### Marco negro, brillo

Descripción	Referencia	Emb.	Precio (€)
<b>1 elemento</b>	1011 20 45	10	<b>6,71</b>
<b>2 elementos</b>	1012 20 45	2	<b>18,94</b>
<b>3 elementos</b>	1013 20 45	2	<b>28,98</b>



1011 20 74

### Marco aluminio / blanco polar

Descripción	Referencia	Emb.	Precio (€)
<b>1 elemento</b>	1011 20 74	10	<b>42,99</b>
<b>2 elementos</b>	1012 20 74	10	<b>72,97</b>
<b>3 elementos</b>	1013 20 74	10	<b>105,84</b>



1011 20 84

### Marco aluminio / negro

Descripción	Referencia	Emb.	Precio (€)
<b>1 elemento</b>	1011 20 84	10	<b>42,99</b>
<b>2 elementos</b>	1012 20 84	10	<b>72,97</b>
<b>3 elementos</b>	1013 20 84	10	<b>105,84</b>



1011 20 14

### Marco acero / blanco polar

Descripción	Referencia	Emb.	Precio (€)
<b>1 elemento</b>	1011 20 14	10	<b>55,27</b>
<b>2 elementos</b>	1012 20 14	10	<b>134,51</b>
<b>3 elementos</b>	1013 20 14	10	<b>195,12</b>



1011 20 04

### Marco acero / negro

Descripción	Referencia	Emb.	Precio (€)
<b>1 elemento</b>	1011 20 04	10	<b>55,27</b>
<b>2 elementos</b>	1012 20 04	10	<b>134,51</b>
<b>3 elementos</b>	1013 20 04	10	<b>195,12</b>



1011 20 09

### Marco cristal blanco polar

Descripción	Referencia	Emb.	Precio (€)
<b>1 elemento</b>	1011 20 09	10	<b>36,85</b>
<b>2 elementos</b>	1012 20 09	5	<b>72,97</b>
<b>3 elementos</b>	1013 20 09	5	<b>105,84</b>



1011 20 16

### Marco cristal negro

Descripción	Referencia	Emb.	Precio (€)
<b>1 elemento</b>	1011 20 16	10	<b>36,85</b>
<b>2 elementos</b>	1012 20 16	5	<b>72,97</b>
<b>3 elementos</b>	1013 20 16	5	<b>105,84</b>

**Marcos**



**Marco 1 elemento**

Descripción	Referencia	Emb.	Precio (€)
<b>Blanco polar, brillo</b>	1381 09	10	<b>4,26</b>
<b>Negro, brillo</b>	1381 01	10	<b>4,26</b>

1381 09

- Montaje individual
- Para combinaciones, utilizar el accesorio ref. 1887



**Marco central**

Descripción	Referencia	Emb.	Precio (€)
<b>Blanco polar, brillo</b>	1381 59	10	<b>19,79</b>
<b>Negro, brillo</b>	1381 51	10	<b>19,79</b>

1381 59

- Montaje en combinación



**Marco final**

Descripción	Referencia	Emb.	Precio (€)
<b>Blanco polar, brillo</b>	1381 49	10	<b>16,91</b>
<b>Negro, brillo</b>	1381 41	10	<b>16,91</b>

1381 49

- Montaje en combinación



**Marcos 2 elementos**

Descripción	Referencia	Emb.	Precio (€)
<b>Blanco polar, brillo</b>	1381 29	2	<b>12,02</b>
<b>Negro, brillo</b>	1381 21	2	<b>12,02</b>

1381 29

- Montaje vertical y horizontal



**Marcos 3 elementos**

Descripción	Referencia	Emb.	Precio (€)
<b>Blanco polar, brillo</b>	1381 39	2	<b>18,17</b>
<b>Negro, brillo</b>	1381 31	2	<b>18,17</b>

1381 39

- Montaje vertical y horizontal



**Marco 1 elemento para berker.net**

Descripción	Referencia	Emb.	Precio (€)
<b>Blanco polar, brillo</b>	1382 09	1	<b>6,71</b>
<b>Negro, brillo</b>	1382 01	1	<b>6,71</b>

1382 09

**Caja para montaje en superficie**



1001 09

Descripción	Referencia	Emb.	Precio (€)
<b>Blanco polar, brillo</b>	1001 09	10	<b>29,95</b>
<b>Negro, brillo</b>	1001 01	10	<b>29,95</b>

**Accesorios**



1331 19

**Accesorios para caja de montaje en superficie**

Descripción	Referencia	Emb.	Precio (€)
<b>Blanco polar, brillo</b>	1331 19	10	<b>16,27</b>
<b>Negro, brillo</b>	1331 11	10	<b>16,27</b>



1823 09

**Conectores de combinación**

Descripción	Referencia	Emb.	Precio (€)
<b>Blanco polar, brillo</b>	1823 09	10	<b>3,63</b>
<b>Negro, brillo</b>	1823 05	10	<b>3,63</b>



1813 09

**Entradas de cable y conductos**

Descripción	Referencia	Emb.	Precio (€)
<b>Blanco polar</b>	1813 09	10	<b>2,26</b>
<b>Negro</b>	1813 05	10	<b>2,26</b>
<b>Blanco</b>	1813	10	<b>1,57</b>



1817 09

**Entradas de tubo**

Descripción	Referencia	Emb.	Precio (€)
<b>Blanco polar</b>	1817 09	10	<b>4,38</b>
<b>Negro</b>	1817 05	10	<b>4,38</b>

Series berker

Marcos Serie 1930 Porzellan made by Rosenthal

**Marcos**







**Marco 1 elemento, porcelana**

Descripción	Referencia	Emb.	Precio (€)
<b>Blanco polar, brillo</b>	1381 69	1	<b>47,24</b>
<b>Negro, brillo</b>	1381 65	1	<b>47,24</b>

1381 69

## Marcos

### Marcos cristal transparente

	Descripción	Referencia	Emb.	Precio (€)
 1091	<b>1 elemento, cristal</b>	1091	10	<b>34,46</b>
	<b>1 elemento, cristal, blanco polar</b>	1091 09	10	<b>34,46</b>
 1093	<b>1 elemento intermedio, cristal</b>	1093 00	10	<b>43,98</b>
	<b>1 elem. intermedio, cristal, blanco polar</b>	1093 09	10	<b>43,98</b>
 1092	<b>1 elemento final, cristal</b>	1092 00	10	<b>40,59</b>
	<b>1 elemento final, cristal, blanco polar</b>	1092 19	10	<b>40,59</b>
 1102	<b>2 elementos, cristal</b>	1102	2	<b>62,14</b>
	<b>2 elementos, cristal, blanco polar</b>	1102 09	2	<b>62,14</b>

Ejemplo:

El marco doble para esta composición serían las siguientes referencias: 2 uds. de ref. 1092 00



### Tomas SCHUKO



4755

#### Serie 1930 / Glas

Descripción	Referencia	Emb.	Precio (€)
<b>Blanco polar, brillo</b>	4755	10	<b>32,96</b>
<b>Negro, brillo</b>	4755 01	10	<b>32,96</b>

- Terminales con conexión rápida
- Protección infantil



4755 20 89

#### Serie R.classic

Descripción	Referencia	Emb.	Precio (€)
<b>Blanco polar, brillo</b>	4755 20 89	10	<b>19,78</b>
<b>Negro, brillo</b>	4755 20 45	10	<b>19,78</b>

- Con protección infantil
- Terminales con conexión rápida
- 16A, 250 V~

### Tomas de corriente sistema francés



67 6879

#### Serie 1930 / Glas

Descripción	Referencia	Emb.	Precio (€)
<b>Blanco polar, brillo</b>	67 6879	10	<b>15,91</b>
<b>Negro, brillo</b>	67 6879 01	10	<b>15,91</b>

- Sin protección infantil
- Conexión tornillos



67 6879 20 89

#### Serie R.classic

Descripción	Referencia	Emb.	Precio (€)
<b>Blanco polar, brillo</b>	67 6879 20 89	10	<b>21,27</b>
<b>Negro, brillo</b>	67 6879 20 45	10	<b>21,27</b>

- Sin protección infantil
- Conexión tornillos

### Tomas SCHUKO con led de orientación



4109 20 89

#### Serie R.classic / 1930

Descripción	Referencia	Emb.	Precio (€)
<b>Blanco polar, brillo</b>	4109 20 89	10	<b>110,27</b>
<b>Negro, brillo</b>	4109 20 45	10	<b>110,27</b>

- Con protección infantil
- Terminales tornillo con mordaza

## Mecanismos rotativos y módulo LED para iluminación

### Mecanismos rotativos

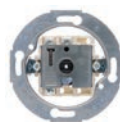

3876 03

#### Interruptores

Descripción	Referencia	Emb.	Precio (€)
<b>Conmutador</b>	3876 03	10	<b>18,80</b>
<b>Cruzamiento</b>	3877 03	1	<b>36,84</b>
<b>Doble interruptor</b>	3875 03	1	<b>23,06</b>
<b>Interruptor bipolar on/off</b>	3893 03	1	<b>35,43</b>

- 10 AX
- Terminales con tornillos

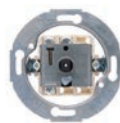

3846 03

#### Pulsadores

Descripción	Referencia	Emb.	Precio (€)
<b>Contacto conmutador</b>	3846 03	1	<b>24,44</b>
<b>De grupo</b>	3838 03	1	<b>30,33</b>

- 10 A, 250 V~
- Terminales con tornillos

### Módulo LED para iluminación



1680 00

#### Módulo LED para iluminación

Descripción	Referencia	Emb.	Precio (€)
<b>Con neutro</b>	1680 00	1	<b>54,51</b>
<b>Sin neutro</b>	1680 01	1	<b>54,51</b>

## Tapas centrales 1930



1647

### Tapas centrales 1930

Descripción	Referencia	Emb.	Precio (€)
<b>Blanco polar, brillo</b>	1647	1	<b>12,52</b>
<b>Negro, brillo</b>	1647 01	1	<b>12,52</b>



1647 69

### Placa central con mando Porzellan made by Rosenthal

Descripción	Referencia	Emb.	Precio (€)
<b>Blanco polar, brillo</b>	1647 69 00	1	<b>46,20</b>
<b>Negro, brillo</b>	1647 65 00	1	<b>77,25</b>

## Mando central



1812 00

### 1930/Glas

Descripción	Referencia	Emb.	Precio (€)
<b>Dorado</b>	1812 00	1	<b>41,35</b>
<b>Cromado</b>	1812 01 00	1	<b>48,12</b>



1812 01 00

## Tapas centrales serie Glas



1090

### Tapas para pulsador/interruptor rotativo

Descripción	Referencia	Emb.	Precio (€)
<b>Tapa, cristal</b>	1090	10	<b>28,83</b>
<b>Tapa cristal, blanco polar</b>	1090 09	10	<b>28,83</b>



1094

<b>Tapa final, cristal</b>	1094	10	<b>32,70</b>
<b>Tapa final, cristal, blanco polar</b>	1094 09	10	<b>32,70</b>



1095

<b>Tapa intermedia, cristal</b>	1095	10	<b>37,97</b>
<b>Tapa intermedia, cristal, blanco polar</b>	1095 09	10	<b>37,97</b>

## Tapas centrales R.classic



1001 20 89

### Tapa central con mando, plástico

Descripción	Referencia	Emb.	Precio (€)
<b>Blanco polar, brillo</b>	1001 20 89 00	1	<b>20,31</b>
<b>Negro, brillo</b>	1001 20 45 00	1	<b>20,31</b>
<b>Aluminio / Blanco polar</b>	1001 20 74 00	1	<b>55,27</b>
<b>Aluminio / Negro</b>	1001 20 84 00	1	<b>55,27</b>
<b>Acero / Blanco polar</b>	1001 20 14 00	1	<b>67,56</b>
<b>Acero / Negro</b>	1001 20 04 00	1	<b>67,56</b>
<b>Cristal / Blanco polar</b>	1001 20 83 00	1	<b>41,58</b>
<b>Cristal / Negro</b>	1001 20 55 00	1	<b>41,58</b>

• No puede instalarse con marcos

**Reguladores rotativos universales con mando**



2944 10

**Serie 1930 / Glas**

Descripción	Referencia	Emb.	Precio (€)
<b>Blanco polar, brillo</b>	2944 10	1	<b>197,43</b>
<b>Negro, brillo</b>	2944 11	1	<b>197,43</b>



2944 20 89

**Serie R.classic**

Descripción	Referencia	Emb.	Precio (€)
<b>Blanco polar, brillo</b>	2944 20 89	1	<b>197,43</b>
<b>Negro, brillo</b>	2944 20 45	1	<b>197,43</b>

**Reg. rotativos universales c/mando - extensión**



2945 10

**Serie 1930 / Glas**

Descripción	Referencia	Emb.	Precio (€)
<b>Blanco polar, brillo</b>	2945 10	1	<b>142,78</b>
<b>Negro, brillo</b>	2945 11	1	<b>142,78</b>



2945 20 89

**Serie R.classic**

Descripción	Referencia	Emb.	Precio (€)
<b>Blanco polar, brillo</b>	2945 20 89	1	<b>142,78</b>
<b>Negro, brillo</b>	2945 20 45	1	<b>142,78</b>

## Interruptor rotativo para persianas, 1 polo

### Serie 1930 / Glas



3811 03

Descripción	Referencia	Emb.	Precio (€)
<b>Blanco polar, brillo</b>	3811 03	1	<b>39,08</b>
<b>Negro, brillo</b>	3811 13	1	<b>39,08</b>

### Serie R.classic



3811 21 89

Descripción	Referencia	Emb.	Precio (€)
<b>Blanco polar, brillo</b>	3811 21 89	1	<b>39,37</b>
<b>Negro, brillo</b>	3811 21 45	1	<b>39,37</b>

## Interruptor rotativo para persianas, 2 polos

### Serie 1930 / Glas



3812 03

Descripción	Referencia	Emb.	Precio (€)
<b>Blanco polar, brillo</b>	3812 03	1	<b>45,22</b>
<b>Negro, brillo</b>	3812 13	1	<b>45,22</b>

### Serie R.classic



3812 21 89

Descripción	Referencia	Emb.	Precio (€)
<b>Blanco polar, brillo</b>	3812 21 89	1	<b>45,55</b>
<b>Negro, brillo</b>	3812 21 45	1	<b>45,55</b>

## Accesorios



1861 01

### Accesorios

Descripción	Referencia	Emb.	Precio (€)
<b>Conversión a pulsador rotativo</b>	1861 01	10	<b>2,82</b>

- Para R.classic

Descripción	Referencia	Emb.	Precio (€)
<b>Conversión a pulsador</b>	1861	10	<b>3,83</b>

- Para mec. persianas  
S/B, Q.x, K.x, Arsys, 1930

## Tapas FCC simples



### Serie 1930 / Glas

Descripción	Referencia	Emb.	Precio (€)
<b>Blanco polar, brillo</b>	1407	10	<b>16,29</b>
<b>Negro, brillo</b>	1407 01	10	<b>16,29</b>

1407



### berker R.classic

Descripción	Referencia	Emb.	Precio (€)
<b>Blanco polar, brillo</b>	1407 20 89	10	<b>6,71</b>
<b>Negro, brillo</b>	1407 20 45	10	<b>7,25</b>

1407 20 89

- mecanismos 4538, 455401, 4586, 4582, 4583, 4588

## Tapas FCC dobles



### Serie 1930 / Glas

Descripción	Referencia	Emb.	Precio (€)
<b>Blanco polar, brillo</b>	1409	10	<b>25,18</b>
<b>Negro, brillo</b>	1409 01	10	<b>25,18</b>

1409

- mecanismos 4539, 455501, 4587



### berker R.classic

Descripción	Referencia	Emb.	Precio (€)
<b>Blanco polar, brillo</b>	1409 20 89	10	<b>6,71</b>
<b>Negro, brillo</b>	1409 20 45	10	<b>7,25</b>

1409 20 89

- mecanismos 4539, 455501, 4587

## Tapas TV 2 elementos



### Serie 1930 / Glas

Descripción	Referencia	Emb.	Precio (€)
<b>Blanco polar, brillo</b>	1039 20	10	<b>7,64</b>
<b>Negro, brillo</b>	1039 21	10	<b>7,64</b>

1039 20

## Tapas TV 3 elementos



### Serie 1930 / Glas

Descripción	Referencia	Emb.	Precio (€)
<b>Blanco polar, brillo</b>	1064 20	10	<b>25,18</b>
<b>Negro, brillo</b>	1064 21	10	<b>25,18</b>

1064 20

## Tapas TV con 2 o 3 elementos



### berker R. classic

Descripción	Referencia	Emb.	Precio (€)
<b>Blanco polar, brillo</b>	1203 20 89	10	<b>6,71</b>
<b>Negro, brillo</b>	1203 20 45	10	<b>7,25</b>

1203 20 89

## Tapas TV con 4 elementos



### berker R. classic

Descripción	Referencia	Emb.	Precio (€)
<b>Blanco polar, brillo</b>	1484 20 89	10	<b>6,71</b>
<b>Negro, brillo</b>	1484 20 45	10	<b>7,25</b>

1484 20 89

## Tapa conector mini con bastidor



### Serie 1930 / Glas

Descripción	Referencia	Emb.	Precio (€)
<b>Blanco polar, brillo</b>	4508 20	10	<b>40,10</b>
<b>Negro, brillo</b>	4508 21	10	<b>40,10</b>

4508 20



### Serie R. classic

Descripción	Referencia	Emb.	Precio (€)
<b>Blanco polar, brillo</b>	1196 20 79	10	<b>22,80</b>
<b>Negro, brillo</b>	1196 20 35	10	<b>22,80</b>

1196 20 79

## Toma USB 230V



### Toma USB 230V

Descripción	Referencia	Emb.	Precio (€)
<b>Blanco polar, brillo</b>	2602 19	10	<b>67,93</b>
<b>Negro, brillo</b>	2602 15	1	<b>67,93</b>

2602 19

## LED señalización blanco



### LED señalización blanco

Descripción	Referencia	Emb.	Precio (€)
<b>R.classic, blanco polar brillo</b>	2953 20 89	1	<b>108,47</b>
<b>R.classic, negro brillo</b>	2953 20 45	1	<b>108,68</b>

2953 20 89

- Para señalar información o avisos
- Luminosidad ajustable via potenciómetro
- Control vía interruptor separado
- Se pueden insertar films con símbolos
- Color blanco frío
- Estética incorporada

## Tapas tomas USB



### Serie 1930 / Glas

Descripción	Referencia	Emb.	Precio (€)
<b>Blanco polar, brillo</b>	1040	10	<b>20,44</b>
<b>Negro, brillo</b>	1040 01	10	<b>20,44</b>

1040



### berker R.classic

Descripción	Referencia	Emb.	Precio (€)
<b>Blanco polar, brillo</b>	1038 20 89	10	<b>6,71</b>
<b>Negro, brillo</b>	1038 20 45	10	<b>7,25</b>

1038 20 89

## LED señalización rojo/verde



### LED señalización rojo/verde

Descripción	Referencia	Emb.	Precio (€)
<b>R.classic, blanco polar</b>	2952 20 89	1	<b>122,40</b>
<b>R.classic, negro</b>	2952 20 45	1	<b>122,58</b>

2952 20 89

- Para señalización de control de accesos
- Activación de verde y rojo mediante interruptores separados
- Incluye 2 films de «no molestar/limpiar» y «espere/pase»
- Estética incorporada

## Lámparas piloto



### Pulsador con lámpara piloto

Descripción	Referencia	Emb.	Precio (€)
<b>Blanco polar, brillo, contacto NO</b>	5104	1	<b>26,44</b>
<b>Negro, brillo, contacto NO</b>	5104 01	1	<b>26,44</b>

5104



### Accesorios, mando para pulsador y piloto E10

Descripción	Referencia	Emb.	Precio (€)
<b>Blanco polar, brillo</b>	1225	10	<b>9,52</b>
<b>Negro, brillo</b>	1225 01	10	<b>9,52</b>
<b>Símbolo luz, blanco polar, brillo</b>	1226	10	<b>21,06</b>
<b>Símbolo campana, blanco polar, brillo</b>	1227	10	<b>20,44</b>
<b>Rojo, transparente</b>	1229	10	<b>21,30</b>
<b>Transparente</b>	1229 02	10	<b>21,30</b>

1225



### Accesorios, tapa

Descripción	Referencia	Emb.	Precio (€)
<b>Transparente</b>	1221	10	<b>19,03</b>
<b>Rojo</b>	1222	10	<b>20,91</b>

1221

## Tarjetero hotel



### Serie 1930 / R.classic

Descripción	Referencia	Emb.	Precio (€)
<b>Blanco polar, brillo</b>	1640 20 79	10	<b>81,49</b>
<b>Negro, brillo</b>	1640 20 35	1	<b>81,49</b>

1640 20 79

## Film para LED señalización



### LED señalización redondo

Descripción	Referencia	Emb.	Precio (€)
<b>Hombre</b>	1905 80 06	1	<b>10,98</b>
<b>Mujer</b>	1905 80 07	1	<b>10,98</b>
<b>Silla de ruedas</b>	1905 80 08	1	<b>10,98</b>
<b>Escaleras</b>	1905 80 09	1	<b>10,98</b>
<b>Ascensor</b>	1905 80 10	1	<b>10,98</b>

1905 80 03

## Film para LED señalización rojo/verde



### Film para LED rojo/verde redondo

Descripción	Referencia	Emb.	Precio (€)
<b>Símbolo no molestar/limpiar</b>	1905 80 13	1	<b>12,32</b>
<b>Símbolo espere/pase</b>	1905 80 14	1	<b>12,32</b>

1905 80 13

## Tapas ciegas



### Serie 1930 / Glas

Descripción	Referencia	Emb.	Precio (€)
<b>Blanco polar, brillo</b>	1009 20	20	<b>34,33</b>
<b>Negro, brillo, sin garras</b>	1009 21	20	<b>34,33</b>

1009 20



### Serie R.classic

Descripción	Referencia	Emb.	Precio (€)
<b>Blanco polar, brillo</b>	1009 20 79	20	<b>21,56</b>
<b>Negro, brillo</b>	1009 20 35	20	<b>21,56</b>

1009 20 79

## Tapas ciegas con base y garras



### Serie 1930 / Glas

Descripción	Referencia	Emb.	Precio (€)
<b>Blanco polar, brillo</b>	67 1009 20	10	<b>34,22</b>
<b>Negro</b>	67 1009 21	10	<b>34,22</b>

67 1009 20

## Tapas salida de cables



### Serie 1930 / Glas

Descripción	Referencia	Emb.	Precio (€)
<b>Blanco polar, brillo</b>	1037	10	<b>11,65</b>
<b>Negro, brillo</b>	1037 01	10	<b>11,65</b>

1037



### berker R.1 / R.3 / R.classic

Descripción	Referencia	Emb.	Precio (€)
<b>Blanco polar, brillo</b>	1019 20 89	10	<b>6,71</b>
<b>Negro, brillo</b>	1019 20 45	10	<b>7,25</b>

1019 20 89

## Accesorios - separador



### Serie 1930 / Glas

Descripción	Referencia	Emb.	Precio (€)
<b>Rojo</b>	1887	100	<b>1,10</b>

1887

Toma SCHUKO® con cargador USB

# Solución compacta

## ¿Carga flexible en todas partes?

Con las nuevas tomas Schuko con cargadores USB tipo A y C, carga tres dispositivos a la vez si es necesario. Puedes conectar, por ejemplo, una lámpara de mesa en la toma Schuko, mientras se carga un teléfono móvil con conector USB-A así como una tableta con conector USB-C. Ahorra tiempo y espacio con esta solución 3 en 1, perfecta para el hogar, los negocios y el área pública. Disponible en varias estéticas de las series berker, para que elijas la que mejor se adapte a tu estilo.

[hager.es/berker](http://hager.es/berker)



:hager

# Hager Manufaktur

Manufaktur es un servicio de Hager Group de fabricación especial. Nuestros productos se fabrican al más alto nivel con materiales, colores, acabados y funciones individualizados. Los controles de calidad garantizan la perfección. Un ejemplo son los interruptores que Miriam Alía ha diseñado para Hager. Fabricados a partir del diseño creado por Miriam, con los dos tonos de color específicos para las teclas que otorgan al proyecto un acabado exclusivo.

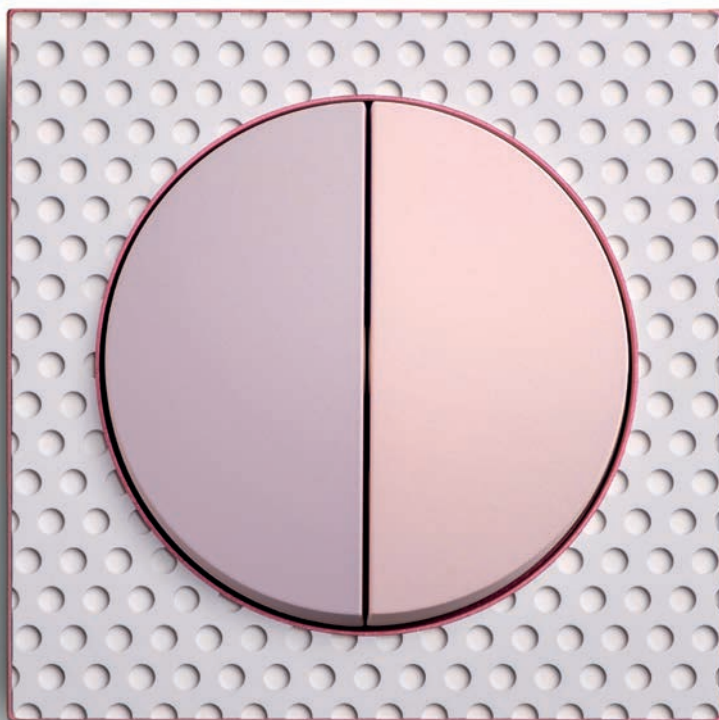

# Manufaktur

pág.

---

Presentación Manufaktur	168
Manufaktur Edition	170
Manufaktur by Miriam Alía	172

---



# Acabados exclusivos

En berker Manufaktur, todos nuestros productos pueden imprimirse o fabricarse en materiales de alta gama. Y les aplicamos numerosos tratamientos únicos y específicos. El objetivo último es llegar a una solución exclusiva.



berker B.IQ,  
con símbolos serigrafiados en láser



berker TS,  
latón marrón



berker TS,  
cristal negro, con toma  
de corriente



berker R.classic,  
crystal Polarwit

# ¡Único!

## Manufaktur edition

¿Puede algo único hacerse "más único"? La unicidad no solemos cuantificarla. Nuestros diseñadores, pero, ven las cosas de manera diferente y plasman las últimas tendencias de diseño en algo que realmente es más único: Los siguientes acabados son un ejemplo.

**berker series 1930,  
negro, mate**

- Tacto aterciopelado gracias a un recubrimiento soft-touch



**berker R.1 cobre cepillado**

- Sin oxidación gracias a un recubrimiento especial



**berker R.3 acero inoxidable  
cromo negro, mate**

- Acabado mate realizado a mano

**berker K.5 latón cepillado**



# Tonos pastel berker Q.7 colores minerales

Los tonos pastel en los espacios de vida ya no son exóticos. En los próximos años, esta tendencia "se hará cada vez más fuerte". Estos son algunos ejemplos para la serie berker Q.7: ocho colores minerales que aportan una nueva elegancia.

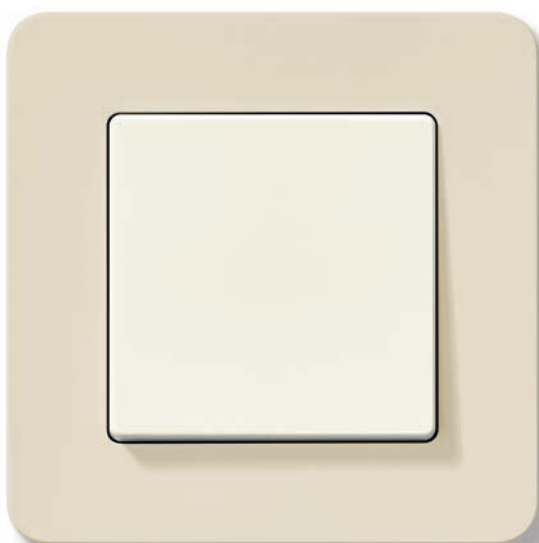

01

**berker Q.7**  
Colores minerales



02



03



04



05



06



07



08

**Colores:**

- 01 arena
- 02 guijarro
- 03 cuarzo rosa
- 04 menta
- 05 verde
- 06 basalto
- 07 cobalto
- 08 azul



[hager.es/manufaktur](http://hager.es/manufaktur)



### Conjunto completo tecla simple



MAH01

#### Conjunto completo tecla simple by Miriam Alía

Descripción	Referencia	Emb.	Precio (€)
<b>Conjunto tecla simple</b>	MAH01	1	<b>199,95</b>

**Conjunto tecla simple**

- Composición producto:
  - tecla simple
  - marco
  - mecanismo

### Conjunto completo tecla doble



MAH02

#### Conjunto completo tecla doble by Miriam Alía

Descripción	Referencia	Emb.	Precio (€)
<b>Conjunto tecla doble</b>	MAH02	1	<b>214,98</b>

**Conjunto tecla doble**

- Composición producto:
  - tecla doble
  - marco
  - mecanismo



Manufaktur

Manufaktur by  
MIRIAM ALÍA  
*life - style*

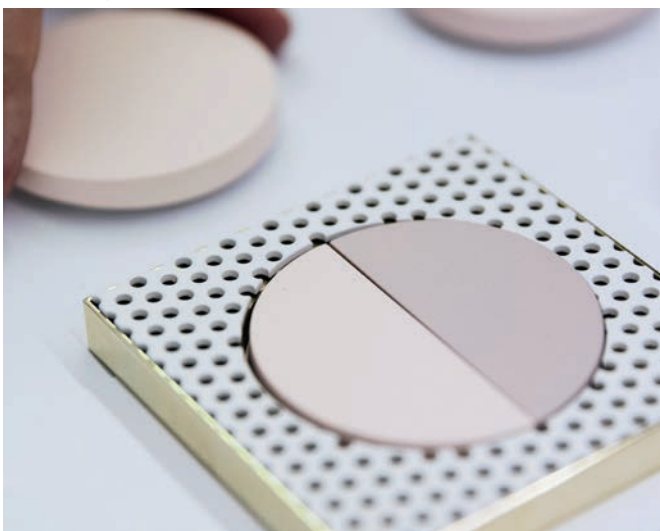

No se admiten devoluciones en esta familia de producto (97)

# Series técnicas: industriales y estancas Integro y cubyko IP55

La gama industrial ofrece el sistema Integro de diseño ultracompacto, instalación rápida sin herramientas especiales e integración de sistemas de comunicación. Adecuada para caravanas, instalaciones en barco, construcción naval y laboratorios. Los mecanismos estancos cubyko IP55 se distinguen por su premiado y refinado diseño que se adapta a todos los entornos y resiste todas las estaciones.



# Series técnicas

pág.

---

berker Integro	176
cubyko IP55	184

---



# berker Integro

Con su diseño ultracompacto y con una profundidad de instalación mínima, berker Integro es adecuado para espacios pequeños y para uso en caravanas o construcción de muebles así como para responder a las exigencias especiales de instalación en barcos, construcciones navales y laboratorios.

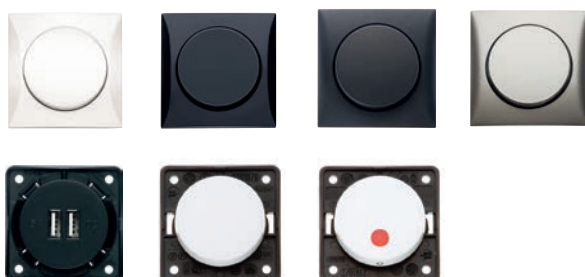

## Marcos



9 1827 25 09

## 1 elemento

Descripción	Referencia	Emb.	Precio (€)
<b>Marrón, mate</b>	9 1827 25 01	10	<b>1,45</b>
<b>Antracita, mate</b>	9 1827 25 05	10	<b>1,45</b>
<b>Gris, brillo</b>	9 1827 25 07	10	<b>1,45</b>
<b>Blanco polar, brillo</b>	9 1827 25 09	10	<b>1,45</b>
<b>Negro, brillo</b>	9 1827 25 10	10	<b>1,45</b>
<b>Rojo</b>	9 1827 25 76	1	<b>1,32</b>
<b>Cromo, mate</b>	9 1827 25 58	1	<b>16,25</b>
<b>Cromo, brillo</b>	9 1827 25 18	1	<b>14,77</b>
<b>Acero</b>	9 1827 25 24	10	<b>16,25</b>



9 1826 25 19

## 2 elementos

Descripción	Referencia	Emb.	Precio (€)
<b>Marrón, mate</b>	9 1826 25 11	2	<b>3,48</b>
<b>Antracita, mate</b>	9 1826 25 15	2	<b>3,48</b>
<b>Gris, brillo</b>	9 1826 25 07	2	<b>3,48</b>
<b>Blanco polar, brillo</b>	9 1826 25 19	2	<b>3,48</b>
<b>Negro, brillo</b>	9 1826 25 10	2	<b>3,48</b>
<b>Cromo, mate</b>	9 1826 25 58	2	<b>20,71</b>
<b>Acero</b>	9 1826 25 24	2	<b>20,71</b>



9 1819 25 19

## 3 elementos

Descripción	Referencia	Emb.	Precio (€)
<b>Marrón, mate</b>	9 1819 25 11	2	<b>5,17</b>
<b>Antracita, mate</b>	9 1819 25 15	2	<b>5,17</b>
<b>Gris, brillo</b>	9 1819 25 07	2	<b>5,17</b>
<b>Blanco polar, brillo</b>	9 1819 25 19	2	<b>5,17</b>
<b>Negro, brillo</b>	9 1819 25 10	2	<b>5,17</b>
<b>Cromo, mate</b>	9 1819 25 68	2	<b>27,63</b>
<b>Acero</b>	9 1819 25 24	2	<b>27,63</b>



9 1803 25 09

## 1 elemento con portaetiquetas

Descripción	Referencia	Emb.	Precio (€)
<b>Antracita, mate</b>	9 1803 25 05	10	<b>7,95</b>
<b>Gris, brillo</b>	9 1803 25 07	10	<b>7,95</b>
<b>Blanco polar, brillo</b>	9 1803 25 09	10	<b>7,95</b>
<b>Cromo, mate</b>	9 1803 25 68	10	<b>27,79</b>



9 1827 25 99

## 1 elemento con impresión IP44

Descripción	Referencia	Emb.	Precio (€)
<b>Marrón, mate</b>	9 1827 25 91	10	<b>1,61</b>
<b>Antracita, mate</b>	9 1827 25 95	10	<b>1,61</b>
<b>Gris, brillo</b>	9 1827 25 97	10	<b>1,61</b>
<b>Blanco polar, brillo</b>	9 1827 25 99	10	<b>1,61</b>
<b>Cromo, mate</b>	9 1827 25 68	10	<b>19,31</b>



9 1828 25 09

## 1 elemento con tapa

Descripción	Referencia	Emb.	Precio (€)
<b>Marrón, mate</b>	9 1828 25 01	10	<b>5,16</b>
<b>Antracita, mate</b>	9 1828 25 05	10	<b>5,16</b>
<b>Gris, brillo</b>	9 1828 25 07	10	<b>5,16</b>
<b>Blanco polar, brillo</b>	9 1828 25 09	10	<b>5,16</b>
<b>Negro, brillo</b>	9 1828 25 10	10	<b>5,16</b>
<b>Cromo, mate</b>	9 1828 25 78	10	<b>22,78</b>
<b>Acero</b>	9 1828 25 24	10	<b>22,78</b>
<b>Rojo</b>	9 1828 25 76	10	<b>6,29</b>



9 1988 25 02

## 1 elemento con tapa y portaetiquetas

Descripción	Referencia	Emb.	Precio (€)
<b>Antracita, mate</b>	9 1988 25 05	10	<b>16,52</b>
<b>Gris, brillo</b>	9 1988 25 06	10	<b>16,52</b>
<b>Blanco polar, brillo</b>	9 1988 25 02	10	<b>16,52</b>
<b>Naranja</b>	9 1988 25 04	10	<b>16,52</b>
<b>Rojo</b>	9 1988 25 76	10	<b>16,52</b>



9 1828 25 99

## 1 elemento con tapa e impresión IP44

Descripción	Referencia	Emb.	Precio (€)
<b>Marrón, mate</b>	9 1828 25 91	10	<b>6,74</b>
<b>Antracita, mate</b>	9 1828 25 95	10	<b>6,74</b>
<b>Gris, brillo</b>	9 1828 25 97	10	<b>6,74</b>
<b>Blanco polar, brillo</b>	9 1828 25 99	10	<b>6,74</b>
<b>Cromo, mate</b>	9 1828 25 68	10	<b>23,60</b>
<b>Rojo</b>	9 1828 25 86	10	<b>6,74</b>
<b>Verde</b>	9 1828 25 90	10	<b>6,74</b>



9 4516 25 09

## Tapa ciega

Descripción	Referencia	Emb.	Precio (€)
<b>Marrón, mate</b>	9 4516 25 01	10	<b>3,84</b>
<b>Antracita, mate</b>	9 4516 25 05	10	<b>3,84</b>
<b>Gris, brillo</b>	9 4516 25 07	10	<b>3,84</b>
<b>Blanco polar, brillo</b>	9 4516 25 09	10	<b>3,84</b>
<b>Negro, brillo</b>	9 4516 25 10	10	<b>3,84</b>
<b>Cromo, mate</b>	8 4516 25 68	200	<b>15,49</b>
<b>Acero</b>	9 4516 25 24	10	<b>15,49</b>

## Toma SCHUKO



9 4195 25 02

Descripción	Referencia	Emb.	Precio (€)
<b>Marrón, mate</b>	9 4195 25 01	10	<b>11,39</b>
<b>Antracita, mate</b>	9 4195 25 05	10	<b>11,39</b>
<b>Gris, mate</b>	9 4195 25 06	10	<b>11,39</b>
<b>Blanco polar, mate</b>	9 4195 25 02	10	<b>11,39</b>
<b>Negro, mate</b>	9 4195 05	10	<b>11,39</b>

- 16A, 250 V
- Protección infantil
- Conexión por tornillos

## Tomas de corriente



9 6184 25 02

### Toma Países Bajos

Descripción	Referencia	Emb.	Precio (€)
<b>Marrón, mate</b>	9 6184 25 01	10	<b>12,02</b>
<b>Negro, mate</b>	9 6184 05	10	<b>12,02</b>

- Tornillo con elevador



9 6194 25 02

### Toma Países Bajos

Descripción	Referencia	Emb.	Precio (€)
<b>Antracita, mate</b>	9 6194 25 05	10	<b>13,60</b>
<b>Gris, mate</b>	9 6194 25 06	10	<b>13,60</b>
<b>Blanco polar, mate</b>	9 6194 25 02	10	<b>13,60</b>
<b>Negro, mate</b>	9 6194 05	10	<b>13,60</b>

- Tornillo con elevador
- Protección infantil



9 6257 25 02

### Toma EURO-AMERICANA STANDARD

Descripción	Referencia	Emb.	Precio (€)
<b>Marrón, mate</b>	9 6257 25 01	10	<b>19,11</b>
<b>Antracita, mate</b>	9 6257 25 05	10	<b>19,11</b>
<b>Gris, mate</b>	9 6257 25 06	10	<b>19,11</b>
<b>Blanco polar, mate</b>	9 6257 25 02	10	<b>19,11</b>
<b>Negro, mate</b>	9 6257 25 03	10	<b>19,11</b>



9 6185 25 02

### Toma con pin de tierra

Descripción	Referencia	Emb.	Precio (€)
<b>Marrón, mate</b>	9 6185 25 01	10	<b>11,54</b>
<b>Antracita, mate</b>	9 6185 25 05	10	<b>11,54</b>
<b>Gris, mate</b>	9 6185 25 06	10	<b>11,54</b>
<b>Blanco polar, mate</b>	9 6185 25 02	10	<b>11,54</b>
<b>Negro, mate</b>	9 6185 05	10	<b>11,54</b>



9 6195 25 02

### Toma Francia/Bélgica

Descripción	Referencia	Emb.	Precio (€)
<b>Marrón, mate</b>	9 6195 25 01	10	<b>12,12</b>
<b>Antracita, mate</b>	9 6195 25 05	10	<b>12,12</b>
<b>Gris, mate</b>	9 6195 25 06	10	<b>12,12</b>
<b>Blanco polar, mate</b>	9 6195 25 02	10	<b>12,12</b>
<b>Negro, mate</b>	9 6195 05	10	<b>12,12</b>

- Tornillo con elevador
- Protección infantil



8 6263 25 02

### Toma USA/CANADA NEMA 5-15 R

Descripción	Referencia	Emb.	Precio (€)
<b>Blanco polar, mate</b>	8 6263 25 02	200	<b>28,11</b>
<b>Negro, mate*</b>	8 6263 25 13	200	<b>28,11</b>
<b>Marrón, mate</b>	8 6263 25 01	200	<b>28,11</b>

- Zona central color marrón



8 6254 25 09

### Toma USA/CANADA NEMA 6-20 R

Descripción	Referencia	Emb.	Precio (€)
<b>Marrón, mate</b>	8 6254 25 01	200	<b>107,27</b>
<b>Antracita, mate</b>	8 6254 25 05	200	<b>107,27</b>
<b>Gris, mate</b>	8 6254 25 07	200	<b>107,27</b>
<b>Blanco polar, mate</b>	8 6254 25 09	200	<b>107,27</b>
<b>Negro, mate</b>	8 6254 25 10	200	<b>107,27</b>



9 6256 25 02

### Toma Australia 15A

Descripción	Referencia	Emb.	Precio (€)
<b>Marrón, mate</b>	9 6256 25 01	10	<b>62,99</b>
<b>Antracita, mate</b>	9 6256 25 05	10	<b>62,99</b>
<b>Gris, mate</b>	9 6256 25 06	10	<b>62,99</b>
<b>Blanco polar, mate</b>	9 6256 25 02	10	<b>62,99</b>
<b>Negro, mate</b>	9 6256 05	10	<b>62,99</b>



9 6272 25 02

### Toma Dinamarca

Descripción	Referencia	Emb.	Precio (€)
<b>Antracita, mate</b>	9 6272 25 05	10	<b>19,97</b>
<b>Gris, mate</b>	9 6272 25 06	10	<b>19,97</b>
<b>Blanco polar, mate</b>	9 6272 25 02	10	<b>19,97</b>
<b>Negro, mate</b>	9 6272 05	10	<b>19,97</b>



9 6249 25 02

### Toma Suiza Tipo 13

Descripción	Referencia	Emb.	Precio (€)
<b>Marrón, mate</b>	9 6249 25 01	10	<b>28,11</b>
<b>Antracita, mate</b>	9 6249 25 05	10	<b>28,11</b>
<b>Gris, mate</b>	9 6249 25 06	10	<b>28,11</b>
<b>Blanco polar, mate</b>	9 6249 25 02	10	<b>28,11</b>
<b>Negro, mate</b>	9 6249 05	10	<b>28,11</b>



9 6259 25 02

### Toma Suiza Tipo 23

Descripción	Referencia	Emb.	Precio (€)
<b>Marrón, mate</b>	9 6259 25 01	10	<b>28,11</b>
<b>Antracita, mate</b>	9 6259 25 05	10	<b>28,11</b>
<b>Gris, mate</b>	9 6259 25 06	10	<b>28,11</b>
<b>Blanco polar, mate</b>	9 6259 25 02	10	<b>28,11</b>
<b>Negro, mate</b>	9 6259 25 03	10	<b>28,11</b>



9 6262 25 02

### Toma BRITISH STANDARD

Descripción	Referencia	Emb.	Precio (€)
<b>Marrón, mate</b>	9 6262 25 01	10	<b>18,49</b>
<b>Antracita, mate</b>	9 6262 25 05	10	<b>18,49</b>
<b>Gris, mate</b>	9 6262 25 06	10	<b>18,49</b>
<b>Blanco polar, mate</b>	9 6262 25 02	10	<b>18,49</b>
<b>Negro, mate</b>	9 6262 05	10	<b>18,49</b>

## Conectores



9 4517 05

## Conector 12V

Descripción	Referencia	Emb.	Precio (€)
<b>Marrón, mate</b>	9 4517 25 01	10	<b>20,70</b>
<b>Antracita, mate</b>	9 4517 25 05	10	<b>20,70</b>
<b>Gris, mate</b>	9 4517 25 07	10	<b>20,70</b>
<b>Blanco polar, mate</b>	9 4517 25 09	10	<b>20,70</b>
<b>Negro, mate</b>	9 4517 05	10	<b>20,70</b>

• Para enchufe 12 V, ref. 4637



8 4571 25 09

## Toma 12V

Descripción	Referencia	Emb.	Precio (€)
<b>Marrón, mate</b>	8 4571 25 01	200	<b>14,83</b>
<b>Antracita, mate</b>	8 4571 25 05	200	<b>14,83</b>
<b>Gris, brillo</b>	8 4571 25 07	200	<b>14,83</b>
<b>Blanco polar, brillo</b>	8 4571 25 09	200	<b>14,83</b>
<b>Negro, mate</b>	8 4571 25 03	200	<b>14,83</b>



4637

## Enchufe 12V

Descripción	Referencia	Emb.	Precio (€)
<b>Negro, mate</b>	4637	1	<b>4,92</b>



9 2600 25 09

## Toma carga USB

Descripción	Referencia	Emb.	Precio (€)
<b>Antracita, mate</b>	9 2610 25 05	1	<b>118,50</b>
<b>Blanco polar, mate</b>	9 2610 25 09	1	<b>118,50</b>

## TV / Audio / Video



9 4511 25 12

## Toma TV box TV

Descripción	Referencia	Emb.	Precio (€)
<b>Marrón, mate, conexión solder</b>	9 4511 25 11	10	<b>7,69</b>
<b>Antracita, mate, conexión solder</b>	9 4511 25 15	10	<b>7,69</b>
<b>Gris, mate, conexión solder</b>	9 4511 25 16	10	<b>7,69</b>
<b>Blanco polar, mate, conexión solder</b>	9 4511 25 12	10	<b>7,69</b>
<b>Negro, mate, conexión solder</b>	9 4511 15	10	<b>7,69</b>
<b>Marrón, mate, conexión F</b>	9 4581 25 01	10	<b>11,22</b>
<b>Antracita, mate, conexión F</b>	9 4581 25 05	10	<b>11,22</b>
<b>Gris, mate, conexión F</b>	9 4581 25 06	10	<b>11,22</b>
<b>Blanco polar, mate, conexión F</b>	9 4581 25 02	10	<b>11,22</b>
<b>Negro, mate, conexión F</b>	9 4581 25 03	10	<b>11,22</b>



9 4519 25 02

## Toma TV box SAT

Descripción	Referencia	Emb.	Precio (€)
<b>Marrón, mate</b>	9 4519 25 01	10	<b>10,75</b>
<b>Antracita, mate</b>	9 4519 25 05	10	<b>10,75</b>
<b>Gris, mate</b>	9 4519 25 06	10	<b>10,75</b>
<b>Blanco polar, mate</b>	9 4519 25 02	10	<b>10,75</b>
<b>Negro, mate</b>	9 4519 05	10	<b>10,75</b>



9 4560 25 02

## Toma TV box radio/SAT

Descripción	Referencia	Emb.	Precio (€)
<b>Marrón, mate</b>	9 4560 25 01	10	<b>21,32</b>
<b>Antracita, mate</b>	9 4560 25 05	10	<b>21,32</b>
<b>Gris, mate</b>	9 4560 25 06	10	<b>21,32</b>
<b>Blanco polar, mate</b>	9 4560 25 02	10	<b>21,32</b>
<b>Negro, mate</b>	9 4560 05	10	<b>21,32</b>



9 4561 25 02

## Toma TV box TV/radio

Descripción	Referencia	Emb.	Precio (€)
<b>Blanco polar, mate</b>	9 4561 25 02	10	<b>21,32</b>



8 4563 25 06

## Toma TV box TV/SAT

Descripción	Referencia	Emb.	Precio (€)
<b>Gris, mate</b>	8 4563 25 06	200	<b>23,83</b>
<b>Negro, mate</b>	8 4563 25 03	200	<b>23,83</b>



1992

## Cinch video

Descripción	Referencia	Emb.	Precio (€)
<b>Blanco polar/amarillo</b>	1992	1	<b>32,77</b>



1994

## Módulo VGA

Descripción	Referencia	Emb.	Precio (€)
<b>Blanco polar/negro</b>	1994	1	<b>122,86</b>



1993

## Módulo S-Video

Descripción	Referencia	Emb.	Precio (€)
<b>Blanco polar/negro</b>	1993	1	<b>55,96</b>



1990

## Módulo 1 elemento

Descripción	Referencia	Emb.	Precio (€)
<b>Blanco polar</b>	1990	1	<b>5,53</b>

## Datos / Telecomunicaciones



9 4559 25 09

## Soporte para 2 módulos MINI-COM

Descripción	Referencia	Emb.	Precio (€)
<b>Antracita, brillo</b>	9 4559 25 05	10	<b>3,85</b>
<b>Gris, brillo</b>	9 4559 25 07	10	<b>3,85</b>
<b>Blanco polar, brillo</b>	9 4559 25 09	10	<b>3,85</b>
<b>Negro, brillo</b>	9 4559 05	10	<b>3,85</b>



1985

## Mini jack 8 polos

Descripción	Referencia	Emb.	Precio (€)
<b>Negro, RJ45, cat.3, compatible RDSI (AWG 24-22)</b>	1980	1	<b>23,51</b>
<b>RJ45, cat.5e, apantallado (AWG 24-22)</b>	1984	1	<b>32,14</b>
<b>RJ45, cat.6, apantallado (AWG 26)</b>	1985	1	<b>37,28</b>



9 4557 25 09

## Soporte para jacks modulares AMP 1 elemento

Descripción	Referencia	Emb.	Precio (€)
<b>Antracita, brillo</b>	9 4557 25 05	10	<b>3,06</b>
<b>Gris, brillo</b>	9 4557 25 07	10	<b>3,06</b>
<b>Blanco polar, brillo</b>	9 4557 25 09	10	<b>4,16</b>
<b>Negro, brillo</b>	9 4557 05	10	<b>4,16</b>

• Ref. AMP 1375188-1



8 4558 25 09

## Soporte para módulos 2 BTR-/E-DAT

Descripción	Referencia	Emb.	Precio (€)
<b>Negro, brillo</b>	8 4558 25 10	100	<b>8,55</b>
<b>Antracita, brillo</b>	8 4558 25 05	100	<b>8,55</b>
<b>Gris, brillo</b>	8 4558 25 07	100	<b>8,55</b>
<b>Blanco polar, brillo</b>	8 4558 25 09	100	<b>8,55</b>

## Interruptores



9 3656 25 09

### Conmutador 16AX, 250V

Descripción	Referencia	Emb.	Precio (€)
<b>Marrón, mate</b>	9 3656 25 01	10	<b>13,79</b>
<b>Antracita, mate</b>	9 3656 25 05	10	<b>13,79</b>
<b>Gris, brillo</b>	9 3656 25 07	10	<b>13,79</b>
<b>Blanco polar, brillo</b>	9 3656 25 09	10	<b>13,79</b>
<b>Negro, brillo</b>	9 3656 25 10	10	<b>13,79</b>
<b>Cromo, mate</b>	9 3656 25 68	10	<b>25,86</b>
<b>Acero</b>	9 3656 25 24	10	<b>25,86</b>



9 3657 25 01

### Cruzamiento, 16AX, 250V

Descripción	Referencia	Emb.	Precio (€)
<b>Antracita, mate</b>	9 3657 25 05	10	<b>24,87</b>
<b>Gris, brillo</b>	9 3657 25 07	10	<b>24,87</b>
<b>Blanco polar, brillo</b>	9 3657 25 09	10	<b>24,87</b>
<b>Negro, brillo</b>	9 3657 25 10	10	<b>24,87</b>
<b>Acero</b>	9 3657 25 24	10	<b>33,79</b>



9 3652 25 09

### 2 polos Off, 16AX, 250V

Descripción	Referencia	Emb.	Precio (€)
<b>Marrón, mate</b>	9 3652 25 01	10	<b>17,97</b>
<b>Antracita, mate</b>	9 3652 25 05	10	<b>17,97</b>
<b>Gris, brillo</b>	9 3652 25 07	10	<b>17,97</b>
<b>Blanco polar, brillo</b>	9 3652 25 09	10	<b>17,97</b>
<b>Negro, brillo</b>	9 3652 25 10	10	<b>17,97</b>
<b>Cromo, mate</b>	9 3652 25 68	10	<b>36,38</b>
<b>Acero</b>	9 3652 25 24	10	<b>36,38</b>



9 3752 25 09

### 2 polos Off con indicador luminoso, 16AX, 250V

Descripción	Referencia	Emb.	Precio (€)
<b>Marrón, mate</b>	9 3752 25 01	10	<b>23,43</b>
<b>Antracita, mate</b>	9 3752 25 05	10	<b>23,43</b>
<b>Gris, brillo</b>	9 3752 25 07	10	<b>23,43</b>
<b>Blanco polar, brillo</b>	9 3752 25 09	10	<b>23,43</b>
<b>Negro, brillo</b>	9 3752 25 10	10	<b>23,43</b>
<b>Cromo, mate</b>	9 3752 25 68	10	<b>28,99</b>
<b>Acero</b>	9 3752 25 24	10	<b>28,99</b>



9 3762 25 39

### 2 polos Off con indicador luminoso, 5A, 12V=

Descripción	Referencia	Emb.	Precio (€)
<b>Marrón, mate</b>	9 3762 25 31	10	<b>50,66</b>
<b>Antracita, mate</b>	9 3762 25 35	10	<b>50,66</b>
<b>Blanco polar, brillo</b>	9 3762 25 39	10	<b>50,66</b>
<b>Negro, brillo</b>	9 3762 25 10	10	<b>50,66</b>
<b>Cromo, mate</b>	9 3762 25 68	10	<b>60,15</b>
<b>Acero</b>	9 3762 25 24	10	<b>60,15</b>



9 3655 25 09

### Interruptor doble, 16AX, 250V

Descripción	Referencia	Emb.	Precio (€)
<b>Marrón, mate</b>	9 3655 25 01	10	<b>18,44</b>
<b>Antracita, mate</b>	9 3655 25 05	10	<b>18,44</b>
<b>Gris, brillo</b>	9 3655 25 07	10	<b>18,44</b>
<b>Blanco polar, brillo</b>	9 3655 25 09	10	<b>18,44</b>
<b>Negro, brillo</b>	9 3655 25 10	10	<b>18,44</b>
<b>Cromo, mate</b>	9 3655 25 68	10	<b>37,97</b>
<b>Acero</b>	9 3655 25 24	10	<b>37,97</b>

## Pulsadores



9 3671 25 09

### Pulsador contacto NA, 10A, 250V

Descripción	Referencia	Emb.	Precio (€)
<b>Marrón, mate</b>	9 3671 25 01	10	<b>11,86</b>
<b>Antracita, mate</b>	9 3671 25 05	10	<b>11,86</b>
<b>Gris, brillo</b>	9 3671 25 07	10	<b>11,86</b>
<b>Blanco polar, brillo</b>	9 3671 25 09	10	<b>11,86</b>
<b>Negro, brillo</b>	9 3671 25 10	10	<b>11,86</b>
<b>Cromo, mate</b>	9 3671 25 68	10	<b>25,81</b>
<b>Acero</b>	9 3671 25 24	10	<b>25,81</b>



9 3772 25 09

### Pulsador con indicador luminoso, 10A 250V

Descripción	Referencia	Emb.	Precio (€)
<b>Marrón, mate</b>	9 3772 25 01	10	<b>26,76</b>
<b>Antracita, mate</b>	9 3772 25 05	10	<b>26,76</b>
<b>Gris, brillo</b>	9 3772 25 07	10	<b>26,76</b>
<b>Blanco polar, brillo</b>	9 3772 25 09	10	<b>26,76</b>



9 3675 25 09

### Pulsador doble, 2 NA, 10A, 250V

Descripción	Referencia	Emb.	Precio (€)
<b>Marrón, mate</b>	9 3675 25 01	10	<b>20,36</b>
<b>Antracita, mate</b>	9 3675 25 05	10	<b>20,36</b>
<b>Gris, brillo</b>	9 3675 25 07	10	<b>20,36</b>
<b>Blanco polar, brillo</b>	9 3675 25 09	10	<b>20,36</b>
<b>Negro, brillo</b>	9 3675 25 10	10	<b>20,36</b>
<b>Cromo, mate</b>	9 3675 25 68	10	<b>44,37</b>
<b>Acero</b>	9 3675 25 24	10	<b>44,37</b>



9 3653 25 09

### Pulsador doble para persianas

Descripción	Referencia	Emb.	Precio (€)
<b>Marrón, mate</b>	9 3653 25 01	10	<b>18,49</b>
<b>Antracita, mate</b>	9 3653 25 05	10	<b>18,49</b>
<b>Gris, brillo</b>	9 3653 25 07	10	<b>18,49</b>
<b>Blanco polar, brillo</b>	9 3653 25 09	10	<b>18,49</b>
<b>Negro, brillo</b>	9 3653 25 10	10	<b>18,49</b>
<b>Cromo, mate</b>	9 3653 25 68	10	<b>40,78</b>
<b>Acero</b>	9 3653 25 24	10	<b>40,78</b>

• Enclavamiento electrónico

## Reguladores



9 2891 25 01

### Regulador 1-10 con marco

Descripción	Referencia	Emb.	Precio (€)
<b>Marrón, mate</b>	9 2891 25 01	10	<b>114,18</b>
<b>Antracita, mate</b>	9 2891 25 05	10	<b>114,18</b>
<b>Gris, brillo</b>	9 2891 25 06	10	<b>114,18</b>
<b>Blanco polar, brillo</b>	9 2891 25 09	10	<b>114,18</b>

## Cajas de montaje en superficie



9 1151 25 09

## 1 elemento

Descripción	Referencia	Emb.	Precio (€)
<b>Marrón, mate</b>	9 1151 25 01	10	<b>10,42</b>
<b>Antracita, mate</b>	9 1151 25 05	10	<b>10,42</b>
<b>Gris brillo</b>	9 1151 25 07	10	<b>16,28</b>
<b>Blanco polar, brillo</b>	9 1151 25 09	10	<b>10,42</b>
<b>Negro, brillo</b>	9 1151 25 10	10	<b>15,97</b>



9 1151 25 19

## 1 elemento con abrazadera

Descripción	Referencia	Emb.	Precio (€)
<b>Marrón, mate</b>	9 1151 25 11	10	<b>12,20</b>
<b>Antracita, mate</b>	9 1151 25 15	10	<b>12,20</b>
<b>Gris brillo</b>	9 1151 25 17	10	<b>12,20</b>
<b>Blanco polar, brillo</b>	9 1151 25 19	10	<b>12,20</b>
<b>Negro, brillo</b>	9 1151 25 20	10	<b>15,93</b>



9 1152 25 69

## 1 elemento diseño plano

Descripción	Referencia	Emb.	Precio (€)
<b>Antracita, mate - sin abrazadera</b>	9 1152 25 25	10	<b>4,49</b>
<b>Blanco polar, brillo - sin abrazadera</b>	9 1152 25 29	10	<b>7,22</b>
<b>Antracita, mate - con abrazadera</b>	9 1152 25 55	10	<b>12,69</b>
<b>Blanco polar, brillo - con abrazadera</b>	9 1152 25 59	10	<b>12,80</b>
<b>Antracita, mate - con 2 abrazaderas</b>	9 1152 25 65	10	<b>6,27</b>
<b>Blanco polar, brillo - con 2 abrazaderas</b>	9 1152 25 69	10	<b>16,40</b>

## Cajas de empotrar



9 1820 01

## Gris con entrada de cable

Descripción	Referencia	Emb.	Precio (€)
<b>Estrecha, Ø 45mm, 22 mm prof.</b>	9 1820 01*	200	<b>2,55</b>
<b>Ø 45mm, 35'5 mm profundidad</b>	9 1820 **	200	<b>2,74</b>

\* Sólo para interruptores y pulsadores  
 \*\* Para interruptores y tomas de corriente



9 1887

## Gris con doble entrada de cable interna

Descripción	Referencia	Emb.	Precio (€)
<b>Ø49 mm, 38 mm profundidad</b>	9 1887	200	<b>3,21</b>

- 2 entradas de cable



9 1883

## Gris con entrada de cable

Descripción	Referencia	Emb.	Precio (€)
<b>Ø49 mm, 45'5 mm profundidad</b>	9 1883	200	<b>3,06</b>

- 2 entradas de cable en la parte trasera



9 1915 01

## Caja empotrar doble

Descripción	Referencia	Emb.	Precio (€)
<b>Gris, con entrada de cable</b>	9 1915 01	10	<b>9,76</b>
<b>Gris, con 2 entradas de cable</b>	9 1915 02	10	<b>4,49</b>

- 49 mm ancho, 37 mm profundo, 109 mm alto
- 2 entradas de cable



9 1933

## Caja empotrar triple

Descripción	Referencia	Emb.	Precio (€)
<b>Gris, con entrada de cable</b>	9 1933	10	<b>6,41</b>

- 49 mm ancho, 38 mm profundo, 168 mm alto
- con 6 entradas de cable, 1 a cada lado, arriba, abajo y 2 en la parte trasera



8 1837

## Caja empotrar con abrazadera

Descripción	Referencia	Emb.	Precio (€)
<b>Ø 58 mm, 35 mm de profundidad</b>	8 1837	200	<b>3,06</b>

## Accesorios



9 1825 25 12

## Anillo superficie

Descripción	Referencia	Emb.	Precio (€)
<b>Marrón, mate</b>	9 1825 25 11	10	<b>3,48</b>
<b>Antracita, mate</b>	9 1825 25 15	10	<b>3,48</b>
<b>Gris brillo</b>	9 1825 25 06	10	<b>3,48</b>
<b>Blanco polar, brillo</b>	9 1825 25 12	10	<b>3,48</b>
<b>Negro, brillo</b>	9 1825 25 10	10	<b>3,48</b>
<b>Cromo, mate</b>	9 1825 25 68	10	<b>13,54</b>
<b>Acero</b>	9 1825 25 24	10	<b>13,54</b>



1813 09

## Entrada cable

Descripción	Referencia	Emb.	Precio (€)
<b>Blanco</b>	1813	10	<b>1,57</b>
<b>Blanco polar</b>	1813 09	10	<b>2,26</b>
<b>Negro</b>	1813 05	10	<b>2,26</b>



1817 09

## Entrada tubo

Descripción	Referencia	Emb.	Precio (€)
<b>Blanco polar</b>	1817 09	10	<b>4,38</b>
<b>Negro</b>	1817 05	10	<b>4,38</b>



8 1836 02

## Anillo de fijación

Descripción	Referencia	Emb.	Precio (€)
<b>Gris, grosor 5 mm</b>	8 1836	200	<b>2,79</b>
<b>Gris oscuro, grosor 4 mm</b>	8 1836 01	200	<b>2,79</b>
<b>Blanco polar, grosor 6 mm</b>	8 1836 02	200	<b>2,24</b>



9 1844

## Plantilla de fijación

Descripción	Referencia	Emb.	Precio (€)
<b>Gris</b>	9 1844	10	<b>2,24</b>

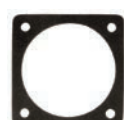

9 1853

## Sellado IP44

Descripción	Referencia	Emb.	Precio (€)
<b>Negro</b>	9 1853	10	<b>2,24</b>

## Esquema de montaje IP 44

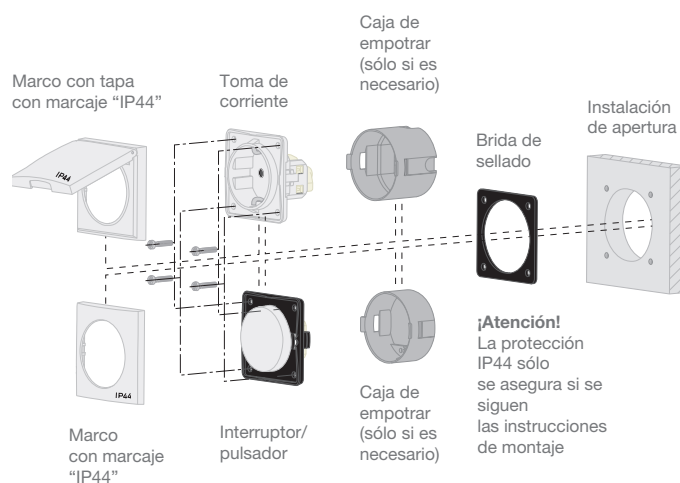

## Mecanismo IP55



# Estanco

## cubyko IP55

Su premiado y refinado diseño se adapta a todos los entornos y resiste todas las estaciones. La flexibilidad de su gama, su montaje rápido e intuitivo, su estanqueidad perfecta IP55 y su visibilidad notable gracias al anillo luminoso de LEDs, son 4 buenas razones por las que escoger cubyko.

Más información: [www.hager.es/cubyko](http://www.hager.es/cubyko)

:hager



# cubyko IP55

cubyko, la gama de mecanismos estancos, se distingue por su diseño refinado que se adapta a todos los entornos y resiste todas las estaciones. De protección IP55, puede ser opcionalmente iluminado por un LED.

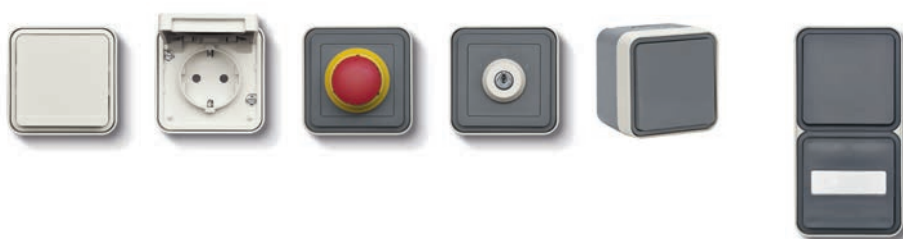

# cubyko mecanismo estanco IP55

La gama cubyko se distingue por su refinado diseño que se adapta a todos los entornos y resiste todas las estaciones. Idónea para ambientes rigurosos o de trabajo, garajes, piscinas...

Los módulos tebis KNX pueden integrarse en el espacio disponible y ofrece asimismo mecanismos con conexión

rápida, excepto las tomas Schuko donde los terminales son de tornillo.

Gama disponible en superficie y en empotrar y en los colores blanco polar y gris.



## Ventajas:

---

- Disponible en 2 colores: gris y blanco
  - Anillos luminosos para aumentar su visibilidad
  - Made in Europe
- 

## Características técnicas:

---

- Estanqueidad perfecta IP55
  - Estanqueidad del soporte de la tecla
  - Mecanismo con sistema de clipaje fácil, rápido e intuitivo
-

# Más ventajas



## 01

2 versiones:

- Componibles : flexibilidad en la gestión del stock.
  - Monobloc : una sola referencia a gestionar.
- De empotrar y de superficie.

## 02

La fijación del soporte con tornillos de 1/4 de vuelta y el fácil clipaje del mecanismo son un sistema patentado por cubyko. Máximo espacio para el cableado.

## 03

5 elementos, garantizan una óptima protección y total estanqueidad (patente cubyko).

## 04

La versión en superficie de cubyko, destaca por su gran visibilidad gracias a un anillo luminoso LED, disponible en colores blanco o azul.

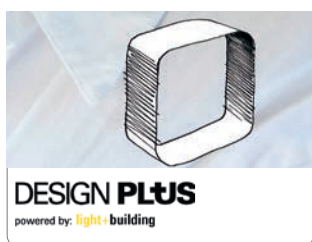







## 05

El diseño cubyko realizado por Erwin Van Handenhoven, Director de Diseño Hager Group, fue premiado en la feria Light and Building 2014.

## 06

Productos certificados VDE y AENOR.

	Monobloc superficie		Monobloc empotrar		Mecanismos componibles	
						
	gris	blanco polar	gris	blanco polar	gris	blanco polar
<b>Interruptores 10AX - 250V ~</b>						
- conmutador	WNC001	WNC001B	WNE001	WNE001B	WNA001	WNA001B
- conmutador luminoso (incluye lámpara 250V 0,4mA)	WNC002	-	-	-	WNA002	WNA002B
- conmutador con testigo (incluye lámpara 250V 0,75mA)	WNC003	-	-	-	WNA003	WNA003B
- conmutador con portaetiquetas	-	-	-	-	WNA006	WNA006B
- bipolar	-	-	-	-	WNA008	WNA008B
- cruzamiento	-	-	-	-	WNA010	WNA010B
<b>Pulsadores 10A - 250V ~</b>						
- pulsador NA	WNC020	-	-	-	WNA020	WNA020B
- pulsador NA/NC luminoso (incluye lámpara 250V 0,4mA)	WNC021	-	-	-	WNA021	WNA021B
- pulsador NA/NC	WNC022	-	-	-	WNA022	WNA022B
- pulsador NA testigo o luminoso (incluye lámpara 250V 0,75mA)	WNC023	-	WNE023	WNE023B	WNA023	WNA023B
- pulsador NA c/portaetiquetas (incluye lámpara 12-24V 0,4mA)	WNC025	-	WNE025	WNE025B	WNA025	WNA025B
<b>Mecanismos dobles 10AX - 250V ~</b>						
- doble conmutador	WNC040	-	WNE040	WNE040B	WNA040	WNA040B
- doble conmutador luminoso	WNC041	-	-	-	WNA041	WNA041B
- doble pulsador inversor NA/NC	WNC044	-	-	-	WNA044	WNA044B
- doble pulsador luminoso	-	-	-	-	WNA045	WNA045B
<b>Interruptores de llave</b>						
- 2 posiciones, con llave	WNC035	-	-	-	WNA035	-
- 3 posiciones, con llave	WNC036	-	-	-	WNA036	-
- 3 posiciones y Ø	-	-	-	-	WNA037	WNA037B
<b>Interruptor de emergencia</b>						
- con llave	WNC032	-	-	-	WNA032	-
- ¼ de vuelta	WNC033	-	-	-	WNA033	-
<b>Mecanismos persianas 10AX - 250V ~</b>						
- doble conmutador	-	-	-	-	WNA300	WNA300B
- doble pulsador	-	-	-	-	WNA301	WNA301B
<b>Salida de cable / Tapa ciega</b>						
- salida de cable	WNC155	WNC155B	WNE155	WNE155B	WNA155	WNA155B
- tapa ciega	-	-	-	-	WNA157	WNA157B
<b>Tomas SCHUKO 16A - 250V ~</b>						
- toma SCHUKO	WNC161	WNC161B	WNE161	WNE161B	WNA161	WNA161B
- toma SCHUKO doble horizontal	WNC164	-	-	-	-	-
- toma SCHUKO doble vertical	WNC174	-	-	-	-	-
- toma SCHUKO triple horizontal	WNC165	-	-	-	-	-
<b>Adaptadores</b>						
- adaptador para mecanismo 45x45	-	-	-	-	WNA450	-
- adaptador diámetro 22,5	-	-	-	-	WNA038	-
- adaptador KNX	WNC455	WNC455B	-	-	WNA455	WNA455B
<b>Pilotos 10AX - 250V ~</b>						
- verde/rojo	-	-	-	-	WNA601	-
- azul	-	-	-	-	WNA602	-
- blanco	-	-	-	-	WNA603	-

**Soportes de empotrar**

	elemento 1		elementos 2		elementos 3	
	gris	blanco polar	gris	blanco polar	gris	blanco polar
- simples - doble horizontal - doble vertical - triple horizontal	<b>WNA401</b> - - -	<b>WNA401B</b> - - -	- <b>WNA402</b> <b>WNA408</b> -	- <b>WNA402B</b> <b>WNA408B</b> -	- - - <b>WNA403</b>	- - - <b>WNA403B</b>

**Cajas de superficie**

	elemento 1		elementos 2		elementos 3	
	gris	blanco polar	gris	blanco polar	gris	blanco polar
- 1 elemento (1+2 entradas) - 1 elemento (1+1 entradas) - doble horizontal (1+2 entradas) - doble horizontal (3x1+2 entradas) - doble vertical (1+2 entradas) - triple horizontal (2x1+2 entradas)	<b>WNA681</b> <b>WNA684</b> - - - -	<b>WNA681B</b> - - - - -	- - <b>WNA682</b> <b>WNA685</b> <b>WNA686</b> -	- - <b>WNA682B</b> <b>WNA685B</b> <b>WNA686B</b> -	- - - - - <b>WNA683</b>	- - - - - <b>WNA683B</b>

**Anillo luminoso (sólo para productos en superficie)**

	simple		doble horizontal		doble vertical	
	230V	12 - 24V	230V		230V	
- azul (intensidad luminosa fuerte) - blanco (intensidad luminosa débil)	<b>WNA697</b> <b>WNA695</b>	<b>WNA698</b> <b>WNA696</b>	<b>WNA711</b> <b>WNA710</b>		<b>WNA712</b> <b>WNA699</b>	

**Accesorios cajas**

	gris	blanco polar	gris	blanco polar	gris	gris	gris	gris
- entrada para 2 cables - entrada de tubo y cable - prensaestopas M20 para entrada de cable Ø 7 a 14 - unión de cajas - 2 tubos M20 - tapa tornillos	<b>WNA690</b> - - - - -	<b>WNA690B</b> - - - - -	- <b>WNA691</b> - - - -	- <b>WNA691B</b> - - - -	- - <b>WNA693</b> - -	- - - <b>WNA694</b> -	- - - - <b>WNA700</b> -	- - - - - <b>WNA689</b>

**Lámparas**

	250V			12-24V		
	azul	rojo	blanco	azul	rojo	blanco
- para señalización 0,1 mA - para testigo 0,75 mA - cableadas, 0,4 mA - cableadas, 0,75 mA	<b>WUZ690</b> <b>WUZ696</b> <b>WUZ686</b> -	<b>WUZ695</b> <b>WUZ691</b> - <b>WUZ681</b>	<b>WUZ698</b> <b>WUZ699</b> - -	<b>WUZ692</b> - <b>WUZ682</b> -	<b>WUZ697</b> - <b>WUZ687</b> -	- - - -

## Monobloc de superficie

<b>Conmutadores 10AX - 250 V AC</b>		Referencia	Emb.	Precio (€)
	gris	WNC001	10	<b>13,35</b>
	blanco polar	WNC001B	10	<b>13,88</b>
	con indicador luminoso	WNC002	1	<b>24,39</b>
	con testigo	WNC003	1	<b>24,46</b>
	doble conmutador	WNC040	1	<b>28,17</b>
	doble conmutador luminoso	WNC041	1	<b>36,69</b>

<b>Pulsadores 10A - 250 V AC</b>		Referencia	Emb.	Precio (€)
	NA	WNC020	1	<b>16,01</b>
	inversor luminoso NA/NC	WNC021	1	<b>23,89</b>
	inversor NA/NC	WNC022	1	<b>20,00</b>
	NA testigo o luminoso	WNC023	10	<b>23,89</b>
	NA con portaetiquetas	WNC025	10	<b>27,26</b>
	doble pulsador NA/NC	WNC044	1	<b>31,02</b>

<b>Interruptores de llave 10A - 250 V AC</b>		Referencia	Emb.	Precio (€)
	2 posiciones	WNC035	1	<b>133,61</b>
	3 posiciones	WNC036	1	<b>171,56</b>

<b>Paro de emergencia</b>		Referencia	Emb.	Precio (€)
	con llave	WNC032	1	<b>126,91</b>
	1/4 de vuelta	WNC033	1	<b>96,62</b>

<b>Temporizador</b>		Referencia	Emb.	Precio (€)
	gris	WNC009	1	<b>85,51</b>
	blanco polar	WNC009B	1	<b>86,53</b>

<b>Toma SCHUKO 16A - 250 V AC</b>		Referencia	Emb.	Precio (€)
	gris	WNC161	10	<b>17,26</b>
	blanco polar	WNC161B	1	<b>18,30</b>
	doble horizontal	WNC164	5	<b>39,94</b>
	doble vertical	WNC174	5	<b>39,94</b>
	triple horizontal	WNC165	1	<b>59,90</b>

- Protección infantil
- Terminales con tornillos
- Las tomas dobles y triples están precableadas

<b>Salida de cable</b>		Referencia	Emb.	Precio (€)
	cable ø 5 a 12 mm gris	WNC155	1	<b>25,33</b>
	cable ø 5 a 12 mm blanco polar	WNC155B	1	<b>25,91</b>

<b>Adaptador KNX</b>		Referencia	Emb.	Precio (€)
	gris	WNC455	1	<b>20,70</b>
	blanco	WNC455B	1	<b>20,70</b>

## Monobloc de empotrar

<b>Conmutadores 10AX 250 V AC</b>		Referencia	Emb.	Precio (€)
	Simple, gris	WNE001	1	<b>21,56</b>
	Simple, blanco polar	WNE001B	1	<b>21,89</b>
	Doble, gris	WNE040	10	<b>32,71</b>
	Doble, blanco polar	WNE040B	1	<b>33,68</b>

<b>Pulsadores 10AX 250 V AC</b>		Referencia	Emb.	Precio (€)
	NA testigo o luminoso, gris	WNE023	1	<b>31,87</b>
	NA testigo o luminoso, blanco p.	WNE023B	1	<b>33,24</b>
	NA portaetiquetas, gris	WNE025	10	<b>38,87</b>
	NA portaetiquetas, blanco polar	WNE025B	1	<b>39,40</b>

<b>Salida de cables</b>		Referencia	Emb.	Precio (€)
	cable ø 5 a 12 mm, gris	WNE155	1	<b>38,21</b>
	cable ø 5 a 12 mm, blanco polar	WNE155B	1	<b>39,59</b>

<b>Toma SCHUKO 16A 250 V AC</b>		Referencia	Emb.	Precio (€)
	gris	WNE161	10	<b>24,82</b>
	blanco polar	WNE161B	1	<b>26,06</b>

- Protección infantil
- Terminales con tornillos

## Interruptores

Interruptores 10AX - 250V AC		Referencia	Emb.	Precio (€)
	Descripción			
	<b>Conmutador, gris</b>	WNA001	1	<b>10,00</b>
	Descripción			
	<b>Conmutador, blanco polar</b>	WNA001B	1	<b>10,85</b>
	Descripción			
	<b>Conm. c/indicador luminoso, gris</b>	WNA002	10	<b>21,68</b>
	Descripción			
	<b>Conm. c/indicador luminoso, blanco p.</b>	WNA002B	1	<b>22,23</b>
	Descripción			
	<b>Conmutador c/testigo, gris</b>	WNA003	10	<b>21,37</b>
	Descripción			
	<b>Conmutador c/testigo, blanco p.</b>	WNA003B	1	<b>22,55</b>
	Descripción			
	<b>Conmutador c/ p-etiq., gris</b>	WNA006	1	<b>22,91</b>
	Descripción			
	<b>Conmutador c/ p-etiq., blanco p.</b>	WNA006B	1	<b>23,59</b>
	Descripción			
	<b>Interruptor bipolar 0/1, gris</b>	WNA008	10	<b>21,68</b>
	Descripción			
	<b>Interruptor bipolar 0/1, blanco p.</b>	WNA008B	1	<b>22,32</b>
	Descripción			
	<b>Cruzamiento gris</b>	WNA010	1	<b>34,61</b>
	Descripción			
	<b>Cruzamiento blanco polar</b>	WNA010B	1	<b>35,67</b>

## Pulsadores

Pulsadores 10A - 250V AC		Referencia	Emb.	Precio (€)
	Descripción			
	<b>NA, gris</b>	WNA020	1	<b>13,83</b>
	Descripción			
	<b>NA, blanco polar</b>	WNA020B	1	<b>14,18</b>
	Descripción			
	<b>NA/NC luminoso, gris</b>	WNA021	1	<b>21,65</b>
	Descripción			
	<b>NA/NC luminoso, blanco polar</b>	WNA021B	1	<b>22,29</b>
	Descripción			
	<b>NA/NC, gris</b>	WNA022	10	<b>18,02</b>
	Descripción			
	<b>NA/NC, blanco polar</b>	WNA022B	1	<b>18,66</b>
	Descripción			
	<b>NA testigo o luminoso, gris</b>	WNA023	1	<b>21,65</b>
	Descripción			
	<b>NA testigo o luminoso, blanco p.</b>	WNA023B	1	<b>22,29</b>
	Descripción			
	<b>NA con portaetiquetas, gris</b>	WNA025	10	<b>28,92</b>
	Descripción			
	<b>NA con portaetiquetas, blanco p.</b>	WNA025B	1	<b>29,92</b>

## Mecanismos dobles

Mecanismos dobles 10X - 250 V AC		Referencia	Emb.	Precio (€)
	Descripción			
	<b>Conmutador, gris</b>	WNA040	1	<b>25,42</b>
	<b>Conmutador, blanco polar</b>	WNA040B	1	<b>26,41</b>
	Descripción			
	<b>Conmutador c/ind. luminoso, gris</b>	WNA041	1	<b>38,55</b>
	Descripción			
	<b>Conmutador c/ind. luminoso, blanco p.</b>	WNA041B	1	<b>40,53</b>
	Descripción			
	<b>Pulsador inversor, NA/NC, gris</b>	WNA044	1	<b>26,56</b>
	Descripción			
	<b>Pulsador inversor, NA/NC, blanco p.</b>	WNA044B	1	<b>27,46</b>
	Descripción			
	<b>Pulsador c/ ind. luminoso, gris</b>	WNA045	1	<b>41,97</b>
	Descripción			
	<b>Pulsador c/ ind. luminoso, blanco p.</b>	WNA045B	1	<b>43,45</b>

## Mecanismos persianas

	Descripción	Referencia	Emb.	Precio (€)
	<b>Doble conmutador, gris</b>	WNA300	10	<b>41,72</b>
	<b>Doble conmutador, blanco polar</b>	WNA300B	1	<b>42,96</b>
	<b>Pulsador doble, gris</b>	WNA301	10	<b>39,09</b>
	<b>Pulsador doble, blanco polar</b>	WNA301B	1	<b>44,41</b>

## Interruptor con llave

Descripción	Referencia	Emb.	Precio (€)
<b>2 posiciones</b>	WNA035	1	<b>104,86</b>
<b>3 posiciones</b>	WNA036	1	<b>122,02</b>
<b>3 posiciones y extracción en 0, gris</b>	WNA037	1	<b>125,54</b>
<b>3 posiciones y extracción en 0, blanco polar</b>	WNA037B	1	<b>129,29</b>

## Paro emergencia

Paro emergencia 10A - 250V AC		Referencia	Emb.	Precio (€)
Descripción				
<b>Con llave</b>	WNA032	1	<b>134,26</b>	
<b>1/4 de vuelta</b>	WNA033	1	<b>109,29</b>	

• 1 NC + 1 NA

## Salida de cable

Descripción	Referencia	Emb.	Precio (€)
<b>Gris</b>	WNA155	1	<b>23,63</b>
<b>Blanco polar</b>	WNA155B	1	<b>24,37</b>

## Tapa ciega

Descripción	Referencia	Emb.	Precio (€)
<b>Gris</b>	WNA157	1	<b>19,21</b>
<b>Blanco polar</b>	WNA157B	1	<b>19,79</b>

## Temporizador

Descripción	Referencia	Emb.	Precio (€)
<b>Gris</b>	WNA009	1	<b>59,84</b>
<b>Blanco polar</b>	WNA009B	1	<b>60,91</b>

## Toma SCHUKO

Toma SCHUKO 16A - 250V AC		Referencia	Emb.	Precio (€)
Descripción				
<b>Gris</b>	WNA161	10	<b>14,77</b>	
<b>Blanco polar</b>	WNA161B	1	<b>15,20</b>	

- Protección infantil
- Terminales con tornillos

## Toma de corriente francesa

Descripción	Referencia	Emb.	Precio (€)
<b>Gris</b>	WNA100	10	<b>14,64</b>

## Señalización 10AX - 250V AC



WNA601+WS609

### Pilotos

Descripción	Referencia	Emb.	Precio (€)
<b>Verde/Rojo</b>	WNA601	1	<b>59,06</b>
<b>Azul</b>	WNA602	1	<b>59,06</b>
<b>Blanco</b>	WNA603	1	<b>59,06</b>



WNA602+WS606

### Etiquetas

Descripción	Referencia	Emb.	Precio (€)
<b>En blanco</b>	WS604*	10	<b>2,55</b>
<b>"Escaleras"</b>	WS605*	10	<b>2,55</b>
<b>"Ascensor"</b>	WS606*	10	<b>2,55</b>
<b>"WC"</b>	WS607*	10	<b>34,44</b>
<b>"Sala libre/ocupado"</b>	WS608*	10	<b>2,55</b>
<b>"Hotel"</b>	WS609*	10	<b>2,55</b>

- Mecanismos componibles disponibles en 2 versiones:
  - etiqueta en blanco, para utilización como señalización
  - etiqueta impresa, para indicar una información

Estos mecanismos incluyen un tornillo de regulación de intensidad luminosa

## Anillo luminoso



WNA695

### Intensidad luminosa débil - blanco

Descripción	Referencia	Emb.	Precio (€)
<b>230V</b>	WNA695	1	<b>48,30</b>
<b>Doble horizontal, 230V</b>	WNA710	1	<b>84,10</b>
<b>Doble vertical, 230V</b>	WNA699	1	<b>80,05</b>
<b>12-24V</b>	WNA696	1	<b>48,30</b>

### Intensidad luminosa fuerte - azul

Descripción	Referencia	Emb.	Precio (€)
<b>230V</b>	WNA697	1	<b>49,68</b>
<b>Doble horizontal, 230V</b>	WNA711	1	<b>86,45</b>
<b>Doble vertical, 230V</b>	WNA712	1	<b>86,45</b>
<b>12-24V</b>	WNA698	1	<b>49,68</b>

- Solo para instalaciones en superficie

## Garras



WK696

### Garras

Descripción	Referencia	Emb.	Precio (€)
<b>Garras</b>	WK696	50	<b>1,28</b>
<b>Garras largas</b>	WK697	50	<b>1,47</b>

## Adaptadores



WNA450

### Adaptadores

Descripción	Referencia	Emb.	Precio (€)
<b>Para referencias gallery (2 mód.)</b>	WNA450	1	<b>12,06</b>
<b>Ø diámetro 22,5 mm</b>	WNA038	1	<b>20,68</b>
<b>Adaptador KNX gris</b>	WNA455	1	<b>20,68</b>
<b>Adaptador KNX blanco polar</b>	WNA455B	1	<b>21,30</b>

## Lámparas para señalización «I»



WUZ692

Descripción	Referencia	Emb.	Precio (€)
<b>Azul 250V</b>	WUZ690	10	<b>8,86</b>
<b>Azul 12/24V</b>	WUZ692	10	<b>6,07</b>
<b>Rojo 250V</b>	WUZ695	10	<b>10,32</b>
<b>Rojo 12/24V</b>	WUZ697	10	<b>6,07</b>
<b>Blanca 250V</b>	WUZ698	10	<b>7,38</b>

- Baja intensidad luminosa
- Vida útil : 50.000h

## Lámparas para testigo «L»



WUZ691

Descripción	Referencia	Emb.	Precio (€)
<b>Rojo 250V</b>	WUZ691	10	<b>7,38</b>
<b>Azul 250V</b>	WUZ696	10	<b>9,60</b>
<b>Blanca 250V</b>	WUZ699	10	<b>7,38</b>

- Alta intensidad luminosa
- Vida útil : 50.000h

## Lámparas cableadas







WUZ686

### Lâmpadas com fios





Descripción	Referencia	Emb.	Precio (€)
<b>Azul 250V</b>	WUZ686	10	<b>6,65</b>
<b>Rojo 250V</b>	WUZ681	10	<b>6,65</b>
<b>Azul 12-24V</b>	WUZ682	10	<b>6,65</b>
<b>Rojo 12-24V</b>	WUZ687	10	<b>6,65</b>

- Vida útil : 50.000 h

## Cajas de superficie

<b>1 elemento</b>		Referencia	Emb.	Precio (€)
	Descripción			
	<b>1 (1 entrada)+ 1 (2 entradas), gris</b>	WNA681	10	<b>4,82</b>
	<b>1 (1 entrada)+ 1 (2 entradas), blanco p.</b>	WNA681B	10	<b>5,16</b>
	<b>2 (1 entrada), gris</b>	WNA684	10	<b>4,82</b>
<b>2 elementos horizontales</b>				
	Descripción	Referencia	Emb.	Precio (€)
	<b>1 (1 entrada)+ 1 (2 entradas), gris</b>	WNA682	5	<b>17,76</b>
	<b>1 (1 entrada)+ 1 (2 entradas), blanco p.</b>	WNA682B	5	<b>19,13</b>
	<b>4 entradas. 3 (1) + 1 (2), gris</b>	WNA685	5	<b>17,76</b>
	<b>4 entradas. 3 (1) + 1 (2), blanco p.</b>	WNA685B	5	<b>19,13</b>
<b>2 elementos verticales</b>				
	Descripción	Referencia	Emb.	Precio (€)
	<b>1 (1 entrada)+ 1 (2 entradas), gris</b>	WNA686	5	<b>17,76</b>
	<b>1 (1 entrada)+ 1 (2 entradas), blanco p.</b>	WNA686B	5	<b>19,13</b>
<b>3 elementos horizontales</b>				
	Descripción	Referencia	Emb.	Precio (€)
	<b>2 (1 entrada)+ 1 (2 entradas), gris</b>	WNA683	1	<b>27,32</b>
	<b>2 (1 entrada)+ 1 (2 entradas), blanco p.</b>	WNA683B	1	<b>28,15</b>

## Soportes de empotrar

<b>1 elemento</b>		Referencia	Emb.	Precio (€)
	Descripción			
	<b>Gris</b>	WNA401	10	<b>11,67</b>
	<b>Blanco polar</b>	WNA401B	10	<b>11,94</b>
<b>2 elementos horizontal</b>				
	Descripción	Referencia	Emb.	Precio (€)
	<b>Gris</b>	WNA402	5	<b>16,59</b>
	<b>Blanco polar</b>	WNA402B	5	<b>16,44</b>
<b>2 elementos vertical</b>				
	Descripción	Referencia	Emb.	Precio (€)
	<b>Gris</b>	WNA408	5	<b>16,59</b>
	<b>Blanco polar</b>	WNA408B	5	<b>16,44</b>
<b>3 elementos horizontal</b>				
	Descripción	Referencia	Emb.	Precio (€)
	<b>Gris</b>	WNA403	1	<b>27,76</b>
	<b>Blanco polar</b>	WNA403B	1	<b>28,42</b>

## Accesorios para cajas

<b>Membrana entrada para 2 cables</b>		Referencia	Emb.	Precio (€)
	Descripción			
	<b>Gris</b>	WNA690	10	<b>2,31</b>
	<b>Blanco polar</b>	WNA690B	10	<b>2,40</b>
<b>Membrana entrada para tubo y cable</b>				
	Descripción	Referencia	Emb.	Precio (€)
	<b>Gris</b>	WNA691	10	<b>1,46</b>
	<b>Blanco polar</b>	WNA691B	10	<b>1,56</b>
<b>Prensaestopa M20</b>				
	Descripción	Referencia	Emb.	Precio (€)
	<b>Para entrada cable Ø 7 a 14, gris</b>	WNA693	10	<b>11,83</b>
<b>2 tubos M20</b>				
	Descripción	Referencia	Emb.	Precio (€)
	<b>2 tubos M20, gris</b>	WNA700	10	<b>14,04</b>
<b>Accesorios</b>				
	Descripción	Referencia	Emb.	Precio (€)
	<b>Conector cajas en vertical</b>	WNA694	10	<b>3,11</b>
	Descripción	Referencia	Emb.	Precio (€)
	<b>Tapa tornillos</b>	WNA689	5	<b>1,46</b>

## Mecanismos



WNT332

### Pulsadores

Descripción	Referencia	Emb.	Precio (€)
<b>1 fase, 1 pulsador</b>	WNT331	1	<b>113,20</b>
<b>2 fases, 2 pulsadores</b>	WNT332	1	<b>128,69</b>
<b>1 fase, 2 pulsadores</b>	WNT302	1	<b>107,46</b>
<b>2 fases, 4 pulsadores</b>	WNT304	1	<b>114,21</b>

## Teclas dobles



WNT944

### Teclas

Descripción	Referencia	Emb.	Precio (€)
<b>Gris</b>	WNT944	10	<b>9,10</b>
<b>Blanco polar</b>	WNT944B	10	<b>10,98</b>
<b>C/ indicador luminoso, gris</b>	WNT954	10	<b>18,57</b>
<b>C/ indicador luminoso, blanco polar</b>	WNT954B	10	<b>18,74</b>
<b>C/ portaetiquetas, gris</b>	WNT964	10	<b>8,84</b>
<b>C/ portaetiquetas, blanco polar</b>	WNT964B	10	<b>9,53</b>
<b>C/ I y 0, gris</b>	WNT974	10	<b>8,84</b>
<b>C/ I y 0, blanco polar</b>	WNT974B	10	<b>9,53</b>
<b>C/ flechas, gris</b>	WNT982	10	<b>8,84</b>
<b>C/ flechas, blanco polar</b>	WNT982B	10	<b>9,53</b>

## Teclas simples



WNT912B

### Teclas

Descripción	Referencia	Emb.	Precio (€)
<b>Gris</b>	WNT902	10	<b>6,34</b>
<b>Blanco polar</b>	WNT902B	10	<b>6,97</b>
<b>C/ indicador luminoso, gris</b>	WNT912	10	<b>7,60</b>
<b>C/ indicador luminoso, blanco polar</b>	WNT912B	10	<b>8,22</b>
<b>C/ portaetiquetas, gris</b>	WNT922	10	<b>13,35</b>
<b>C/ portaetiquetas, blanco polar</b>	WNT922B	10	<b>13,40</b>
<b>C/ I y 0, gris</b>	WNT932	10	<b>7,60</b>
<b>C/ I y 0, blanco polar</b>	WNT932B	10	<b>8,22</b>
<b>C/ flechas, gris</b>	WNT942	10	<b>7,60</b>
<b>C/ flechas, blanco polar</b>	WNT942B	10	<b>8,22</b>

WNT922

**Descripción** cubyko tebis le seducirá gracias a su fácil instalación, su estanqueidad a toda prueba y su ingeniosa ergonomía.

- estanqueidad IP55
- sistema de fijación con 2 tornillos de ¼ de vuelta
- mecanismos con pilotos LEDs (según embellecedor)
- componible

## e easy - ETS

Funciones de entrada	Prioridad: modo manual - alarma - forzado - función de base	Modo de configuración
ON / OFF	Enciende o apaga un circuito de iluminación	<b>e</b> / ETS
Telerruptor	Gestiona un circuito de iluminación a partir de varios pulsadores. Cada pulsación invierte el estado anterior	<b>e</b> / ETS
Minutero	Enciende un circuito de iluminación durante una duración definida. Un aviso de extinción parametrizable señala el fin de la temporización por una inversión del estado de la salida durante 1s	<b>e</b> / ETS
Dimmer 1 tecla / 2 teclas	Aumenta o disminuye progresivamente la intensidad luminosa gracias a 1 o 2 teclas	<b>e</b> / ETS
Persianas / Persianas 1 tecla	Permite subir o bajar una persiana y/o las lamas de un estor de lamas gracias a 1 pulsador (la función Persianas con láminas necesita obligatoriamente 2 teclas para la inclinación de las lamas)	- / ETS
Persianas / Persianas 2 teclas	Permite subir o bajar una persiana o las lamas de un estor a lamas gracias a 2 teclas	<b>e</b> / ETS

Funciones de entrada	WNTxxx
ON / OFF	<b>e</b> / ETS
Telerruptor	<b>e</b> / ETS
Minutero	<b>e</b> / ETS
Dimmer 1 tecla / 2 teclas	<b>e</b> / ETS
Persianas / Estores 2 teclas	<b>e</b> / ETS
Persianas / Estores 1 tecla	- / ETS

Series de mecanismos



# cubbyko IP55

No lo dudes: cubbyko IP55 es siempre una apuesta segura. Con su refinado y premiado diseño, es tu referente para las obras en exterior; piscinas, jardines... o para garajes y trasteros. Robusto y estanco, sus grandes ventajas te simplificarán la vida mientras lo instalas. Escoge la versión que necesites; componible o monobloc, de superficie o empotrar, en color blanco o gris.

[hager.com/es](http://hager.com/es)

Más sobre  
cubbyko:



**:hager**

# Guía técnica

# Guía técnica

pág.

---

instrucciones de limpieza y cuidado	198
lumina soul y lumina intense	200
estancas IP44	206
medidas series berker	207
cubyko IP55	212
certificados de productos y símbolos	216
materiales y colores RAL	217

---

# Instrucciones de limpieza y cuidado

Para la limpieza de las superficies utilizar un paño húmedo, suave, sin hilos.

En caso de mucha suciedad recomendamos el uso de un agente limpiador doméstico diluido que contenga jabón. Las superficies de cristal y aluminio pueden limpiarse con limpiadores comunes de cristal.

Si hay mucha suciedad en superficies de acero, es preferible utilizar limpiadores específicos. Por favor, tenga en cuenta las instrucciones de uso ya que pueden ser productos no aptos para las partes plásticas.

Los detergentes abrasivos y abrillantadores con base ácida y los detergentes que contienen cloro dañan normalmente todas las superficies. Las superficies pintadas/lacadas no deben ponerse en contacto con detergentes que contengan alcohol.



# lumina soul

## Información técnica

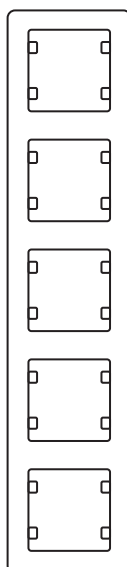
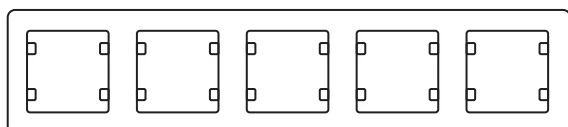
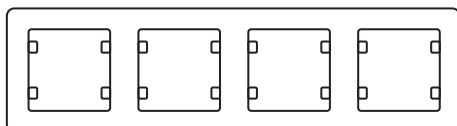
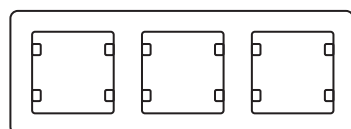
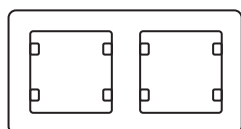
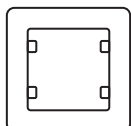

### Dimensiones

#### Marco 1 elemento

A 80 mm x H 80 mm

#### Marcos de 2 a 5 elementos, horizontal

A 151 mm x H 80 mm, 2-elementos

A 222 mm x H 80 mm, 3-elementos

A 293 mm x H 80 mm, 4-elementos

A 364 mm x H 80 mm, 5-elementos

#### Marcos de 2 a 5 elementos, vertical

H 151 mm x A 80 mm, 2-elementos

H 222 mm x A 80 mm, 3-elementos

H 293 mm x A 80 mm, 4-elementos

H 364 mm x A 80 mm, 5-elementos





## Marcos

### Plástico, brillo

blanco polar    color similar al RAL 9016

## Tapas / Tapas centrales

### Plástico, brillo

blanco polar    color similar a RAL 9016  
plata            color similar a RAL 9006  
negro            color similar a RAL 9004

# lumina intense

## Información técnica

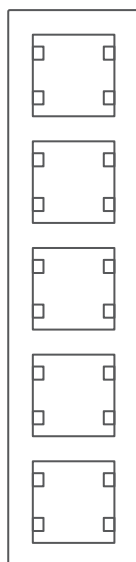
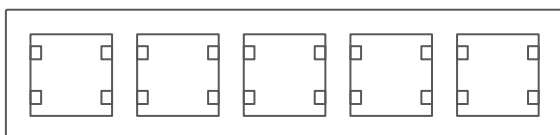
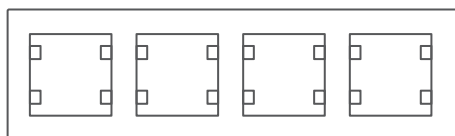
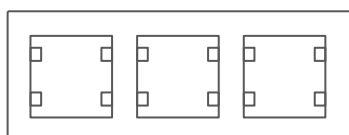
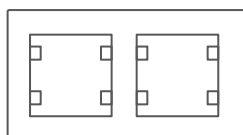
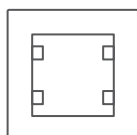

### Dimensiones

#### Marco 1 elemento

W 87,4 mm x H 87,4 mm

#### Marcos de 2 a 5 elementos, horizontal

W 158,5 mm x H 87,4 mm, 2-elementos

W 229,8 mm x H 87,4 mm, 3-elementos

W 300,4 mm x H 87,4 mm, 4-elementos

W 371,4 mm x H 87,4 mm, 5-elementos

#### Marcos de 2 a 5 elementos, vertical

H 158,5 mm x W 87,4 mm, 2-elementos

H 229,8 mm x W 87,4 mm, 3-elementos

H 300,4 mm x W 87,4 mm, 4-elementos

H 371,4 mm x W 87,4 mm, 5-elementos





## Marcos

### Plástico, brillo

blanco polar color similar al RAL 9016

### Plástico, mate

plata color similar al RAL 9006  
negro color similar al RAL 9004

## Tapas / Tapas centrales

### Plástico, brillo

blanco polar color similar al RAL 9016

### Plástico, mate

plata color similar al RAL 9006  
negro color similar al RAL 9004



**WL001X**  
Interrupor

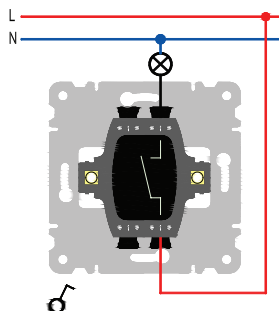

**WL002X**  
Conmutador

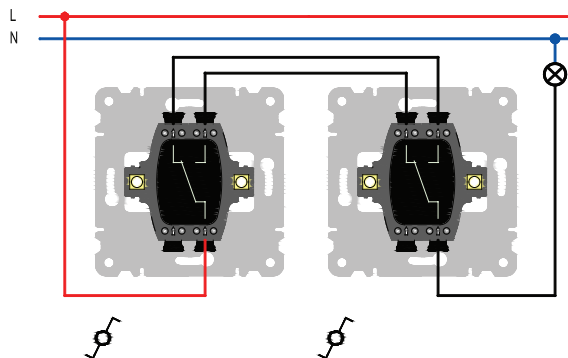

**WL022X**  
Conmutador con indicador luminoso

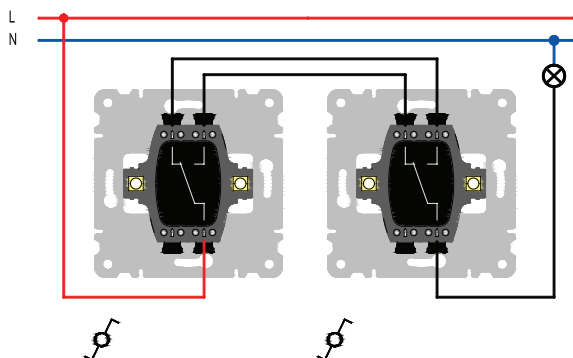

**WL004X**  
Interrupor doble

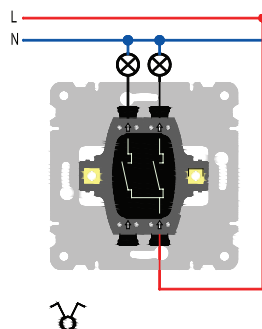

**WL024X**  
Int. doble c/ind. luminoso

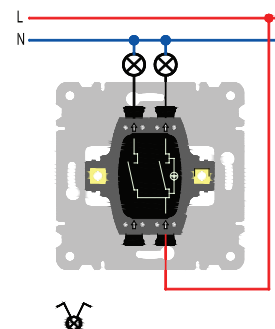

**WL003X**  
Cruzamiento

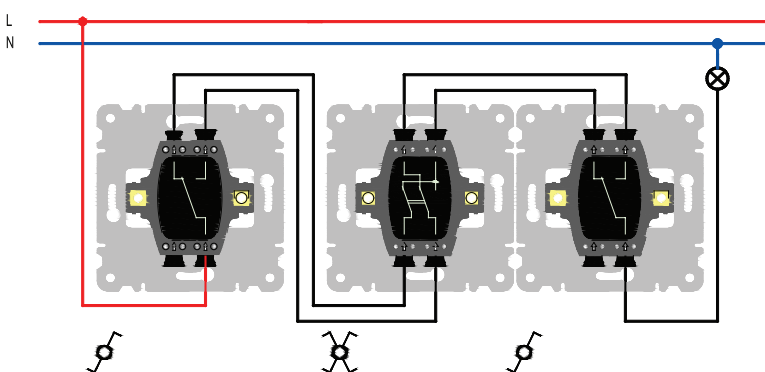

**WL005X**  
Conmutador doble

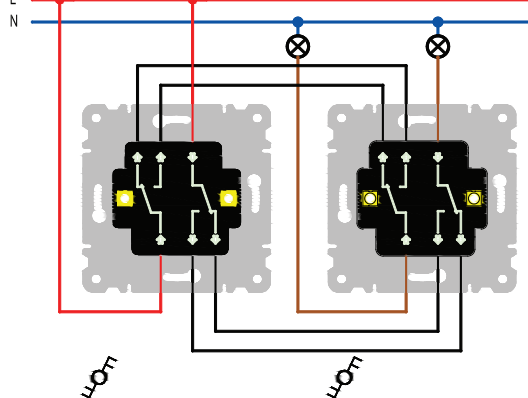

**WL041X**  
Pulsador con indicador luminoso

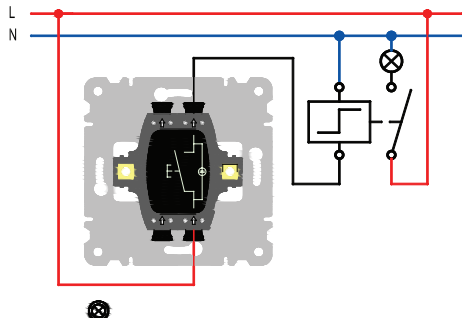

**WL051X**  
Tarjetero hotel

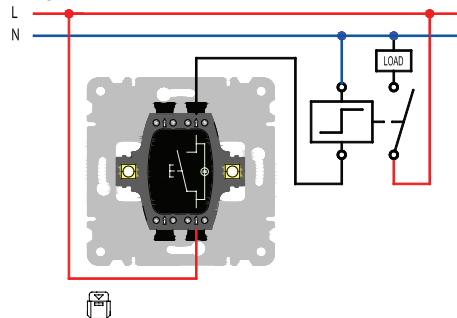

WL031X  
Interruptor persiana

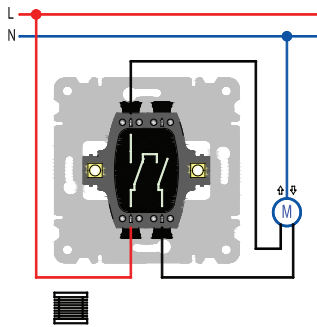

WL032X  
Pulsador persiana

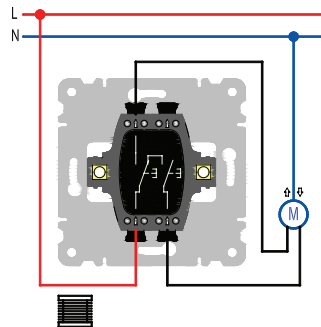

WL106X  
Toma schuko

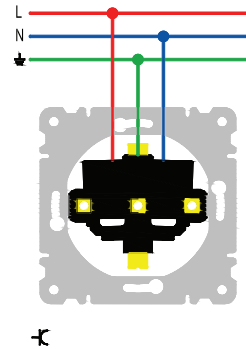

WL401X  
Regulador rotativo

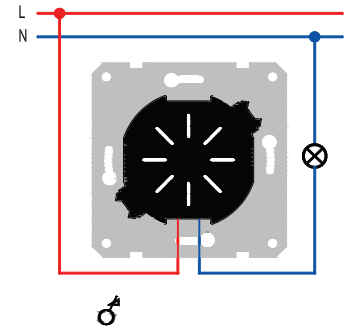

Mecanismos

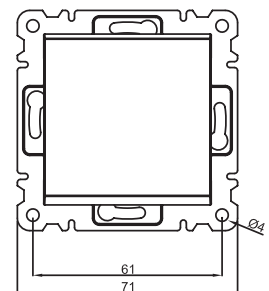
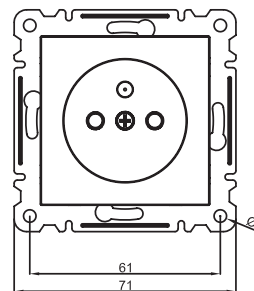
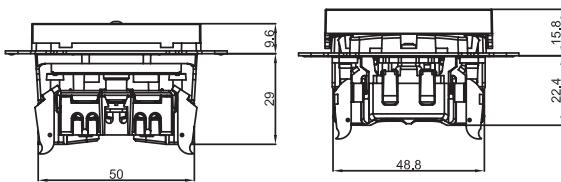

lumina soul  
Dimensiones cajas de superficie

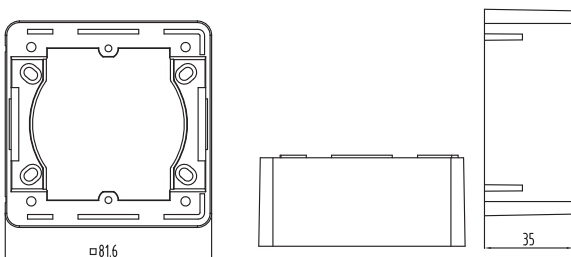

lumina intense  
Dimensiones cajas de superficie

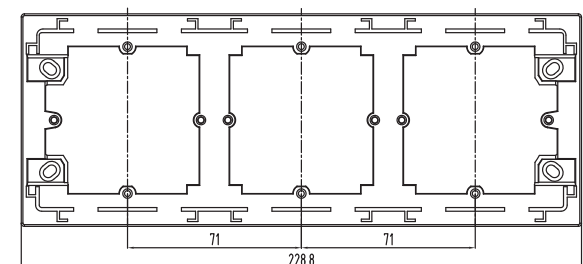
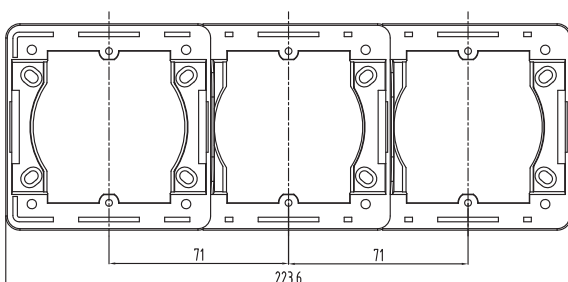
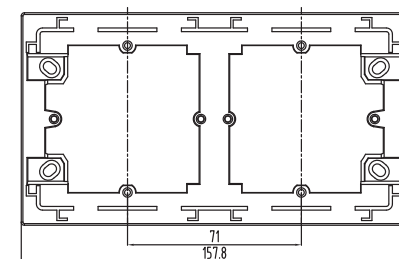
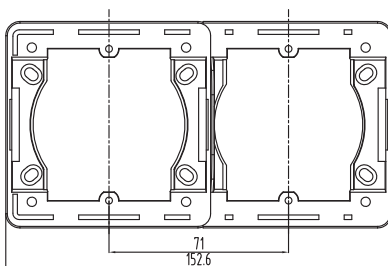
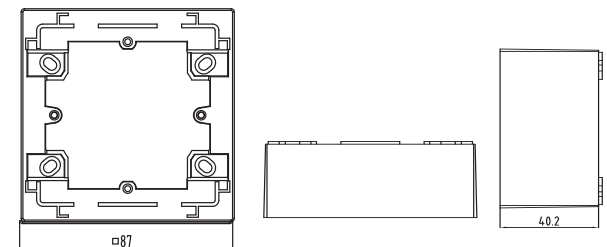

**berker Q.1/ Q.3 / K.1/ K.5 IP44**

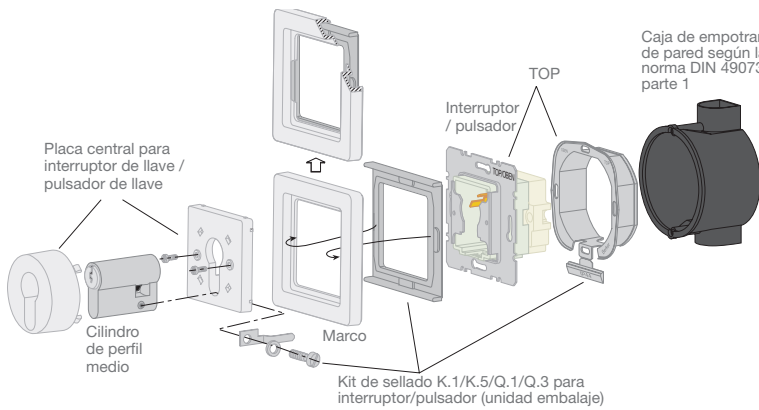
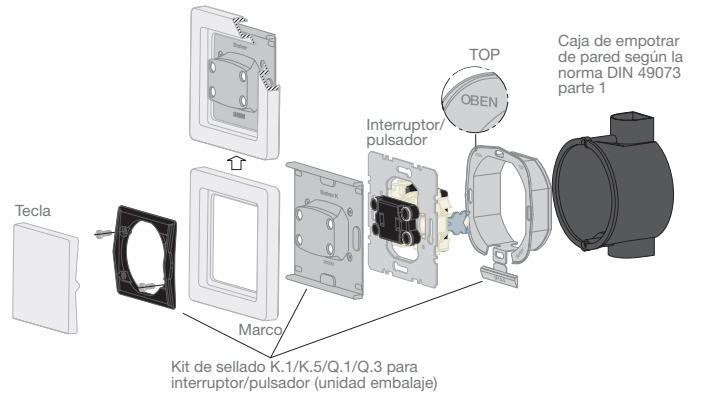
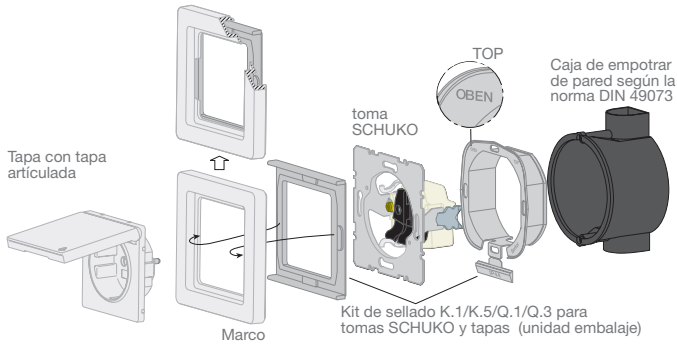

La protección IP44 es también compatible con los productos marcados con un  en este catálogo. En esta página les mostramos a que gamas pertenecen. La protección IP44 sólo puede asegurarse en estas gamas usando el kit de sellado pertinente.

**berker Q.1 / Q.3**

berker Q.1/Q.3  
pág.100 a 107



**berker K.1 / K.5**

berker K.1 / K.5  
pág. 114 a 117



**berker R.1 / R.3 IP44**

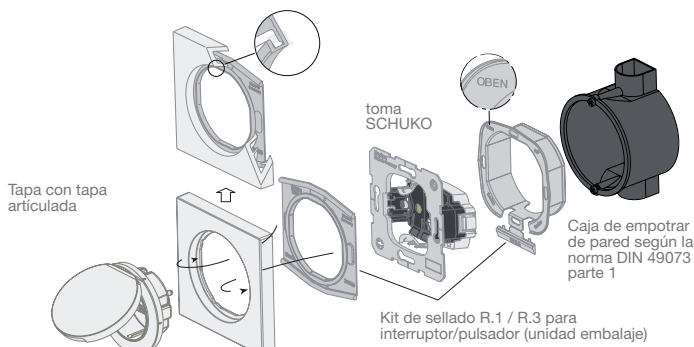

**berker R.1/R.3/R.8**

berker R.1/R.3/R.8  
pág. 138 a 144

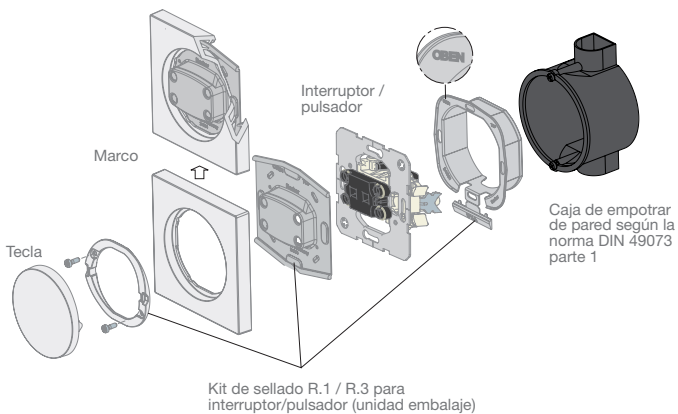

berker S.1

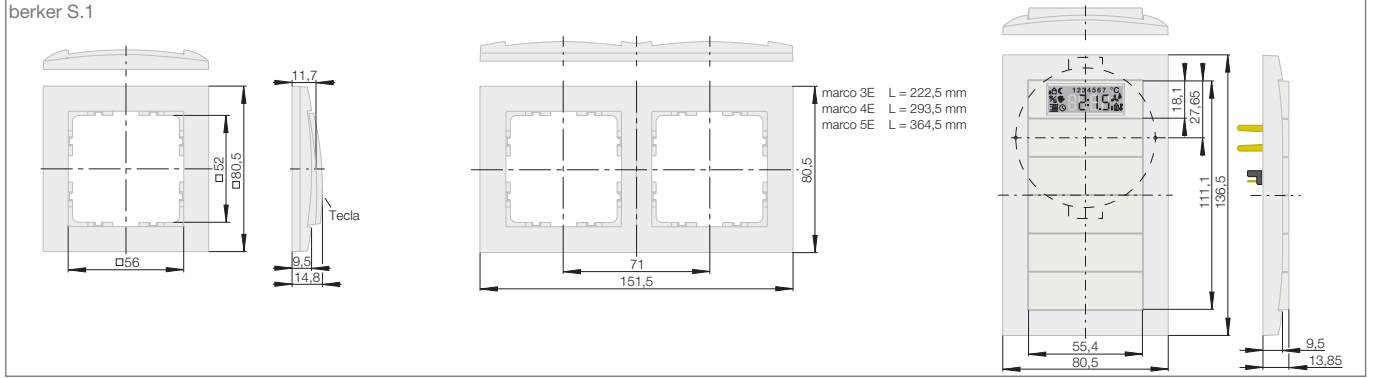

berker B.3

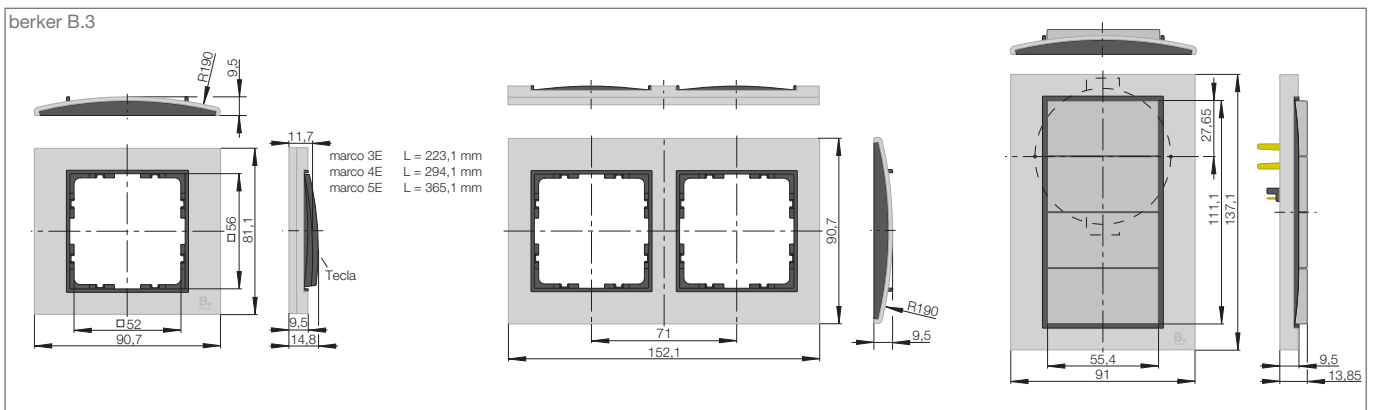

berker B.7 Glas

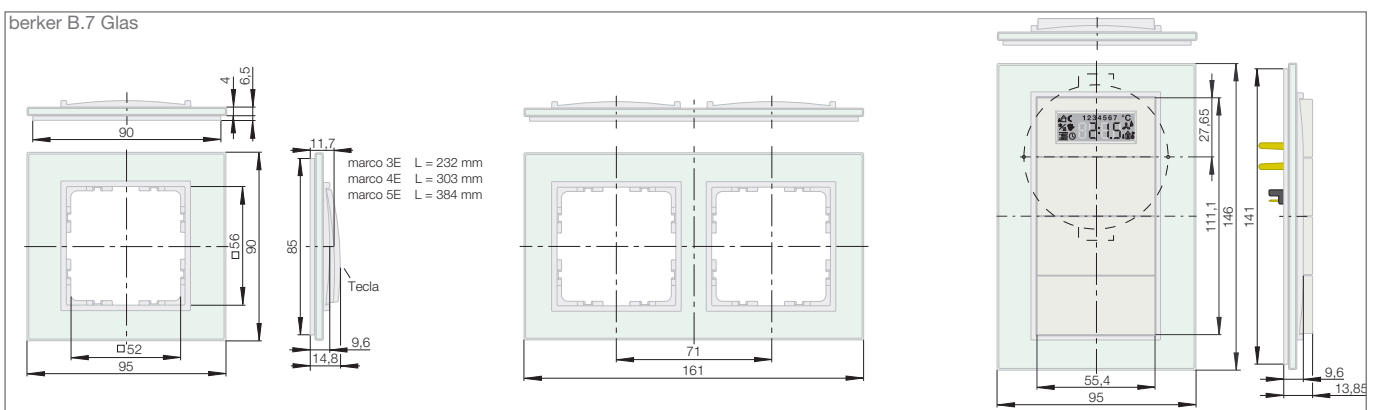

**berker Q.1**

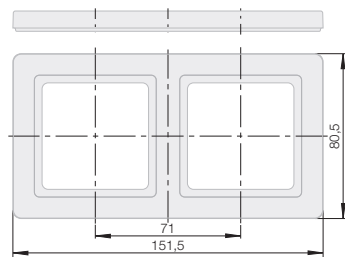
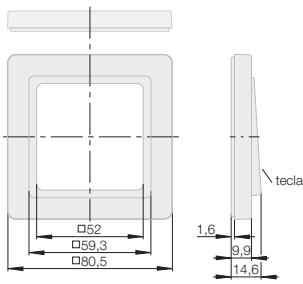

marco 3E L = 222,5 mm  
marco 4E L = 293,5 mm  
marco 5E L = 364,5 mm

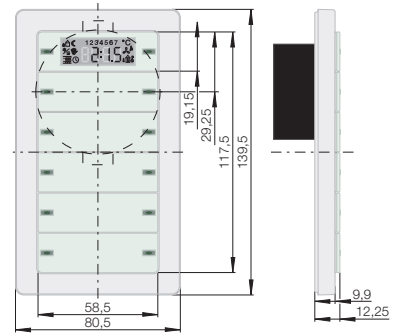

**berker Q.3**

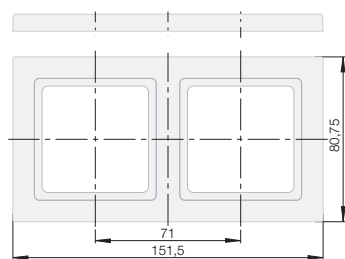
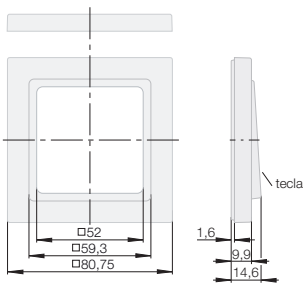

marco 3E L = 222,5 mm  
marco 4E L = 293,5 mm  
marco 5E L = 364,5 mm

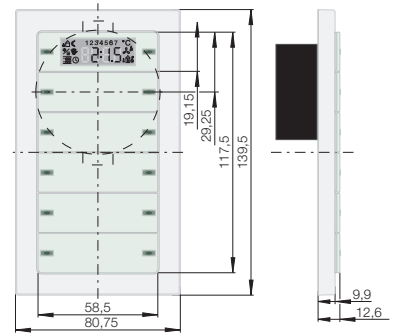

**berker K.1 / K.5**

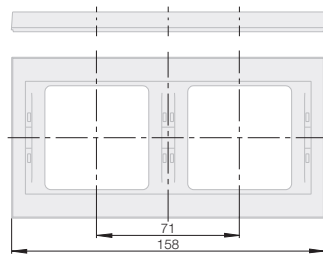
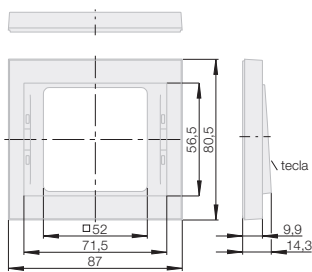

marco 3E L = 229 mm  
marco 4E L = 300 mm  
marco 5E L = 371 mm

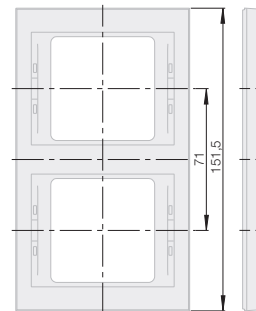

marco 3E L = 222,5 mm  
marco 4E L = 293,5 mm  
marco 5E L = 364,5 mm

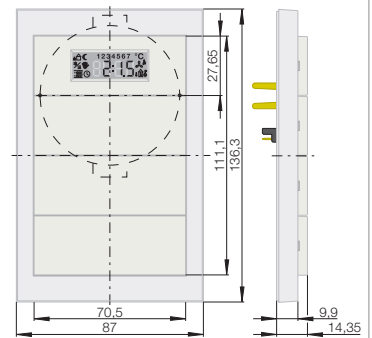

**berker R.8**

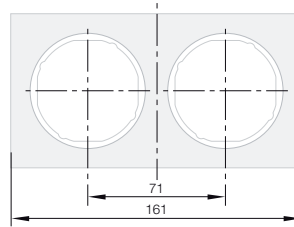
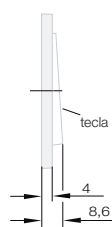
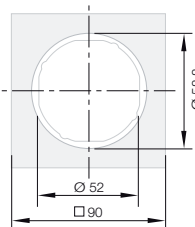

marco 3E L = 232 mm  
marco 4E L = 303 mm

berker R.1

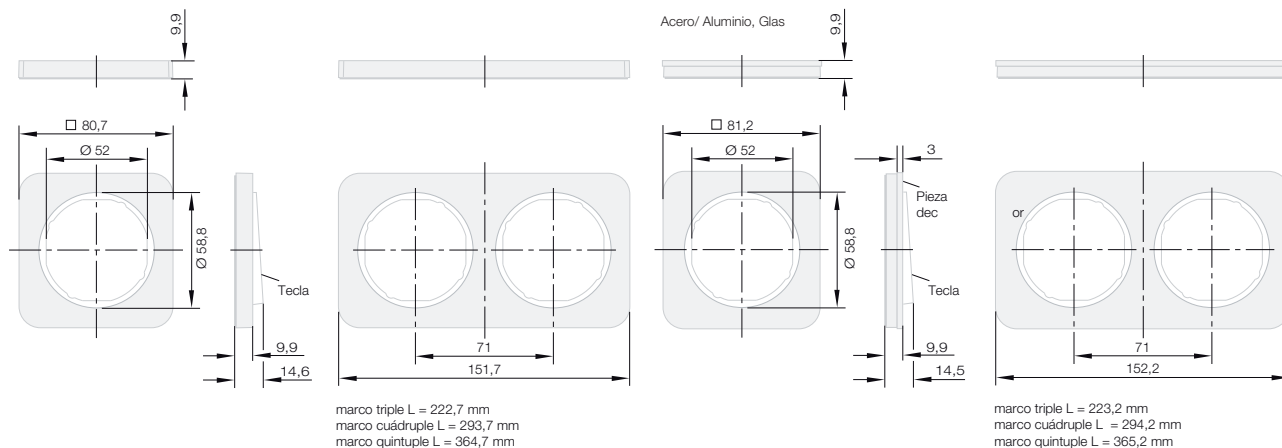

berker R.3

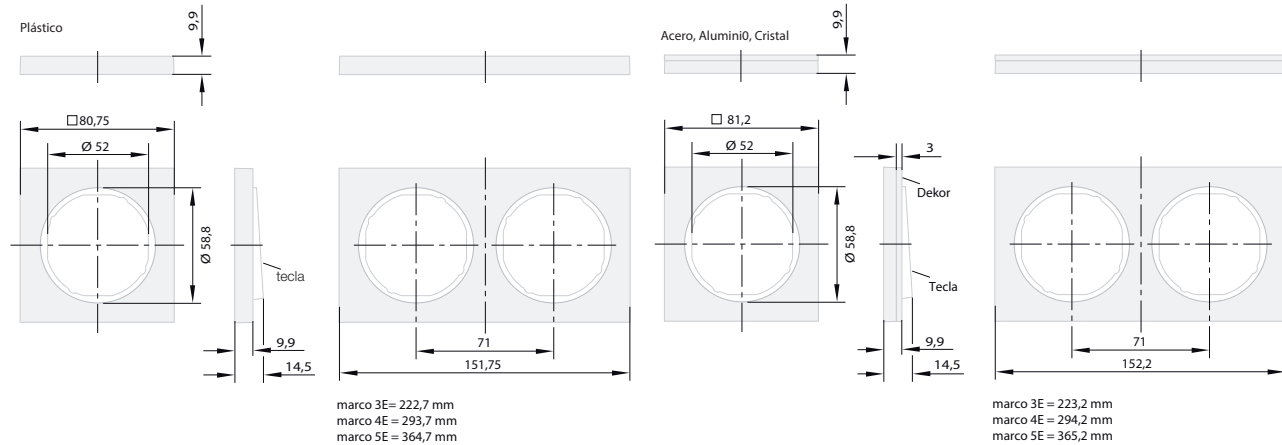

berker 1930 Porzellan Made By ROSENTHAL / Serie 1930

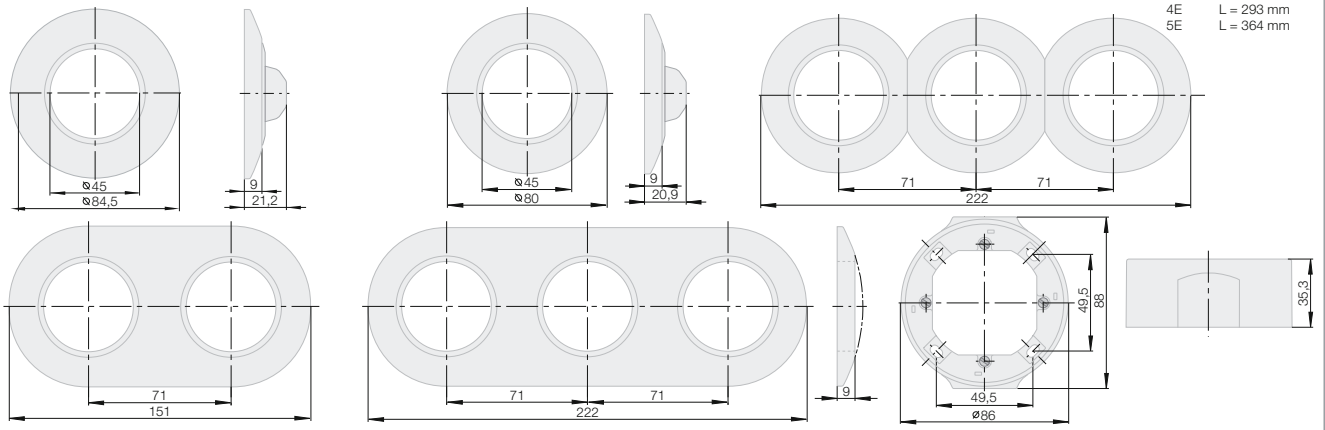

4E L = 293 mm  
5E L = 364 mm

Marco 1 elemento para tapas centrales Ø 58 mm

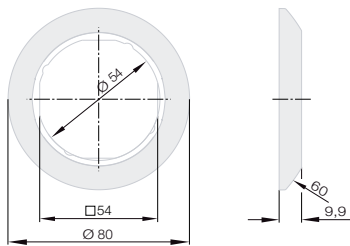

Serie Glas

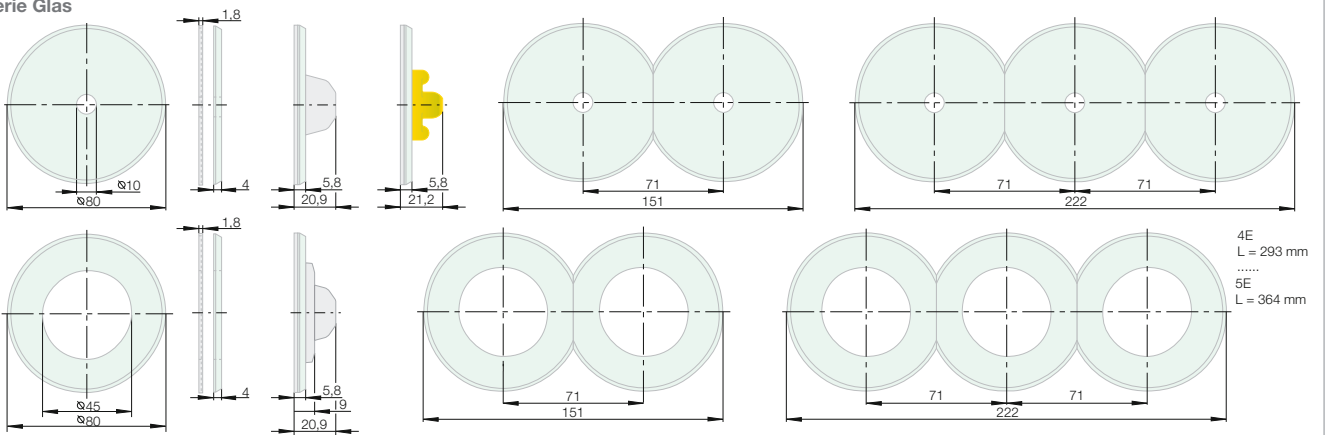

4E L = 293 mm  
.....  
5E L = 364 mm

Serie R.classic

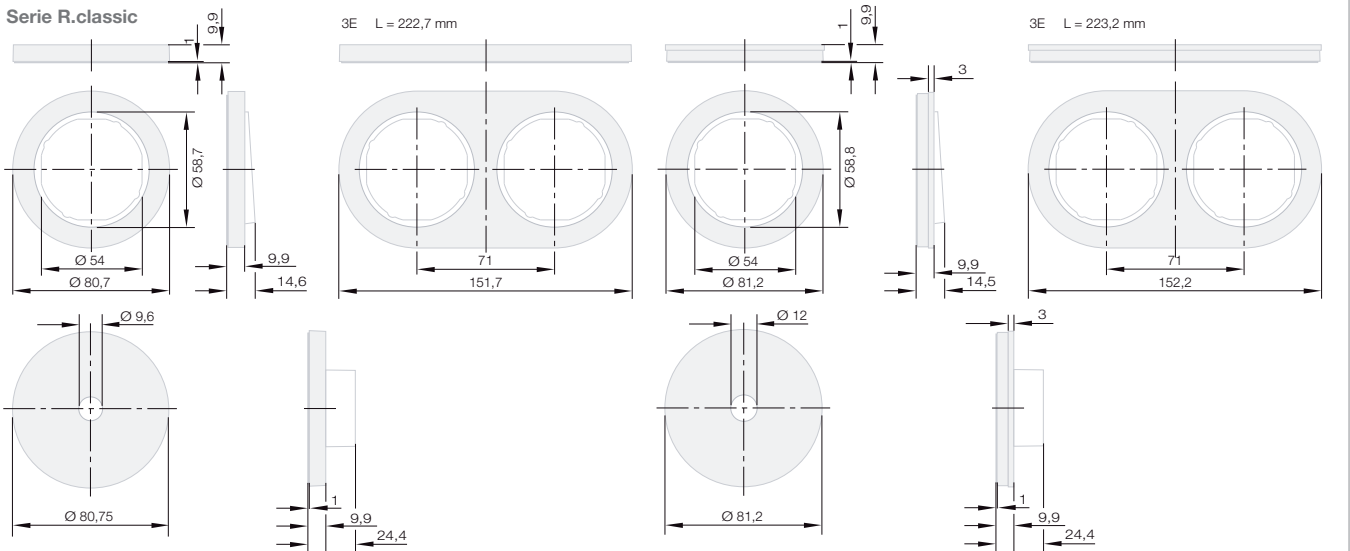

3E L = 222,7 mm

3E L = 223,2 mm



### Conexión de lámparas

WNA002, WNA002B, WNA006, WNA006B, WNA021, WNA021B,  
WNA023, WNA023B, WNA025, WNA025B, WNC002, WNC021,  
WNC023, WNE023, WNE023B

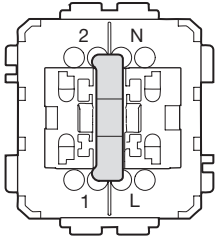

WNA003, WNA003B, WNC003

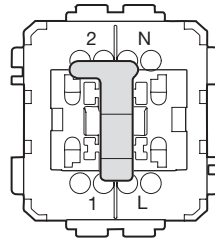

### Conexión

WNA002, WNA002B, WNA006, WNA006B,

Conmutador luminoso

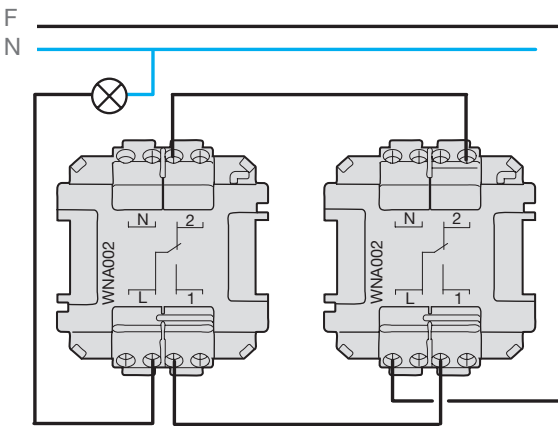

WNA003, WNA003B, WNC003

Conmutador testigo con neutro

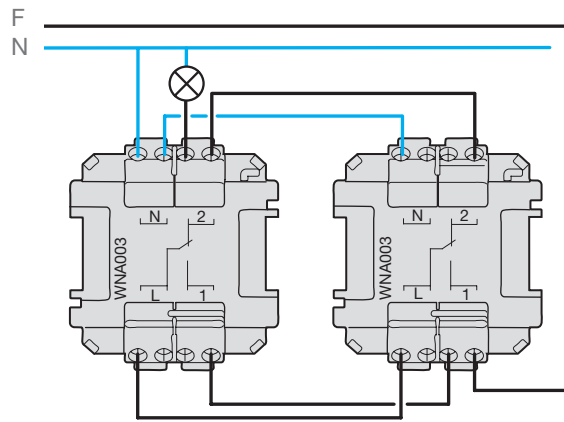

WNA001, WNA002

Conmutador testigo, cableado existente  
un único punto de gestión testigo

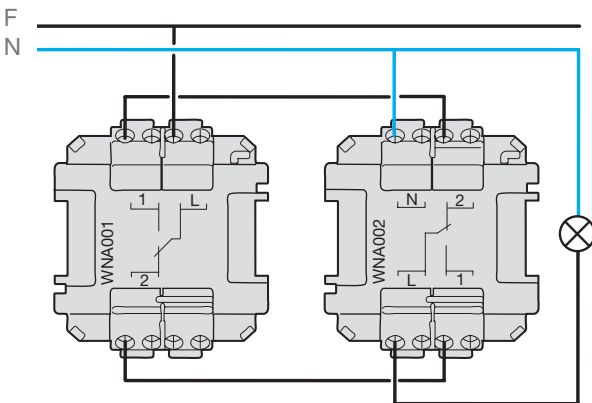

⚠ Invertir el sentido de  
montaje de la lámpara  
al conectarla entre  
L y N

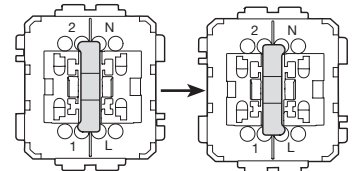

WNA695 - WNA696 - WNA697 - WNA698 - WNA699

Función señalización

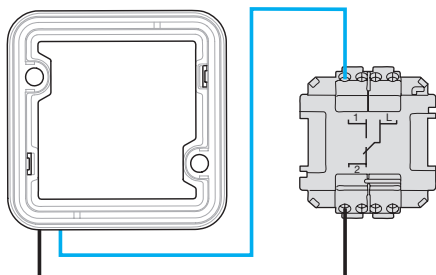

Función testigo

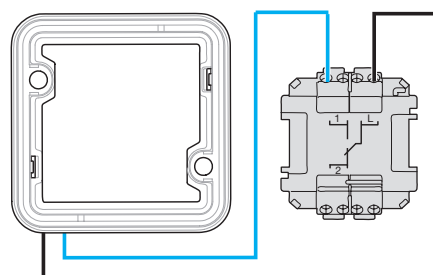

## Conexionado

### WNA002, WNA010

(Conexionado cruzamiento (función luminosa sólo sobre WNA002)

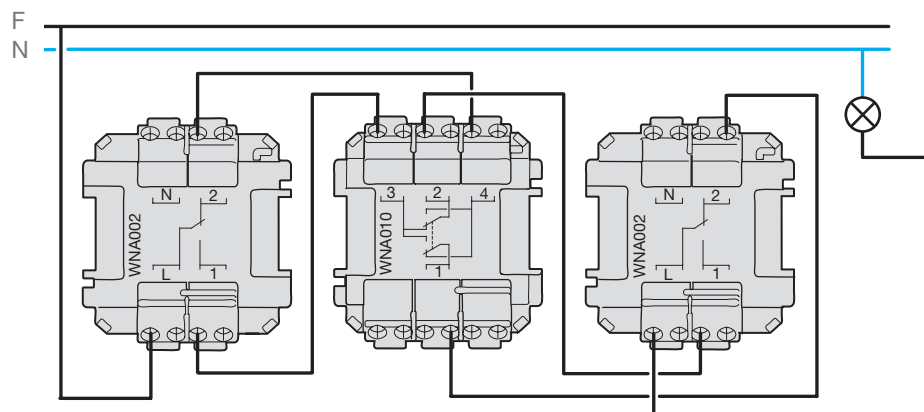

### WNA023

Pulsador testigo

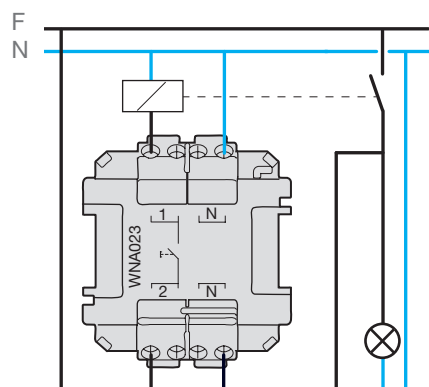

Lámpara conectada entre N/N'

### WNA023

Pulsador luminoso

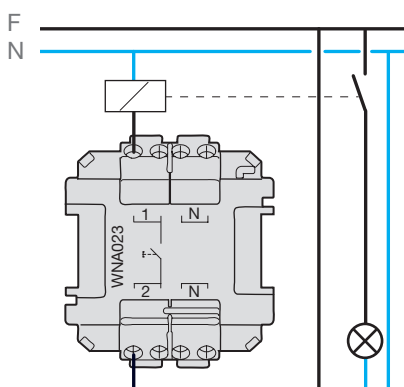

⚠ Lámpara a conectar entre 1 / 2

## Especificaciones técnicas

		Función señalización			Función testigo		
		lámpara 250V	lámpara 24V	conexión	lámpara 250V	V lámpara	conexión
<b>Conmutadores</b>							
conmutador luminoso con neutro	WNA..rX WNA..tX	WUZ690 azul WUZ695 rojo WUZ698 blanco	WUZ692 azul WUZ697 rojo	1 / 2	WUZ691 rojo WUZ696 azul WUZ699 blanco	-	N / 2
conmutador testigo con neutro	WNA..rX WNC..r	WUZ690 azul WUZ695 rojo WUZ698 blanco	WUZ692 azul WUZ697 rojo	1 / 2	WUZ691 rojo WUZ696 azul WUZ699 blanco	-	N / 2
<b>Pulsadores</b>							
inversor luminoso con neutro	WNA..r1X WNC..r1	WUZ690 azul WUZ695 rojo WUZ698 blanco	WUZ692 azul WUZ697 rojo	1 / 2	-	-	-
portaetiquetas luminoso	WNA..r0X WNC..r0 WNC..r0X	WUZ690 azul WUZ695 rojo WUZ698 blanco	WUZ692 azul WUZ697 rojo	1 / 2	-	-	-
testigo	WNA..r3X WNC..r3 WNE..r3X	WUZ690 azul WUZ695 rojo WUZ698 blanco	WUZ692 azul WUZ697 rojo	1 / 2	WUZ690 azul WUZ695 rojo WUZ698 blanco	WUZ692 azul WUZ697 rojo	N / N

Referencias en negrita: incluyen lámpara

### Caja de superficie

Precorte de condensación

Terminal wago

Agujeros precortados para sustitución

Precorte de condensación

Terminal Wago

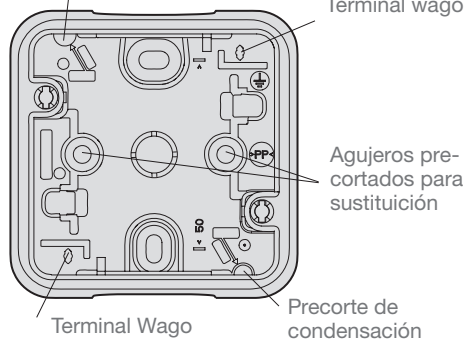

Romper el precorte con un destornillador. El agujero permite la evacuación de la condensación. El IP pasa de IP55 a IP44.

Fijación

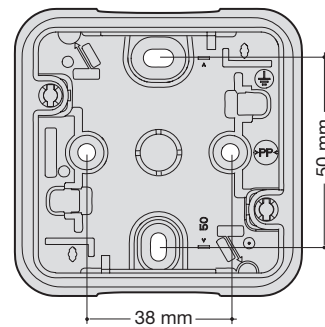

### Dimensiones

Superficie

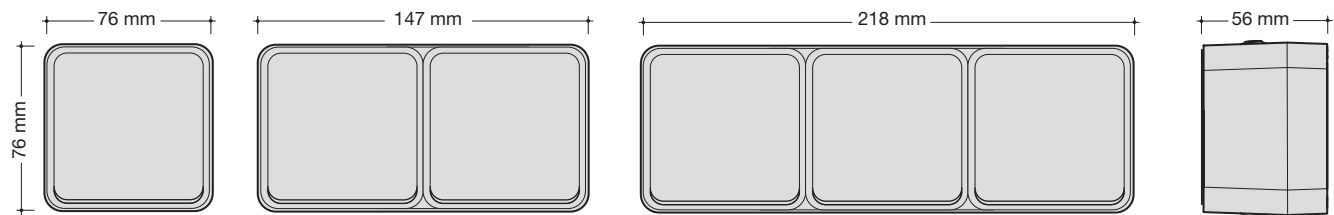

Empotrar

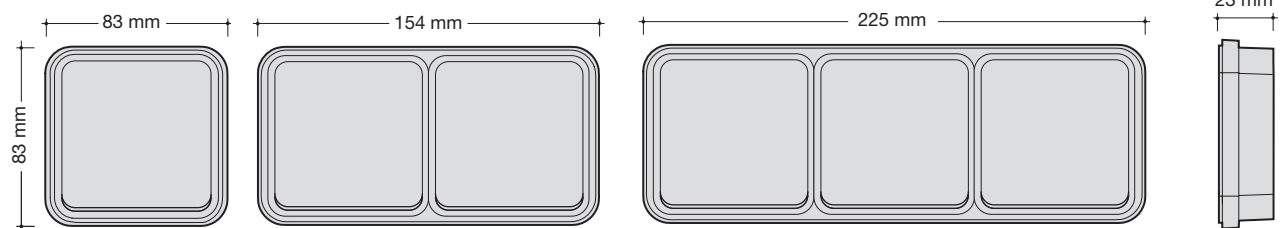

### Fijación en pladur

Empotrar

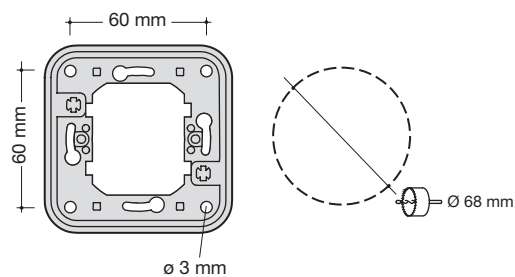

## Especificaciones técnicas

Índice de protección	IP55 e IK07
Resistencia al frío y al calor (almacenaje)	de -40 °C a +60 °C
Resistencia al frío y al calor (funcionamiento)	de -40 °C a +60 °C
Resistencia a los rayos ultravioleta	500 horas a 550 W/m <sup>2</sup>
Resistencia a niebla salina	7 días (168 h)
Resistencia a hilo incandescente	850°C, de conformidad a NF EN 60 695-2
Mantenimiento	Limpiar con un paño húmedo y agua con jabón No utilizar tricloroetileno Para cualquier otro producto, realizar una prueba previa
RAL: versión gris	Cajas soportes y cubiertas: RAL 7011 - Collarín RAL 7035
RAL: versión blanca	RAL 9010
Materiales	Polipropileno

## Resistencia a agentes químicos a 20 °C

Acetato de amilo	+
Acetato de amonio	+
Acetato de sodio	+
Acetato de etilo	+
Acetona	+
Ácido acético al 10%	+
Ácido acético al 50%	+
Ácido benzoico	+
Ácido bórico	+
Ácido bórico (solución acuosa saturada)	+
Ácido clorhídrico al 10%	+
Ácido clorhídrico al 36%	+
Ácido cítrico	+
Ácido de la batería	+
Ácido fluorhídrico al 40%	+
Ácido fórmico	+
Ácido láctico	+
Ácido nítrico al 25%	+
Ácido nítrico al 50%	-
Ácido oleico	+
Ácido oxálico	+
Ácido fosfórico	+
Ácido esteárico	+
Ácido sulfúrico al 10%	+
Ácido sulfúrico al 85%	+
Ácido tánico	+
Alcohol amílico	+
Alcohol bencílico	+
Alcohol etílico	+
Alcohol isopropílico	+
Alcohol metílico (metanol)	+
Aluminio	+
Amoniaco	+
Anhidrido acético	+
Anilina	+
Anticongelante	+
Bario	+
Benceno	-
Butiro	+
Cerveza	+
Bromuro	+
Butano	+
Cacao	+
Café	+
Carbonato de amonio	+

Carbonato de calcio	+
Cloro	-
Cloroformo	+
Cloruro de amonio	+
Cloruro de cal	+
Cera de abejas	+
Mermelada	+
Nata	+
Dentífrico	+
Detergente	+
Agua	+
Agua de cloro (líquido gaseoso)	-
Agua marina	+
Harina	+
Queso	+
Fructosa	+
Gelatina	+
Ginebra	+
Glucosa	+
Glicerina	+
Glicol	+
Alquitrán	+
Aceite alimentario	+
Aceite de motor	+
Aceite de palma	+
Aceite de oliva	+
Aceite mineral	+
Hidrógeno	+
Hipoclorito de sodio al 13%	-
Zumo de fruta	+
Keroseno	-
Leche	+
Legumbres	+
Líquido de frenos	+
Lavavajillas	+
Margarina	+
Mayonesa	+
Mercurio	+
Miel	+
Mostaza	+
Nitrato de amonio	+
Nitrato de sodio	+
Ozono	+
Parafina	+
Perfume	+
Petróleo, éter de petróleo	-

Fenol	+
Fosfato de amonio	+
Fósforo	+
Potasio	+
Propano	+
Ron	+
Jabón	+
Sal	+
Sal de aluminio	+
Sal de plata	+
Sal de carbonato	+
Sal de cloruro	+
Sal de cobre	+
Sal de magnesio	+
Sal de sulfito	+
Sal de cinc	+
Champú	+
Soda	+
Sodio	+
- Acetato de sodio	+
- Carbonato de sodio	+
- Cloruro de sodio (sal)	+
- Fosfato de sodio	+
- Sulfato de sodio	+
Azúfre	+
Azúcar	+
Sulfato de amonio	+
Trementina	-
Té	+
Tricloroetileno	-
Orina	+
Vaselina	+
Vino	+
Vinagre	+
Whisky	+
Aguarrás	+

+ : Buena resistencia

- : Inestable



Certificado VDE todos los artículos de la serie Berker para la cual este certificado es posible, llevan esta marca.



Países bajos



Austria



Noruega



Francia



Dinamarca



Italia



Suecia



Canadá



Bélgica



USA



Polonia



Finlandia



Suiza



ENEC significa Certificación Eléctrica de Normas Europeas. El número que sigue a la marca representa la entidad certificadora. Por ejemplo, VDE:10



Verificación de una mayor tensión con capacidad de soporte para la conexión de dispositivos a la norma DIN 49400 y 49441, equipos de instalación hechos con material a prueba de golpes para un mayor condicionamiento de tensión mecánica

**SV**

Fuente de alimentación de seguridad (unidad diesel VDE 0107:1994-10), designada por la placa central verde

**ZSV**

Fuente de alimentación adicional de seguridad (batería apoyado VDE 0170:1994-10), designada por la placa verde central



Muebles construcción / instalación. Los dispositivos pueden montarse en superficies con propiedades inflamables desconocidas..



Resistente a las llamas según VDE 0606 T1: 1984-1911, cumple con los requisitos de la VdS (Asociación de Aseguradores de la Propiedad) para el montaje en madera.



Todos los artículos de este catálogo que estén bajo las regulaciones de la CE llevan la marca CE en la etiqueta de embalaje y en el propio producto.

**RAL**

Determinación de graduaciones de color del Deutsches Institut für Gütesicherung und Kennzeichnung e.V. (Instituto Alemán para la Certificación y Seguridad de la Calidad)

**EDV**

Procesamiento electrónico de datos, designado para circuitos especiales por placa central roja Warenzeichen/Marken



Marca registrada de SCHUKO -Warenzeichenverband (Asociación de marca registrada SCHUKO) e.V.; designa tomas de corriente de acuerdo a DIN VDE 0620-1 y DIN 49440. Los terminales también sirven como conectores.



Marca registrada de Warenzeichenverband EDELSTAHL ROSTFREI (Asociación de marcas registradas de acero inoxidable).



Marca registrada de la Asociación KNX cvba, Bruselas



Marca registrada de PERILEX-Gemeinschaft e.V.

### Tipos / Clases de protección



Sello de supresión de radio VDE



Aislamiento protección clase 2

**IP**

(protección internacional) Designado según DIN40050, IEC60529, grado de protección de un dispositivo para prevenir el ingreso de objetos extraños y humedad

**IP44**

Protegido contra los cuerpos sólidos superiores a 1 mm de diámetro (ej. pequeños cables).  
Protegido contra las proyecciones de agua en todas direcciones

**IP55**

Protegido contra el polvo (sin sedimentos perjudiciales).  
Protegido contra los chorros de agua en todas direcciones

**IP66**

Estando al polvo.  
Protegido contra los chorros de agua similares a las olas de mar



Protección Clase III



Protección de explosiones, zona 11



IP44 – compatible, clase de protección IP44 sólo se puede obtener si se usa el kit de sellado adecuado.

### Designaciones / símbolos de aplicación



Lámpara incandescente



Lámpara fluorescente



Lámpara halógena de 12 V



Lámpara halógena de 230 V



Transformador electrónico



Transformador convencional



Caja de pared hueca



Designación para -25°C a 40°C de rango de temperatura.

**AX**

X= lámpara fluorescente – corriente nominal



Ver pág. 78



Detector de empotrar, altura de la instalación 1,1 m.



Detector de empotrar, altura de la instalación 2,5 m.



Detector, altura de la instalación 2,2 m.

**U**

Relé con microcontacto  
Diámetro de apertura

**ε**

Elemento de circuito semiconductor



Tierra

### Características del material

Los productos Berker by Hager no contienen ningún material hecho de PVC o halógeno, con la excepción de la membrana de sellado y el deslizador en la gama de superficie protegida de salpicaduras, así como las cajas de pared del sistema integrado.

Deslizador sin halógeno bajo petición

Las especificaciones técnicas que se dan aquí no son vinculantes. El manual de instrucciones suministrado con los productos se debe consultar en todos los casos.

Las ilustraciones, en especial en lo que respecta al color, tamaño, equipamiento, características de rendimiento de los productos, así como esquemas de conexiones / circuitos, no son vinculantes. Nos reservamos el derecho de realizar modificaciones técnicas y formales en nuestros productos, en virtud del avance técnico.

## Interruptores series berker

### Acabado mate

Blanco polar	RAL 9010
Antracita	RAL 7021
Antracita (B.7)	RAL 9005
Negro	RAL 9005
Rojo	RAL 3003
Marrón	RAL 8017

### Acabado brillo

Blanco	RAL 1013
Blanco polar	RAL 9010
Rojo	RAL 3003
Negro	RAL 9005
Negro (1930, Glas, Palazzo, R.Classic)	RAL 8022
Marrón	RAL 8011
Gris	RAL 7038

### Acabado lacado

Blanco polar, mate	RAL 9010
Antracita, mate	RAL 7021
Aluminio, mate (B.7)	RAL 9006
Cromo, mate (Integro)	RAL 9006
Acero (Integro)	RAL 9022

- Acabado de las tapas

### Cristal pulido, reverso impreso

Blanco polar (B.7, B.IQ, TS, TS Crystal, TS Sensor)	RAL 9010
Negro (B.7, B.IQ, TS Sensor)	RAL 9005
Aluminio (B.7, TS Sensor)	RAL 9006

### Porcelana, brillo



Blanco polar (Serie 1930 Porzellan made by Rosenthal)	RAL 9010
Negro (Serie 1930 Porzellan made by Rosenthal)	RAL 8022

### Acabados aluminio anodizado

Negro (B.3)
Marrón (B.3)
Rojo (B.3)
Dorado (B.3)

### Cristal

Blanco polar (R.1/R.3/R. Classic)	RAL 9010
Negro (R.1/R.3/R.Classic)	RAL 9005
Cristal claro (Serie Glas)	
Espejo de cristal (TS Crystal Ball)	
SWAROVSKI® ELEMENTS (TS Crystal Ball)	

### Metales\*

Aluminio anodizado E6EV1 (K.5)
Aluminio anodizado natural (R.1/R.3)
Acero inoxidable (metal cepillado)
Acero inoxidable, níquel cepillado (TS Sensor)
Latón metal galvanizado, cromo (pulsador TS, TS Crystal)
Latón metal galvanizado, Oro (24k) brillo (pulsador TS, TS Crystal)
Latón metal galvanizado, Oro (24k) brillo (pulsador TS, TS Crystal)

- Los elementos individuales que por razones técnicas no pueden ser cubiertos, se lacan.

#### Nota:

Los colores son aproximados a los RAL indicados en esta página.

# Servicios

# Servicios

pág.

---

índice de referencias	220
-----------------------	-----

---

condiciones de venta	231
----------------------	-----

---

mapa delegaciones y direcciones	233
---------------------------------	-----

---

Referencia	Precio €	Pág. tarifa	Referencia	Precio €	Pág. tarifa	Referencia	Precio €	Pág. tarifa
1001 01	29,95	155	1011 26 09	38,44	135	1012 21 89	5,16	132
1001 09	29,95	155	1011 26 14	57,62	135	1012 22 04	102,43	134
1001 20 04 00	67,56	158	1011 26 16	38,44	135	1012 22 09	68,30	134
1001 20 14 00	67,56	158	1011 26 74	57,62	135	1012 22 14	102,43	134
1001 20 45 00	20,31	158	1011 30 01	20,54	89	1012 22 16	68,30	134
1001 20 55 00	41,58	158	1011 30 04	14,31	89	1012 22 25	13,79	134
1001 20 74 00	55,27	158	1011 30 05	20,54	89	1012 22 35	13,79	134
1001 20 83 00	41,58	158	1011 30 12	20,54	89	1012 22 45	8,46	134
1001 20 84 00	55,27	158	1011 30 16	20,54	89	1012 22 69	12,60	134
1001 20 89 00	20,31	158	1011 30 21	20,54	89	1012 22 74	91,05	134
1005 70 03	19,22	123	1011 30 22	20,54	89	1012 22 79	12,60	134
1005 70 04	19,22	123	1011 30 25	20,54	89	1012 22 84	91,05	134
1005 70 06	9,88	123	1011 30 46	20,54	89	1012 22 89	5,16	134
1005 70 09	8,37	123	1011 36 06	56,66	90	1012 23 34	62,46	133
1009 14 04	17,88	94	1011 36 09	56,66	90	1012 23 39	62,46	133
1009 14 14	22,06	94	1011 39 04	14,31	89	1012 23 44	62,46	133
1009 16 06	13,97	94	1011 60 14	13,37	104	1012 23 49	62,46	133
1009 16 16	18,23	94	1011 60 16	13,37	104	1012 23 54	62,46	132
1009 19 09	10,78	94	1011 60 19	6,04	104	1012 23 59	62,46	132
1009 19 19	14,52	94	1011 60 20	54,73	106	1012 23 64	62,46	132
1009 20	34,33	164	1011 60 30	54,73	106	1012 23 69	62,46	132
1009 20 35	21,56	164	1011 60 62	2,17	104	1012 23 74	126,97	132
1009 20 45	11,31	137	1011 60 74	54,73	106	1012 23 79	126,97	132
1009 20 79	21,56	164	1011 60 76	41,97	106	1012 23 84	94,84	132
1009 20 89	10,62	137	1011 60 79	41,97	106	1012 23 89	94,24	132
1009 21	34,33	164	1011 60 83	54,73	106	1012 26 09	67,84	135
1009 60 74	17,81	110	1011 60 84	5,92	104	1012 26 14	101,78	135
1009 60 76	17,81	110	1011 60 86	5,92	104	1012 26 16	67,84	135
1009 60 79	15,23	110	1011 60 89	2,04	104	1012 26 74	101,78	135
1009 60 84	24,23	110	1011 60 94	5,92	105	1012 30 01	33,39	89
1009 60 86	24,23	110	1011 60 96	5,92	105	1012 30 04	23,26	89
1009 60 89	12,40	110	1011 60 99	3,08	105	1012 30 05	33,39	89
1009 89 12	13,10	94	1011 61 04	24,42	107	1012 30 12	33,39	89
1009 89 19	13,10	94	1011 61 06	24,42	107	1012 30 16	33,39	89
1009 89 82	10,40	94	1011 61 09	15,79	107	1012 30 21	33,39	89
1009 89 89	10,40	94	1011 61 20	68,22	107	1012 30 22	33,39	89
1010 70 00	20,55	108 , 118	1011 61 30	68,22	107	1012 30 25	33,39	89
1010 71 00	14,19	108 , 118	1011 61 74	68,22	107	1012 30 46	33,39	89
1010 72 00	8,63	108 , 118	1011 61 76	48,73	107	1012 36 06	100,02	90
1010 76 00	8,30	136	1011 61 79	48,73	107	1012 36 09	100,02	90
1010 77 00	13,08	136	1011 61 83	68,22	107	1012 39 04	23,26	89
1010 78 00	12,89	136	1011 61 84	8,42	106	1012 60 14	39,34	104
1011 20 04	55,27	154	1011 61 86	8,42	106	1012 60 16	39,34	104
1011 20 09	36,85	154	1011 61 89	6,32	106	1012 60 19	34,62	104
1011 20 14	55,27	154	1011 64 14	29,93	90	1012 60 20	96,64	106
1011 20 16	36,85	154	1011 64 24	5,94	90	1012 60 30	96,64	106
1011 20 45	6,71	154	1011 66 16	29,93	90	1012 60 62	4,21	104
1011 20 74	42,99	154	1011 66 26	7,00	90	1012 60 74	96,64	106
1011 20 84	42,99	154	1011 69 04	50,37	90	1012 60 76	74,07	106
1011 20 89	6,71	154	1011 69 09	29,93	90	1012 60 79	74,07	106
1011 21 04	58,02	132	1011 69 14	50,37	90	1012 60 83	96,64	106
1011 21 09	38,67	132	1011 69 19	4,81	90	1012 60 84	8,57	104
1011 21 14	58,02	132	1011 89 12	6,55	88	1012 60 86	8,57	104
1011 21 16	38,67	132	1011 89 19	6,55	88	1012 60 89	3,82	104
1011 21 35	9,58	133	1011 89 62	6,92	88	1012 60 94	8,57	105
1011 21 45	5,85	132	1011 89 82	1,27	88	1012 60 96	8,57	105
1011 21 74	51,58	132	1011 89 89	1,27	88	1012 60 99	3,82	105
1011 21 79	8,42	133	1011 99 09	1,41	88	1012 61 84	13,18	106
1011 21 84	51,58	132	1011 99 19	7,07	88	1012 61 86	13,18	106
1011 21 89	3,13	132	1011 99 39	2,46	88	1012 61 89	9,20	106
1011 22 04	58,02	134	1011 99 49	5,80	88	1012 64 14	55,85	90
1011 22 09	38,67	134	1011 99 59	18,82	88	1012 64 24	9,32	90
1011 22 14	58,02	134	1011 99 69	29,55	88	1012 66 16	55,85	90
1011 22 16	38,67	134	1012 20 04	134,51	154	1012 66 26	10,69	90
1011 22 35	9,58	134	1012 20 09	72,97	154	1012 69 04	88,91	90
1011 22 45	5,85	134	1012 20 14	134,51	154	1012 69 09	55,85	90
1011 22 74	51,58	134	1012 20 16	72,97	154	1012 69 14	88,91	90
1011 22 79	8,42	134	1012 20 45	18,94	154	1012 69 19	7,02	90
1011 22 84	51,58	134	1012 20 74	72,97	154	1012 89 12	11,95	88
1011 22 89	3,13	134	1012 20 84	72,97	154	1012 89 19	11,95	88
1011 23 34	35,36	133	1012 20 89	18,94	154	1012 89 62	12,33	88
1011 23 39	35,36	133	1012 21 04	102,43	132	1012 89 82	2,05	88
1011 23 44	35,36	133	1012 21 09	68,30	132	1012 89 89	2,05	88
1011 23 49	35,36	133	1012 21 14	102,43	132	1012 99 09	2,18	88
1011 23 54	35,36	132	1012 21 16	68,30	132	1012 99 19	12,20	88
1011 23 59	35,36	132	1012 21 25	13,79	133	1012 99 39	3,80	88
1011 23 64	35,36	132	1012 21 35	13,79	133	1012 99 49	8,95	88
1011 23 69	35,36	132	1012 21 45	8,46	132	1012 99 59	31,28	88
1011 23 74	70,62	132	1012 21 69	12,23	133	1012 99 69	51,01	88
1011 23 79	70,62	132	1012 21 74	91,05	132	1013 20 04	195,12	154
1011 23 84	57,93	132	1012 21 79	12,60	133	1013 20 09	105,84	154
1011 23 89	59,02	132	1012 21 84	91,05	132	1013 20 14	195,12	154

Referencia	Precio €	Pág. tarifa	Referencia	Precio €	Pág. tarifa	Referencia	Precio €	Pág. tarifa
1013 20 16	105,84	154	1013 69 14	101,84	90	1014 99 39	12,39	88
1013 20 45	28,98	154	1013 69 19	12,08	90	1014 99 49	32,12	88
1013 20 74	105,84	154	1013 89 12	18,75	88	1015 21 04	319,30	132
1013 20 84	105,84	154	1013 89 19	18,75	88	1015 21 09	167,62	132
1013 20 89	28,98	154	1013 89 62	17,72	88	1015 21 14	319,30	132
1013 21 04	171,27	132	1013 89 82	3,98	88	1015 21 16	165,43	132
1013 21 09	89,92	132	1013 89 89	3,98	88	1015 21 45	30,86	132
1013 21 14	171,27	132	1013 99 09	4,11	88	1015 21 74	193,38	132
1013 21 16	88,75	132	1013 99 19	20,29	88	1015 21 84	185,28	132
1013 21 25	22,22	133	1013 99 39	7,67	88	1015 21 89	20,89	132
1013 21 35	22,22	133	1013 99 49	16,85	88	1015 22 04	319,30	134
1013 21 45	13,61	132	1013 99 59	50,49	88	1015 22 09	167,62	134
1013 21 69	13,72	133	1013 99 69	84,84	88	1015 22 14	319,30	134
1013 21 74	103,73	132	1014 21 04	234,27	132	1015 22 16	165,43	134
1013 21 79	13,72	133	1014 21 09	122,99	132	1015 22 45	30,86	134
1013 21 84	99,38	132	1014 21 14	234,27	132	1015 22 74	193,38	134
1013 21 89	9,13	132	1014 21 16	121,40	132	1015 22 84	185,28	134
1013 22 04	171,27	134	1014 21 45	22,07	132	1015 22 89	20,89	134
1013 22 09	89,92	134	1014 21 74	141,88	132	1015 23 34	194,64	133
1013 22 14	171,27	134	1014 21 84	135,95	132	1015 23 39	194,64	133
1013 22 16	88,75	134	1014 21 89	12,75	132	1015 23 44	194,64	133
1013 22 25	22,22	134	1014 22 04	234,27	134	1015 23 49	194,64	133
1013 22 35	22,22	134	1014 22 09	122,99	134	1015 23 54	194,64	132
1013 22 45	13,61	134	1014 22 14	234,27	134	1015 23 59	194,64	132
1013 22 69	13,72	134	1014 22 16	121,40	134	1015 23 64	194,64	132
1013 22 74	103,73	134	1014 22 45	22,07	134	1015 23 69	194,64	132
1013 22 79	13,72	134	1014 22 74	141,88	134	1015 23 01	86,29	89
1013 22 84	99,38	134	1014 22 84	135,95	134	1015 30 04	60,06	89
1013 22 89	9,13	134	1014 22 89	12,75	134	1015 30 05	86,29	89
1013 23 34	104,41	133	1014 23 34	142,80	133	1015 30 12	86,29	89
1013 23 39	104,41	133	1014 23 39	142,80	133	1015 30 16	86,29	89
1013 23 44	104,41	133	1014 23 44	142,80	133	1015 30 21	86,29	89
1013 23 49	104,41	133	1014 23 49	142,80	133	1015 30 22	86,29	89
1013 23 54	104,41	132	1014 23 54	142,80	132	1015 30 25	86,29	89
1013 23 59	104,41	132	1014 23 59	142,80	132	1015 30 46	86,29	89
1013 23 64	104,41	132	1014 23 64	142,80	132	1015 36 06	239,19	90
1013 23 69	104,41	132	1014 23 69	142,80	132	1015 36 09	239,19	90
1013 23 74	183,48	132	1014 26 09	122,19	135	1015 39 04	60,06	89
1013 23 79	183,48	132	1014 26 14	232,77	135	1015 60 14	92,40	104
1013 23 84	136,64	132	1014 26 16	122,19	135	1015 60 16	92,40	104
1013 23 89	136,64	132	1014 26 74	232,77	135	1015 60 19	80,81	104
1013 26 09	89,35	135	1014 30 01	69,85	89	1015 60 62	14,56	104
1013 26 14	170,15	135	1014 30 04	48,63	89	1015 60 74	301,19	106
1013 26 16	89,35	135	1014 30 05	69,85	89	1015 60 76	230,91	106
1013 26 74	170,15	135	1014 30 12	69,85	89	1015 60 79	230,91	106
1013 30 01	46,10	89	1014 30 16	69,85	89	1015 60 83	301,19	106
1013 30 04	32,11	89	1014 30 21	69,85	89	1015 60 84	36,48	104
1013 30 05	46,10	89	1014 30 22	69,85	89	1015 60 86	36,48	104
1013 30 12	46,10	89	1014 30 25	69,85	89	1015 60 89	13,82	104
1013 30 16	46,10	89	1014 30 46	69,85	89	1015 60 94	36,48	105
1013 30 21	46,10	89	1014 36 06	228,76	90	1015 60 96	36,48	105
1013 30 22	46,10	89	1014 36 09	228,76	90	1015 60 99	13,82	105
1013 30 25	46,10	89	1014 39 04	48,63	89	1015 61 84	51,97	106
1013 30 46	46,10	89	1014 60 14	72,06	104	1015 61 86	51,97	106
1013 36 06	167,24	90	1014 60 16	72,06	104	1015 61 89	38,87	106
1013 36 09	167,24	90	1014 60 19	63,26	104	1015 64 14	162,71	90
1013 39 04	32,11	89	1014 60 62	8,96	104	1015 64 24	86,04	90
1013 60 14	54,90	104	1014 60 74	221,01	106	1015 66 16	162,71	90
1013 60 16	54,90	104	1014 60 76	169,42	106	1015 66 26	70,50	90
1013 60 19	48,10	104	1014 60 79	169,42	106	1015 69 04	184,02	90
1013 60 20	161,58	106	1014 60 83	221,01	106	1015 69 09	162,71	90
1013 60 30	161,58	106	1014 60 84	23,59	104	1015 69 14	189,83	90
1013 60 62	6,39	104	1014 60 86	23,59	104	1015 69 19	67,98	90
1013 60 74	161,58	106	1014 60 89	8,55	104	1015 89 62	38,52	88
1013 60 76	123,87	106	1014 60 94	23,59	105	1015 89 82	10,15	88
1013 60 79	123,87	106	1014 60 96	23,59	105	1015 89 89	10,15	88
1013 60 83	161,58	106	1014 60 99	8,55	105	1015 99 09	10,92	88
1013 60 84	14,84	104	1014 61 84	34,16	106	1015 99 39	13,71	88
1013 60 86	14,84	104	1014 61 86	34,16	106	1015 99 49	44,76	88
1013 60 89	6,15	104	1014 61 89	25,52	106	1019 14 04	12,59	96
1013 60 94	14,84	105	1014 64 14	123,29	90	1019 16 06	9,00	96
1013 60 96	14,84	105	1014 64 24	54,86	90	1019 19 09	5,87	96
1013 60 99	6,15	105	1014 66 16	123,29	90	1019 20 45	7,25	139 , 164
1013 61 84	21,20	106	1014 66 26	50,37	90	1019 20 89	6,71	139 , 164
1013 61 86	21,20	106	1014 69 04	135,02	90	1019 60 84	9,80	112
1013 61 89	15,88	106	1014 69 09	123,29	90	1019 60 86	9,80	112
1013 64 14	90,64	90	1014 69 14	139,27	90	1019 60 89	8,07	112
1013 64 24	49,07	90	1014 69 19	42,81	90	1019 89 82	4,84	96
1013 66 16	90,64	90	1014 89 62	27,73	88	1019 89 89	4,84	96
1013 66 26	17,56	90	1014 89 82	7,32	88	1021 12	6,27	75
1013 69 04	98,73	90	1014 89 89	7,32	88	1021 22	9,82	75
1013 69 09	90,64	90	1014 99 09	7,82	88	1021 32	17,34	75

Referencia	Precio €	Pág. tarifa	Referencia	Precio €	Pág. tarifa	Referencia	Precio €	Pág. tarifa
1022 36 06	100,02	90	1042 70 04	33,31	118	1082 89 82 00	60,11	93
1022 36 09	100,02	90	1042 70 06	30,67	118	1082 89 89 00	60,11	93
1022 60 14	39,34	104	1042 70 09	29,14	118	1083 19 09 00	92,69	93
1022 60 16	39,34	104	1042 89 35	22,32	134	1083 60 84 00	71,96	110
1022 60 19	34,62	104	1042 89 82	25,17	88	1083 60 86 00	71,96	110
1022 60 83	96,64	106	1042 89 89	25,17	88 , 134	1083 60 89 00	78,31	110
1022 60 94	34,62	105	1042 99 09	22,98	88	1083 89 82 00	60,11	93
1022 60 99	34,62	105	1042 99 39	45,78	88	1083 89 89 00	60,11	93
1022 89 12	11,95	88	1042 99 49	45,78	88	1084 14 04 00	20,43	93
1022 89 19	11,95	88	1043 16 06	39,69	89	1084 16 06 00	14,27	93
1022 99 19	13,23	88	1043 19 09	36,74	89	1084 19 09 00	12,18	93
1022 99 59	31,28	88	1043 70 03	45,98	118	1084 20 45 00	24,63	137
1022 99 69	55,30	88	1043 70 04	45,98	118	1084 20 89 00	24,13	137
1023 36 06	167,24	90	1043 70 06	48,00	118	1084 60 84 00	24,34	110
1023 36 09	167,24	90	1043 70 09	45,98	118	1084 60 86 00	24,34	110
1023 60 14	54,90	104	1043 89 35	34,95	134	1084 60 89 00	20,76	110
1023 60 16	54,90	104	1043 89 82	39,69	88	1084 89 82 00	10,49	93
1023 60 19	48,10	104	1043 89 89	39,69	88 , 134	1084 89 89 00	11,01	93
1023 60 83	161,58	106	1043 99 09	37,00	88	1087 71 03 00	19,86	120
1023 60 94	48,10	105	1043 99 39	67,16	88	1087 71 04 00	19,86	120
1023 60 99	48,10	105	1043 99 49	67,16	88	1087 71 06 00	18,87	120
1023 89 12	18,75	88	1045 70 03	19,07	121	1087 71 09 00	14,64	120
1023 89 19	18,75	88	1045 70 04	19,07	121	1088 71 03 00	19,86	120
1023 99 19	20,67	88	1045 70 06	15,00	121	1088 71 04 00	19,86	120
1023 99 59	50,49	88	1045 70 09	13,38	121	1088 71 06 00	18,87	120
1023 99 69	86,47	88	1045 71 06	17,99	121	1088 71 09 00	14,64	120
1024 36 06	228,76	90	1045 71 09	16,59	121	1090	28,83	158
1024 36 09	228,76	90	1051 60 94	6,04	105	1090 09	28,83	158
1024 60 14	72,06	104	1051 60 99	6,04	105	1091	34,46	156
1024 60 16	72,06	104	1052 60 94	34,62	105	1091 09	34,46	156
1024 60 19	63,26	104	1052 60 99	34,62	105	1092 00	40,59	156
1024 60 83	221,01	106	1052 70 03	33,31	118	1092 19	40,59	156
1025 36 06	239,19	90	1052 70 04	33,31	118	1093 00	43,98	156
1025 36 09	239,19	90	1052 70 06	30,67	118	1093 09	43,98	156
1025 60 14	92,40	104	1052 70 09	29,14	118	1094	32,70	158
1025 60 16	92,40	104	1053 60 94	48,10	105	1094 09	32,70	158
1025 60 19	80,81	104	1053 60 99	48,10	105	1095	37,97	158
1025 60 83	301,19	106	1053 70 03	45,98	118	1095 09	37,97	158
1029 00 62	14,20	104	1053 70 04	45,98	118	1096 14 04 00	20,43	93
1029 00 69	12,51	104	1053 70 06	48,00	118	1096 16 06 00	14,27	93
1029 60 86	12,88	104	1053 70 09	45,98	118	1096 19 09 00	12,18	93
1030 00 62	19,67	104	1061	53,29	75	1096 20 45 00	24,69	137
1030 00 69	13,42	104	1064 20	25,18	162	1096 20 89 00	24,22	137
1030 60 86	22,11	104	1064 21	25,18	162	1096 60 84 00	24,34	110
1031 00 62	28,67	104	1077 71 03 00	19,86	120	1096 60 86 00	24,34	110
1031 00 69	16,55	104	1077 71 04 00	19,86	120	1096 60 89 00	21,50	110
1031 60 86	34,61	104	1077 71 06 00	18,87	120	1096 89 82 00	10,59	93
1033 14 04	12,72	96	1077 71 09 00	12,50	120	1096 89 89 00	10,59	93
1033 16 06	9,40	96	1079 71 03 00	89,86	121	1102	62,14	156
1033 19 09	6,66	96	1079 71 04 00	89,86	121	1102 09	62,14	156
1033 60 84	9,80	112	1079 71 06 00	89,18	121	1108 70 03	6,88	123
1033 60 86	9,80	112	1079 71 09 00	85,40	121	1108 70 04	6,88	123
1033 60 89	4,17	112	1079 72 03 00	89,86	121	1108 70 06	5,42	123
1033 89 12	5,91	96	1079 72 04 00	89,86	121	1108 70 09	3,62	123
1033 89 19	5,91	96	1079 72 06 00	89,18	121	1108 71 03	6,34	123
1035 70 03	13,93	123	1079 72 09 00	85,40	121	1108 71 04	6,34	123
1035 70 04	13,93	123	1079 73 03 00	89,86	121	1108 71 06	5,07	123
1035 70 06	9,88	123	1079 73 04 00	89,86	121	1108 71 09	3,62	123
1035 70 09	4,45	123	1079 73 06 00	89,18	121	1109 14 04	4,23	96
1037	11,65	164	1079 73 09 00	85,40	121	1109 14 14	3,55	96
1037 01	11,65	164	1080 14 04 00	20,43	93	1109 16 06	3,51	96
1038 20 45	7,25	139 , 163	1080 16 06 00	14,27	93	1109 16 16	2,69	96
1038 20 89	6,71	139 , 163	1080 19 09 00	12,96	93	1109 19 09	2,18	96
1039 20	7,64	162	1080 20 45 00	24,69	137	1109 19 19	3,51	96
1039 21	7,64	162	1080 20 89 00	24,22	137	1109 60 74	6,22	112
1040	20,44	163	1080 60 84 00	24,72	110	1109 60 76	6,22	112
1040 01	20,44	163	1080 60 86 00	24,72	110	1109 60 79	3,10	112
1041 16 06	14,64	89	1080 60 89 00	20,77	110	1109 60 84	5,84	112
1041 19 09	18,34	89	1080 89 82 00	10,49	93	1109 60 86	5,84	112
1041 70 03	23,28	118	1080 89 89 00	10,78	93	1109 60 89	3,10	112
1041 70 04	23,28	118	1081 14 04 00	94,67	93	1109 89 82	2,90	96
1041 70 06	19,47	118	1081 16 06 00	94,78	93	1109 89 89	2,51	96
1041 70 09	19,23	118	1081 19 09 00	92,69	93	1109 90 82	2,31	96
1041 89 35	13,01	134	1081 60 84 00	71,96	110	1109 90 89	2,31	96
1041 89 82	14,25	88	1081 60 86 00	71,96	110	1124 14 04	12,72	94
1041 89 89	14,25	88 , 134	1081 60 89 00	78,31	110	1124 16 06	8,86	94
1041 99 09	17,33	88	1081 89 82 00	59,97	93	1124 19 09	7,32	94
1041 99 39	23,28	88	1081 89 89 00	59,97	93	1124 20 45	6,25	137
1041 99 49	23,28	88	1082 19 09 00	92,69	93	1124 20 89	5,69	137
1042 16 06	25,04	89	1082 60 84 00	71,96	110	1124 60 84	8,15	110
1042 19 09	22,87	89	1082 60 86 00	71,96	110	1124 60 86	8,15	110
1042 70 03	33,31	118	1082 60 89 00	78,31	110	1124 60 89	4,61	110

Referencia	Precio €	Pág. tarifa	Referencia	Precio €	Pág. tarifa	Referencia	Precio €	Pág. tarifa
1124 89 82	2,84	94	1181 19 09	15,40	96	1309 39 04	32,83	89
1124 89 89	2,84	94	1181 20 45	19,33	139	1309 60 20	124,06	106
1130 89 82	7,35	88	1181 20 89	18,85	139	1309 60 30	124,06	106
1130 89 89	7,35	88	1181 60 84	17,47	113	1309 60 74	124,06	106
1130 99 09	11,18	88	1181 60 86	17,47	113	1309 60 76	103,37	106
1130 99 39	23,60	88	1181 60 89	11,97	113	1309 60 79	103,37	106
1130 99 49	23,60	88	1181 89 82	11,38	96	1309 60 83	124,06	106
1135 70 03	53,28	121	1181 89 89	11,38	96	1309 60 84	8,57	104
1135 70 04	53,28	121	1182 70 03	22,72	124	1309 60 86	8,57	104
1135 70 06	28,68	121	1182 70 04	22,72	124	1309 60 89	8,31	104
1135 70 09	28,50	121	1182 70 06	17,70	124	1309 60 94	8,57	105
1135 72 03	55,60	121	1182 70 09	15,75	124	1309 60 96	8,57	105
1135 72 04	55,60	121	1184 70 03	13,93	123	1309 60 99	8,31	105
1135 72 06	31,07	121	1184 70 04	13,93	123	1309 61 84	14,49	106
1135 72 09	30,80	121	1184 70 06	9,88	123	1309 61 86	14,49	106
1137 14 04	27,12	95	1184 70 09	8,77	123	1309 61 89	14,49	106
1137 14 24	29,26	94	1196 14 04	13,23	95	1309 64 14	58,14	90
1137 16 06	17,66	95	1196 16 06	9,40	95	1309 64 24	36,41	90
1137 16 26	19,89	94	1196 19 09	7,82	95	1309 66 16	58,14	90
1137 19 09	11,18	95	1196 20 35	22,80	162	1309 66 26	36,41	90
1137 19 29	13,41	94	1196 20 45	7,38	138	1309 69 04	213,01	90
1137 20 35	23,07	138	1196 20 79	22,80	162	1309 69 09	58,14	90
1137 20 45	14,63	138	1196 20 89	6,83	138	1309 69 14	213,01	90
1137 20 79	22,51	138	1196 60 84	9,61	112	1309 69 19	36,41	90
1137 20 89	14,52	138	1196 60 86	9,61	112	1309 70 03	19,07	118
1137 60 74	29,13	111	1196 60 89	7,92	112	1309 70 04	19,07	118
1137 60 76	29,13	111	1196 89 82	5,91	95	1309 70 06	11,24	118
1137 60 79	29,13	111	1196 89 89	5,91	95	1309 70 09	9,04	118
1137 60 84	26,95	111	1198 14 04	12,72	94	1309 89 82	3,47	88
1137 60 86	26,95	111	1198 16 06	8,59	94	1309 89 89	3,47	88
1137 60 89	26,95	111	1198 19 09	7,59	94	1309 99 09	3,60	88
1137 89 22	13,41	94	1198 20 45	6,65	137	1309 99 39	21,48	88
1137 89 29	13,41	94	1198 20 89	6,48	137	1309 99 49	21,48	88
1137 89 82	7,35	95	1198 60 84	16,22	110	1313 70 03	12,58	118
1137 89 89	7,35	95	1198 60 86	16,22	110	1313 70 04	12,58	118
1146 14 04	14,52	93	1198 60 89	15,37	110	1313 70 06	4,60	118
1146 16 06	10,40	93	1198 89 82	4,75	94	1313 70 09	2,38	118
1146 19 09	9,11	93	1198 89 89	4,75	94	1323 70 03	20,17	118
1146 20 45	7,73	137	1201 70 13	13,88	123	1323 70 04	20,17	118
1146 20 89	7,10	137	1201 70 14	13,88	123	1323 70 06	7,00	118
1146 60 84	10,65	110	1201 70 16	9,88	123	1323 70 09	4,60	118
1146 60 86	10,65	110	1201 70 19	6,56	123	1331 11	16,27	155
1146 60 89	8,79	110	1203 14 04	13,72	96	1331 19	16,27	155
1146 89 82	6,29	93	1203 16 06	9,70	96	1333 70 03	43,74	118
1146 89 89	6,29	93	1203 19 09	2,49	96	1333 70 04	43,74	118
1147 70 06	10,28	120	1203 20 45	7,25	162	1333 70 06	10,67	118
1147 70 09	9,20	120	1203 20 89	6,71	162	1333 70 09	6,84	118
1150 14 04	20,25	92	1203 60 84	9,61	112	1343 70 03	50,28	118
1150 16 06	19,64	92	1203 60 86	9,61	112	1343 70 04	50,28	118
1150 19 09	13,88	92	1203 60 89	5,89	112	1343 70 06	17,28	118
1150 60 89	19,41	109	1203 89 82	2,49	96	1343 70 09	9,35	118
1150 71 04	21,62	120	1203 89 89	2,49	96	1353 70 03	79,08	118
1150 71 06	20,67	120	1220	4,86	74	1353 70 04	79,08	118
1150 71 09	19,36	120	1221	19,03	163	1353 70 06	24,17	118
1150 89 82	13,36	92	1222	20,91	163	1353 70 09	15,20	118
1150 89 89	13,36	92	1225	9,52	163	1363 70 03	20,17	118
1154 71 03	28,55	123	1225 01	9,52	163	1363 70 04	20,17	118
1154 71 04	28,55	123	1226	21,06	163	1363 70 06	7,00	118
1154 71 06	17,57	123	1227	20,44	163	1363 70 09	4,60	118
1154 71 09	13,38	123	1229	21,30	163	1373 70 03	43,74	118
1165 70 03	12,03	121	1229 02	21,30	163	1373 70 04	43,74	118
1165 70 04	12,03	121	1230	4,86	74	1373 70 06	10,67	118
1165 70 06	8,24	121	1231	4,86	74	1373 70 09	6,84	118
1165 70 09	7,39	121	1232	4,86	74	1381 01	4,26	155
1167 70 03	12,72	121	1279	5,61	74	1381 09	4,26	155
1167 70 04	12,72	121	1279 02	5,61	74	1381 21	12,02	155
1167 70 06	8,93	121	1279 03	5,61	74	1381 29	12,02	155
1167 70 09	5,43	121	1280	3,69	74	1381 31	18,17	155
1170 14 04	22,23	96	1281	3,69	74	1381 39	18,17	155
1170 16 06	16,57	96	1282	3,69	74	1381 41	16,91	155
1170 19 09	11,31	96	1283	3,69	74	1381 49	16,91	155
1170 20 45	15,71	139	1309 30 01	37,25	89	1381 51	19,79	155
1170 20 89	15,34	139	1309 30 04	32,83	89	1381 59	19,79	155
1170 60 84	15,41	113	1309 30 05	37,25	89	1381 65	47,24	155
1170 60 86	15,41	113	1309 30 12	37,25	89	1381 69	47,24	155
1170 60 89	9,99	113	1309 30 16	37,25	89	1382 01	6,71	155
1170 70 03	19,73	124	1309 30 21	37,25	89	1382 09	6,71	155
1170 70 04	19,73	124	1309 30 22	37,25	89	1383 70 03	50,28	118
1170 70 06	15,68	124	1309 30 25	37,25	89	1383 70 04	50,28	118
1170 70 09	12,95	124	1309 30 46	56,50	89	1383 70 06	17,28	118
1181 14 04	22,87	96	1309 36 06	152,34	90	1383 70 09	9,35	118
1181 16 06	21,06	96	1309 36 09	152,34	90	1393 70 03	79,08	118

Referencia	Precio €	Pág. tarifa	Referencia	Precio €	Pág. tarifa	Referencia	Precio €	Pág. tarifa
1393 70 04	79,08	118	1435 70 03	21,63	120	1506 19 09	21,43	93
1393 70 06	24,17	118	1435 70 04	12,17	120	1506 20 45	19,09	137
1393 70 09	15,20	118	1435 70 06	12,03	120	1506 20 89	19,09	137
1403 02	9,88	97	1435 70 09	8,21	120	1506 60 84	19,13	110
1403 09	9,88	97 , 124	1435 71 03	15,00	120	1506 60 86	19,13	110
1403 14 04	18,50	97	1435 71 04	15,00	120	1506 60 89	18,53	110
1403 16 06	12,84	97 , 113 , 124	1435 71 06	15,00	120	1506 89 82	13,10	93
1403 19 09	9,75	97 , 113	1435 71 09	9,74	120	1506 89 89	13,10	93
1405 70 03	8,66	119	1437 70 03	15,00	120	1507 14 04	33,00	93
1405 70 04	8,66	119	1437 70 04	15,00	120	1507 16 06	23,88	93
1405 70 06	8,52	119	1437 70 06	15,00	120	1507 19 09	21,43	93
1405 70 09	3,08	119	1437 70 09	9,91	120	1507 20 45	8,72	137
1407	16,29	161	1458 01	11,04	96 , 123	1507 20 89	8,72	137
1407 01	16,29	161	1458 02	4,75	96	1507 60 84	20,15	110
1407 14 04	10,32	96	1458 09	4,75	96 , 123	1507 60 86	20,15	110
1407 16 06	7,31	96	1463 16 06	25,17	113	1507 60 89	18,53	110
1407 19 09	4,84	96	1463 19 09	26,95	113	1507 89 82	13,10	93
1407 20 45	7,25	139 , 161	1464 16 06	25,17	113	1507 89 89	13,10	93
1407 20 89	6,71	139 , 161	1464 19 09	26,95	113	1570 14 04	29,58	92
1407 60 84	9,61	112	1465 70 04	22,54	120	1570 16 06	27,89	92
1407 60 86	9,61	112	1465 70 06	14,87	120	1570 19 09	24,81	92
1407 60 89	6,39	112	1465 70 09	23,01	120	1571 14 04	17,30	93
1407 70 03	11,07	123	1468 01	11,62	123	1571 16 06	18,55	93
1407 70 04	11,07	123	1468 09	3,79	123	1571 19 09	18,74	93
1407 70 06	7,84	123	1469 01	11,62	124	1572 14 04	32,00	92
1407 70 09	6,95	123	1469 09	5,54	124	1572 16 06	30,19	92
1407 89 82	4,84	96	1470 09	18,96	97 , 124	1572 19 09	29,94	92
1407 89 89	4,84	96	1470 19 09	20,50	97 , 113	1573 14 04	29,09	92
1409	25,18	161	1474 02	8,35	97	1573 16 06	27,59	92
1409 01	25,18	161	1474 04	25,92	97 , 124	1573 19 09	26,83	92
1409 14 04	12,47	96	1474 09	8,35	97 , 124	1577 14 04	30,94	93
1409 16 06	8,82	96	1474 14 04	14,52	97 , 113	1577 16 06	29,78	93
1409 19 09	7,10	96	1474 16 06	10,78	97 , 113 , 124	1577 19 09	29,04	93
1409 20 45	7,25	139 , 161	1474 19 09	9,11	97 , 113	1600	11,46	76
1409 20 89	6,71	139 , 161	1480 02	21,06	97	1600 02	9,68	76
1409 60 84	9,61	113	1480 09	21,06	97 , 124	1601	7,23	74
1409 60 86	9,61	113	1480 19 09	23,97	97 , 113	161	33,18	80
1409 60 89	6,39	113	1483 01	11,16	96	1610 03	11,18	74
1409 70 03	13,93	123	1483 02	4,75	96	1610 13	11,18	74
1409 70 04	13,93	123	1483 04	16,57	96 , 123	1620 14 04	7,31	92
1409 70 06	9,88	123	1483 09	4,75	96 , 123	1620 16 06	3,40	92
1409 70 09	8,65	123	1483 11	13,36	96	1620 19 09	1,80	92
1409 89 82	5,78	96	1483 14 04	12,59	96	1620 20 15	7,50	136
1409 89 89	5,78	96	1483 16 06	8,35	96 , 112 , 123	1620 20 25	7,50	136
1411 09	9,50	97 , 124	1483 19 09	5,12	96 , 112	1620 20 35	7,50	136
1411 19 09	9,64	97 , 113	1484 01	11,04	96	1620 20 45	6,41	136
1412 02	10,03	95	1484 02	5,12	96	1620 20 59	3,51	136
1412 09	10,03	95 , 123	1484 04	13,36	96 , 123	1620 20 69	3,51	136
1412 14 04	20,54	95	1484 09	5,12	96 , 123	1620 20 79	3,51	136
1412 16 06	13,99	95 , 112 , 123	1484 11	13,36	96	1620 20 89	2,99	136
1412 19 09	11,16	95 , 112 , 123	1484 14 04	12,59	96	1620 60 44	6,52	109
1415 70 03	13,97	119	1484 16 06	8,35	96 , 112 , 123	1620 60 46	6,52	109
1415 70 04	13,97	119	1484 19 09	5,02	96 , 112	1620 60 49	3,64	109
1415 70 06	10,13	119	1484 20 45	7,25	138 , 162	1620 60 54	6,52	109
1415 70 09	7,11	119	1484 20 89	6,71	138 , 162	1620 60 56	6,52	109
1415 71 03	18,13	119	1492 02	20,43	97	1620 60 59	3,64	109
1415 71 04	14,19	119	1492 09	20,43	97 , 124	1620 60 64	6,52	109
1415 71 06	13,93	119	1492 19 09	23,97	97 , 113	1620 60 66	6,52	109
1415 71 09	13,23	119	1494 02	5,27	97	1620 60 69	3,64	109
1417 71 03	11,62	120	1494 09	5,27	97 , 124	1620 60 84	4,91	109
1417 71 04	11,62	120	1494 16 06	8,35	97 , 124	1620 60 86	4,91	109
1417 71 06	11,50	120	1494 19 09	5,78	97 , 113 , 124	1620 60 89	2,81	109
1417 71 09	7,11	120	1495 19 09	9,69	97 , 113 , 124	1620 89 82	1,68	92
1425 71 03	10,13	120	1496 70 03	14,19	119	1620 89 89	1,68	92
1425 71 04	10,13	120	1496 70 04	14,19	119	1621 14 04	10,32	92
1425 71 06	10,13	120	1496 70 06	13,93	119	1621 16 06	6,91	92
1425 71 09	5,57	120	1496 70 09	13,38	119	1621 19 09	3,35	92
1426 70 03	12,72	119	1499 14 04	11,07	96	1621 20 35	7,50	136
1426 70 04	12,72	119	1499 16 06	8,09	96	1621 20 45	7,50	136
1426 70 06	12,58	119	1499 19 09	6,55	96	1621 20 79	6,72	136
1426 70 09	12,13	119	1499 89 82	5,78	96	1621 20 89	4,84	136
1427 16 06	22,37	113	1499 89 89	5,78	96	1621 60 74	14,93	109
1427 19 09	19,94	113	1504 71 03	26,22	121	1621 60 76	14,93	109
1431 02	9,88	97	1504 71 04	26,22	121	1621 60 79	11,69	109
1431 04	20,67	97 , 124	1504 71 06	20,00	121	1621 60 84	14,55	109
1431 09	9,88	97 , 124	1504 71 09	20,33	121	1621 60 86	14,55	109
1431 14 04	18,75	97	1505 70 03	26,22	121	1621 60 89	10,27	109
1431 16 06	14,89	97 , 113 , 124	1505 70 04	26,22	121	1621 89 82	3,35	92
1431 19 09	11,74	97 , 113	1505 70 06	20,00	121	1621 89 89	4,97	92
1431 70 03	12,36	124	1505 70 09	20,33	121	1622 14 04	8,44	92
1432 20 45	11,86	138	1506 14 04	33,00	93	1622 16 06	6,29	92
1432 20 89	8,35	138	1506 16 06	23,88	93	1622 19 09	4,48	92

Referencia	Precio €	Pág. tarifa	Referencia	Precio €	Pág. tarifa	Referencia	Precio €	Pág. tarifa
1622 20 45	7,50	136	1633 89 82	11,16	94	1679	27,25	74
1622 20 89	5,24	136	1633 89 89	11,16	94	1679 01	17,39	74
1622 60 84	16,22	109	1634 71 03	23,78	121	1679 02	17,39	74
1622 60 86	16,22	109	1634 71 04	23,78	121	1679 03	27,26	74
1622 60 89	13,21	109	1634 71 06	21,22	121	1679 04	32,88	74
1622 89 82	5,27	92	1634 71 09	21,60	121	1680	18,89	76
1622 89 89	5,27	92	1635 71 03	23,78	121	1680 00	54,51	157
1623 14 04	10,20	92	1635 71 04	23,78	121	1680 01	54,51	157
1623 16 06	6,66	92	1635 71 06	21,22	121	1680 50	123,04	107
1623 19 09	3,20	92	1635 71 09	21,60	121	1680 55	123,04	107
1623 20 45	9,12	136	1640 14 04	70,56	93	1686	18,89	76
1623 20 89	4,23	136	1640 16 06	38,49	93	1686 01	18,89	76
1623 60 84	8,51	109	1640 19 09	12,71	93	1687	18,89	76
1623 60 86	8,51	109	1640 20 35	81,49	163	1696 14 04	15,53	92
1623 60 89	7,41	109	1640 20 45	85,65	138	1696 16 06	11,71	92
1623 89 82	3,09	92	1640 20 79	81,49	163	1696 19 09	10,68	92
1623 89 89	3,09	92	1640 20 89	85,39	138	1696 60 74	17,58	109
1624 14 04	10,45	92	1640 60 84	51,02	110	1696 60 76	17,58	109
1624 16 06	7,31	92	1640 60 86	51,02	110	1696 60 79	17,44	109
1624 19 09	9,00	92	1640 60 89	50,09	110	1696 60 84	20,11	109
1624 20 45	7,50	136	1640 60 94	93,54	111	1696 60 86	20,11	109
1624 20 89	6,72	136	1640 60 96	93,54	111	1696 60 89	12,14	109
1624 60 84	15,24	109	1640 60 99	89,65	111	1696 89 82	11,20	92
1624 60 86	15,24	109	1640 89 82	11,38	93	1696 89 89	11,15	92
1624 60 89	11,64	109	1640 89 84	93,12	95	1719 14 04	6,65	91
1624 89 82	6,55	92	1640 89 89	11,38	93	1719 16 06	5,27	91
1624 89 89	6,55	92	1640 89 92	91,28	95	1719 19 09	4,94	91
1625 14 04	14,86	92	1640 89 99	91,28	95	1719 19 12	5,04	91
1625 16 06	11,59	92	1640 99 06	91,91	95	1719 20 22	5,12	136
1625 19 09	7,46	92	1640 99 09	91,28	95	1719 20 45	5,60	136
1625 20 45	11,29	137	1641 71 03	42,30	120	1719 20 89	5,12	136
1625 20 89	5,25	137	1641 71 04	42,30	120	1719 60 12	5,06	108
1625 60 84	11,46	109	1641 71 06	38,51	120	1719 60 84	6,97	108
1625 60 86	11,46	109	1641 71 09	22,85	120	1719 60 86	6,97	108
1625 60 89	8,31	109	1641 71 14	104,43	122	1719 60 89	4,96	108
1625 89 82	6,66	92	1641 71 16	99,14	122	1719 70 03	10,40	119
1625 89 89	6,66	92	1641 71 19	95,95	122	1719 70 04	10,40	119
1626 14 04	12,59	92	1641 71 34	104,43	122	1719 70 06	5,90	119
1626 16 06	9,07	92	1647	12,52	158	1719 70 09	5,73	119
1626 19 09	8,35	92	1647 01	12,52	158	1719 70 15	6,21	119
1626 60 84	11,94	109	1647 65 00	77,25	158	1719 89 12	4,67	91
1626 60 86	11,94	109	1647 69 00	46,20	158	1719 89 82	4,58	91
1626 60 89	10,98	109	1651 19 49	11,52	93	1719 89 89	4,58	91
1626 89 82	7,32	92	1651 19 59	11,52	93	1720 20 45	23,44	136
1626 89 89	7,32	92	1651 19 69	11,52	93	1720 20 89	20,65	136
1627 14 04	12,47	92	1651 20 49	29,57	137	1720 60 84	13,85	108
1627 16 06	8,82	92	1651 20 69	29,52	137	1720 60 86	13,85	108
1627 19 09	10,67	92	1651 20 89	29,52	137	1720 60 89	14,11	108
1627 20 45	11,29	137	1651 60 49	21,80	110	1720 72 03	23,32	119
1627 20 89	9,05	137	1651 60 59	21,68	110	1720 72 04	23,32	119
1627 60 84	23,37	109	1651 71 09	13,65	120	1720 72 06	14,92	119
1627 60 86	23,37	109	1651 72 09	13,65	120	1720 72 09	14,65	119
1627 60 89	15,46	109	1651 73 09	13,65	120	181200	41,35	158
1627 89 82	9,64	92	1661 19 49	12,96	93	18120100	48,12	158
1627 89 89	9,64	92	1661 20 49	38,59	137	1813	1,57	155 , 182
1628 14 04	13,72	92	1661 60 49	24,31	110	1813 05	2,26	155 , 182
1628 16 06	10,32	92	1661 71 09	14,77	120	1813 09	2,26	155 , 182
1628 19 09	9,64	92	1665 14 04	17,50	92	1817 05	4,38	155 , 182
1628 60 74	18,36	109	1665 16 06	14,86	92	1817 09	4,38	155 , 182
1628 60 76	18,36	109	1665 19 09	11,95	92	1818	46,55	75
1628 60 79	12,37	109	1665 20 45	20,72	137	1818 01	55,96	75
1628 60 84	18,98	109	1665 20 89	19,95	137	1823 05	3,63	155
1628 60 86	18,98	109	1665 60 89	11,62	109	1823 09	3,63	155
1628 60 89	12,37	109	1665 89 82	10,51	92	1849	1,50	75
1628 89 82	8,59	92	1665 89 89	10,51	92	1861	3,83	71 , 160
1628 89 89	8,59	92	1674 14 04	29,26	94	1861 01	2,82	160
1632 14 04	31,07	94	1674 16 06	19,89	94	1872 00 10	2,60	135
1632 16 06	22,23	94	1674 19 09	13,41	94	1872 00 20	3,86	135
1632 19 09	19,39	94	1674 60 89	24,48	111	1872 00 30	5,12	135
1632 20 45	24,10	137	1674 89 82	13,41	94	1872 00 40	6,43	135
1632 20 89	23,53	137	1674 89 89	13,41	94	1872 10 10	2,60	135
1632 60 86	26,18	111	1675	4,23	76	1872 10 20	3,86	135
1632 60 89	19,69	111	1675 04	6,81	76	1872 10 30	5,12	135
1632 89 82	11,16	94	1676	8,46	76	1872 10 40	6,43	135
1632 89 89	11,16	94	1676 01	8,46	76	1887	1,10	164
1633 14 04	31,07	94	1676 02	8,46	76	1905 00 02	4,63	96
1633 16 06	22,23	94	1676 03	13,67	76	1905 00 69	4,63	96 , 112 , 123
1633 19 09	19,39	94	1678	19,80	74	1905 70 03	8,04	123
1633 20 45	24,10	137	1678 01	12,83	74	1905 70 04	7,64	96 , 123
1633 20 89	23,53	137	1678 02	12,83	74	1905 80 01	10,98	73
1633 60 86	26,18	111	1678 03	28,62	74	1905 80 02	10,98	73
1633 60 89	19,69	111	1678 04	18,81	74	1905 80 03	10,98	73

Referencia	Precio €	Pág. tarifa	Referencia	Precio €	Pág. tarifa	Referencia	Precio €	Pág. tarifa
1905 80 04	10,98	73	2952 14 04	130,33	73	33 1541 60 84	114,66	112
1905 80 05	10,98	73	2952 16 06	122,58	73	33 1541 60 86	114,66	112
1905 80 06	10,98	73 , 163	2952 19 09	116,21	73	33 1541 60 89	78,71	112
1905 80 07	10,98	73 , 163	2952 20 45	122,58	73 , 163	33 1541 70 03	103,02	122
1905 80 08	10,98	73 , 163	2952 20 89	122,40	73 , 163	33 1541 70 04	103,02	122
1905 80 09	10,98	73 , 163	2952 60 84	122,58	73	33 1541 70 06	92,86	122
1905 80 10	10,98	73 , 163	2952 60 86	122,58	73	33 1541 70 09	85,62	122
1905 80 11	12,32	73	2952 60 89	116,21	73	33 1541 89 82	79,09	95
1905 80 12	12,32	73	2952 70 03	130,33	73	33 1541 89 89	79,09	95
1905 80 13	12,32	73 , 163	2952 70 04	130,33	73	33 1542 14 04	201,58	95
1905 80 14	12,32	73 , 163	2952 70 06	122,58	73	33 1542 16 06	196,77	95
1913	1,64	75	2952 70 09	122,40	73	33 1542 19 09	180,58	95
1914	1,64	75	2952 89 82	116,21	73	33 1542 20 45	121,73	138
1980	23,51	72 , 180	2952 89 89	116,21	73	33 1542 20 89	121,00	138
1984	32,14	72 , 180	2953 14 04	116,29	73	33 1542 60 84	158,27	112
1985	37,28	72 , 180	2953 16 06	108,68	73	33 1542 60 86	158,27	112
1990	5,53	71 , 180	2953 19 09	102,41	73	33 1542 60 89	179,71	112
1992	32,77	71 , 180	2953 20 45	108,68	73 , 163	33 1542 70 03	217,28	123
1993	55,96	71 , 180	2953 20 89	108,47	73 , 163	33 1542 70 04	217,28	123
1994	122,86	71 , 180	2953 60 84	108,68	73	33 1542 70 06	207,12	123
2026 14 04	130,97	95	2953 60 86	108,68	73	33 1542 70 09	192,41	123
2026 16 06	125,84	95	2953 60 89	102,41	73	33 1542 89 82	180,58	95
2026 19 09	118,13	95	2953 70 03	116,29	73	33 1542 89 89	180,58	95
2026 20 45	99,60	138	2953 70 04	116,29	73	33 1543 14 04	201,58	95
2026 20 89	96,69	138	2953 70 06	108,68	73	33 1543 16 06	196,77	95
2026 60 84	127,28	111	2953 70 09	108,47	73	33 1543 19 09	180,58	95
2026 60 86	127,28	111	2953 89 82	102,41	73	33 1543 20 45	121,73	138
2026 60 89	113,99	111	2953 89 89	102,41	73	33 1543 20 89	121,00	138
2026 71 03	128,42	122	2961 10	134,91	81	33 1543 60 84	158,27	112
2026 71 04	128,42	122	2962 10	85,83	81	33 1543 60 86	158,27	112
2026 71 06	123,01	122	2973	88,90	81	33 1543 60 89	179,71	112
2026 71 09	121,66	122	2997	76,65	81	33 1543 70 03	217,28	123
2026 89 82	104,02	95	2998	153,31	81	33 1543 70 04	217,28	123
2026 89 89	104,02	95	3031	4,91	70	33 1543 70 06	207,12	123
2030 14 04	130,97	95	3032	12,29	70	33 1543 70 09	192,41	123
2030 16 06	125,84	95	3032 12	26,75	70	33 1543 89 82	180,58	95
2030 19 09	118,13	95	3033 03	20,87	70	33 1543 89 89	180,58	95
2030 20 45	98,18	138	3035	7,36	70	3811 03	39,08	160
2030 20 89	95,27	138	3035 20	16,94	71	3811 13	39,08	160
2030 60 84	125,41	111	3035 50	16,50	70	3811 21 45	39,37	160
2030 60 86	125,41	111	3036	5,61	70	3811 21 89	39,37	160
2030 60 89	113,99	111	3036 50	10,92	70	3812 03	45,22	160
2030 71 03	128,42	122	3037	11,63	70	3812 13	45,22	160
2030 71 04	128,42	122	3038 08	18,30	70	3812 21 45	45,55	160
2030 71 06	128,42	122	33 1532 14 04	177,47	95	3812 21 89	45,55	160
2030 71 09	121,66	122	33 1532 16 06	172,65	95	3822 10	112,49	71
2030 89 82	104,02	95	33 1532 19 09	157,97	95	3826 10	150,43	70
2030 89 89	104,02	95	33 1532 20 45	106,80	138	3831 10	104,43	71
2034 14 04	369,95	95	33 1532 20 89	106,07	138	3832 10	112,49	71
2034 16 06	365,04	95	33 1532 60 84	138,85	112	3838 03	30,33	157
2034 19 09	357,54	95	33 1532 60 86	138,85	112	3841 03	29,35	71
2034 20 45	197,73	138	33 1532 60 89	157,22	112	3842 03	41,52	71
2034 20 89	194,80	138	33 1532 70 03	191,90	122	3846 03	24,44	157
2034 60 84	254,89	111	33 1532 70 04	191,90	122	3851 03	32,35	71
2034 60 86	254,89	111	33 1532 70 06	181,74	122	3852 03	42,87	71
2034 60 89	360,96	111	33 1532 70 09	168,69	122	3856 20	133,42	70
2034 71 03	399,63	122	33 1532 89 82	157,97	95	3861 03	34,12	70
2034 71 04	399,63	122	33 1532 89 89	157,97	95	3861 13	57,75	70
2034 71 06	387,58	122	33 1539 19 09	103,87	95	3862	103,75	70
2034 71 09	381,78	122	33 1539 20 89	70,21	138	3862 01	117,11	70
2034 89 82	357,54	95	33 1539 60 86	92,31	112	3875 03	23,06	157
2034 89 89	357,54	95	33 1539 70 03	130,92	123	3876 03	18,80	157
2040	141,84	75	33 1539 89 82	103,87	95	3877 03	36,84	157
2041	197,67	75	33 1540 14 04	93,06	95	3893 03	35,43	157
2602 05	67,63	71	33 1540 16 06	88,22	95	3956 19	25,68	70
2602 09	67,63	71	33 1540 19 09	79,09	95	3966	18,99	70
2602 15	67,93	163	33 1540 20 45	85,40	138	4109 14 04	95,82	91
2602 19	67,93	163	33 1540 20 89	73,21	138	4109 16 06	93,63	91
2873	85,65	80	33 1540 60 84	111,27	112	4109 19 09	93,53	91
2891 10	55,96	80	33 1540 60 86	111,27	112	4109 20 45	110,27	136 , 157
2909	46,00	81	33 1540 60 89	78,71	112	4109 20 89	110,27	136 , 157
2913	39,89	81	33 1540 70 03	103,02	122	4109 60 84	95,74	108
2944 10	197,43	159	33 1540 70 04	103,02	122	4109 60 86	95,74	108
2944 11	197,43	159	33 1540 70 06	92,86	122	4109 60 89	95,74	108
2944 20 45	197,43	159	33 1540 70 09	85,62	122	4109 70 03	102,56	119
2944 20 89	197,43	159	33 1540 89 82	79,09	95	4109 70 04	101,05	119
2945 10	142,78	159	33 1540 89 89	79,09	95	4109 70 06	100,77	119
2945 11	142,78	159	33 1541 14 04	93,06	95	4109 70 09	98,03	119
2945 20 45	142,78	159	33 1541 16 06	88,22	95	4109 89 82	93,63	91
2945 20 89	142,78	159	33 1541 19 09	79,09	95	4109 89 89	93,53	91
2948	153,62	80	33 1541 20 45	79,73	138	4110 19 09	26,36	91
2948 10	148,94	80	33 1541 20 89	81,04	138	4110 20 45	97,65	136

Referencia	Precio €	Pág. tarifa	Referencia	Precio €	Pág. tarifa	Referencia	Precio €	Pág. tarifa
4110 20 89	97,65	136	5031 50	12,42	70	67 6879 01	15,91	157
4110 60 84	82,41	108	5032 03	19,05	70	67 6879 20 45	21,27	157
4110 60 86	82,41	108	5034 04	21,14	71	67 6879 20 89	21,27	157
4110 60 89	82,41	108	5035	11,18	70	68 1033 14 04	7,06	97
4110 70 09	49,97	119	5035 01	16,37	70	68 1033 16 06	7,06	97
4110 89 82	26,36	91	5035 03	17,07	70	68 1033 19 09	4,79	97
4110 89 89	26,36	91	5035 20	16,11	71	68 1033 20 45	8,83	137
4142 89 82	7,31	91	5036	8,74	70	68 1033 20 89	5,48	137
4142 89 89	7,31	91	5038 08	31,13	70	68 1033 60 84	7,56	113
4142 99 09	7,31	91	5038 08 01	14,80	70	68 1033 60 86	7,56	113
4149 14 04	20,03	91	5038 08 02	14,80	70	68 1033 60 89	5,07	113
4149 16 06	15,67	91	5051 02	11,87	70	68 1033 89 82	4,53	97
4149 19 09	14,13	91	5051 03	17,75	70	68 1033 89 89	4,53	97
4149 60 84	13,29	108	5052 01	28,79	70	68 1034 70 03	13,25	124
4149 60 86	13,29	108	5056 01	11,87	70	68 1034 70 04	13,25	124
4149 60 89	13,29	108	5101	8,48	74	68 1034 70 06	9,01	124
4149 89 82	13,10	91	5101 10	13,92	74	68 1034 70 09	5,57	124
4149 89 89	13,10	91	5101 89 82	32,11	93	7141 34	5,82	71
4468	11,06	75	5101 89 89	32,11	93	73 4123 20 89	10,28	136
4470	13,40	75	5101 99 09	32,11	93	73 4123 60 89	10,06	108
4502 10	20,48	71	5104	26,44	163	73 4123 89 89	9,72	91
4505	14,76	72	5104 01	26,44	163	73 4135 70 09	10,82	119
4505 02	60,80	71	5131 02	14,61	74	7594 04 02	4,46	95
4508 20	40,10	162	5200 60 89	294,84	111	7594 04 03	17,34	95
4508 21	40,10	162	5200 60 99	294,84	111	7594 04 04	17,34	95
4522 10	20,48	71	5200 70 09	305,76	122	7594 04 09	4,46	95
4538	11,61	72	5200 89 82	291,87	94	7594 04 83	13,83	95
4540 01	8,33	72	5200 89 89	291,87	94	7594 04 85	11,49	95
4540 02	12,01	72	5200 99 09	291,87	94	7594 04 89	4,46	95
4540 04	8,33	72	5201 60 89	38,22	111	7594 10 01	11,51	80
4541 01	8,33	72	5201 60 99	38,22	111	8 1836	2,79	182
4541 04	8,33	72	5201 70 09	39,31	122	8 1836 01	2,79	182
4541 05	12,01	72	5201 89 82	37,31	94	8 1836 02	2,24	182
4541 07	12,01	72	5201 89 89	37,31	94	8 1837	3,06	182
4541 09	10,73	72	5201 99 09	37,31	94	8 4516 25 68	15,49	178
4554 01	28,10	72	5202 60 89	38,22	111	8 4558 25 05	8,55	180
4555 01	36,15	72	5202 60 99	38,22	111	8 4558 25 07	8,55	180
4572 05	26,35	71	5202 70 09	39,31	122	8 4558 25 09	8,55	180
4572 09	26,35	71	5202 89 82	37,31	94	8 4558 25 10	8,55	180
4573 05	28,67	71	5202 89 89	37,31	94	8 4563 25 03	23,83	180
4573 09	28,67	71	5202 99 09	37,31	94	8 4563 25 06	23,83	180
4582	557,64	72	5203 60 89	155,06	111	8 4571 25 01	14,83	180
4583	670,38	72	5203 60 99	155,06	111	8 4571 25 03	14,83	180
4588	51,29	72	5203 70 09	156,16	122	8 4571 25 05	14,83	180
4594 10	26,77	71	5203 89 82	153,62	94	8 4571 25 07	14,83	180
4604	41,05	75	5203 89 89	153,62	94	8 4571 25 09	14,83	180
4605	32,82	75	5203 99 09	153,62	94	8 6254 25 01	107,27	179
4637	4,92	180	5204 60 89	103,74	111	8 6254 25 05	107,27	179
4738 70 03	21,36	119	5204 60 99	103,74	111	8 6254 25 07	107,27	179
4738 70 04	21,36	119	5204 70 09	104,83	122	8 6254 25 09	107,27	179
4738 70 06	18,38	119	5204 89 82	103,14	94	8 6254 25 10	107,27	179
4738 70 09	17,69	119	5204 89 89	103,14	94	8 6263 25 01	28,11	179
4755	32,96	157	5204 99 09	103,14	94	8 6263 25 02	28,11	179
4755 01	32,96	157	5205 60 89	102,65	111	8 6263 25 13	28,11	179
4755 20 45	19,78	157	5205 60 99	102,65	111	9 1151 25 01	10,42	182
4755 20 89	19,78	157	5205 70 09	103,74	122	9 1151 25 05	10,42	182
4803 14 04	76,29	91	5205 89 82	102,60	94	9 1151 25 07	16,28	182
4803 16 06	76,29	91	5205 89 89	102,60	94	9 1151 25 09	10,42	182
4803 19 09	73,25	91	5205 99 09	102,60	94	9 1151 25 10	15,97	182
4803 60 84	78,96	108	5206 60 89	38,22	111	9 1151 25 11	12,20	182
4803 60 86	78,96	108	5206 60 99	38,22	111	9 1151 25 15	12,20	182
4803 60 89	76,78	108	5206 70 09	39,31	122	9 1151 25 17	12,20	182
4803 70 03	90,01	119	5206 89 82	37,31	94	9 1151 25 19	12,20	182
4803 70 04	90,01	119	5206 89 89	37,31	94	9 1151 25 20	15,93	182
4803 70 06	86,73	119	5206 99 09	37,31	94	9 1152 25 25	4,49	182
4803 70 09	83,52	119	53 1884	2,41	55	9 1152 25 29	7,22	182
4803 89 82	73,25	91	63 3023	29,62	70	9 1152 25 55	12,69	182
4803 89 89	73,25	91	67 1009 14 04	17,88	94	9 1152 25 59	12,80	182
4804 14 04	93,70	91	67 1009 16 06	13,97	94	9 1152 25 65	6,27	182
4804 16 06	89,59	91	67 1009 19 09	10,78	94	9 1152 25 69	16,40	182
4804 19 09	87,00	91	67 1009 20	34,22	164	9 1803 25 05	7,95	178
4804 60 84	93,26	108	67 1009 21	34,22	164	9 1803 25 07	7,95	178
4804 60 86	89,17	108	67 1009 60 84	14,72	110	9 1803 25 09	7,95	178
4804 60 89	86,58	108	67 1009 60 86	14,72	110	9 1803 25 68	27,79	178
4804 70 03	95,40	119	67 1009 60 89	12,40	110	9 1819 25 07	5,17	178
4804 70 04	95,40	119	67 1009 89 82	10,67	94	9 1819 25 10	5,17	178
4804 70 06	93,94	119	67 1009 89 89	10,67	94	9 1819 25 11	5,17	178
4804 70 09	92,61	119	67 1045 70 03	19,45	121	9 1819 25 15	5,17	178
4804 89 82	87,00	91	67 1045 70 04	19,45	121	9 1819 25 19	5,17	178
4804 89 89	87,00	91	67 1045 70 06	15,30	121	9 1819 25 24	27,63	178
5031	6,02	70	67 1045 70 09	13,65	121	9 1819 25 68	27,63	178
5031 01	11,18	70	67 6879	15,91	157	9 1820	2,74	182

Referencia	Precio €	Pág. tarifa	Referencia	Precio €	Pág. tarifa	Referencia	Precio €	Pág. tarifa
9 1820 01	2,55	182	9 3655 25 68	37,97	181	9 4560 25 06	21,32	180
9 1825 25 06	3,48	182	9 3656 25 01	13,79	181	9 4561 25 02	21,32	180
9 1825 25 10	3,48	182	9 3656 25 05	13,79	181	9 4581 25 01	11,22	180
9 1825 25 11	3,48	182	9 3656 25 07	13,79	181	9 4581 25 02	11,22	180
9 1825 25 12	3,48	182	9 3656 25 09	13,79	181	9 4581 25 03	11,22	180
9 1825 25 15	3,48	182	9 3656 25 10	13,79	181	9 4581 25 05	11,22	180
9 1825 25 24	13,54	182	9 3656 25 24	25,86	181	9 4581 25 06	11,22	180
9 1825 25 68	13,54	182	9 3656 25 68	25,86	181	9 6184 05	12,02	179
9 1826 25 07	3,48	178	9 3657 25 05	24,87	181	9 6184 25 01	12,02	179
9 1826 25 10	3,48	178	9 3657 25 07	24,87	181	9 6185 05	11,54	179
9 1826 25 11	3,48	178	9 3657 25 09	24,87	181	9 6185 25 01	11,54	179
9 1826 25 15	3,48	178	9 3657 25 10	24,87	181	9 6185 25 02	11,54	179
9 1826 25 19	3,48	178	9 3657 25 24	33,79	181	9 6185 25 05	11,54	179
9 1826 25 24	20,71	178	9 3671 25 01	11,86	181	9 6185 25 06	11,54	179
9 1826 25 58	20,71	178	9 3671 25 05	11,86	181	9 6194 05	13,60	179
9 1827 25 01	1,45	178	9 3671 25 07	11,86	181	9 6194 25 02	13,60	179
9 1827 25 05	1,45	178	9 3671 25 09	11,86	181	9 6194 25 05	13,60	179
9 1827 25 07	1,45	178	9 3671 25 10	11,86	181	9 6194 25 06	13,60	179
9 1827 25 09	1,45	178	9 3671 25 24	25,81	181	9 6195 05	12,12	179
9 1827 25 10	1,45	178	9 3671 25 68	25,81	181	9 6195 25 01	12,12	179
9 1827 25 18	14,77	178	9 3675 25 01	20,36	181	9 6195 25 02	12,12	179
9 1827 25 24	16,25	178	9 3675 25 05	20,36	181	9 6195 25 05	12,12	179
9 1827 25 58	16,25	178	9 3675 25 07	20,36	181	9 6195 25 06	12,12	179
9 1827 25 68	19,31	178	9 3675 25 09	20,36	181	9 6249 05	28,11	179
9 1827 25 76	1,32	178	9 3675 25 10	20,36	181	9 6249 25 01	28,11	179
9 1827 25 91	1,61	178	9 3675 25 24	44,37	181	9 6249 25 02	28,11	179
9 1827 25 95	1,61	178	9 3675 25 68	44,37	181	9 6249 25 05	28,11	179
9 1827 25 97	1,61	178	9 3752 25 01	23,43	181	9 6249 25 06	28,11	179
9 1827 25 99	1,61	178	9 3752 25 05	23,43	181	9 6256 05	62,99	179
9 1828 25 01	5,16	178	9 3752 25 07	23,43	181	9 6256 25 01	62,99	179
9 1828 25 05	5,16	178	9 3752 25 09	23,43	181	9 6256 25 02	62,99	179
9 1828 25 07	5,16	178	9 3752 25 10	23,43	181	9 6256 25 05	62,99	179
9 1828 25 09	5,16	178	9 3752 25 24	28,99	181	9 6256 25 06	62,99	179
9 1828 25 10	5,16	178	9 3752 25 68	28,99	181	9 6257 25 01	19,11	179
9 1828 25 24	22,78	178	9 3762 25 10	50,66	181	9 6257 25 02	19,11	179
9 1828 25 68	23,60	178	9 3762 25 24	60,15	181	9 6257 25 03	19,11	179
9 1828 25 76	6,29	178	9 3762 25 31	50,66	181	9 6257 25 05	19,11	179
9 1828 25 78	22,78	178	9 3762 25 35	50,66	181	9 6257 25 06	19,11	179
9 1828 25 86	6,74	178	9 3762 25 39	50,66	181	9 6259 25 01	28,11	179
9 1828 25 90	6,74	178	9 3762 25 68	60,15	181	9 6259 25 02	28,11	179
9 1828 25 91	6,74	178	9 3772 25 01	26,76	181	9 6259 25 03	28,11	179
9 1828 25 95	6,74	178	9 3772 25 05	26,76	181	9 6259 25 05	28,11	179
9 1828 25 97	6,74	178	9 3772 25 07	26,76	181	9 6259 25 06	28,11	179
9 1828 25 99	6,74	178	9 3772 25 09	26,76	181	9 6262 05	18,49	179
9 1844	2,24	182	9 4195 05	11,39	179	9 6262 25 01	18,49	179
9 1853	2,24	182	9 4195 25 01	11,39	179	9 6262 25 02	18,49	179
9 1883	3,06	182	9 4195 25 02	11,39	179	9 6262 25 05	18,49	179
9 1887	3,21	182	9 4195 25 05	11,39	179	9 6262 25 06	18,49	179
9 1915 01	9,76	182	9 4195 25 06	11,39	179	9 6272 05	19,97	179
9 1915 02	4,49	182	9 4511 15	7,69	180	9 6272 25 02	19,97	179
9 1933	6,41	182	9 4511 25 11	7,69	180	9 6272 25 05	19,97	179
9 1988 25 02	16,52	178	9 4511 25 12	7,69	180	9 6272 25 06	19,97	179
9 1988 25 04	16,52	178	9 4511 25 15	7,69	180			
9 1988 25 05	16,52	178	9 4511 25 16	7,69	180	<b>B</b>		
9 1988 25 06	16,52	178	9 4516 25 01	3,84	178	BBH03	55,00	75
9 1988 25 76	16,52	178	9 4516 25 05	3,84	178			
9 2610 25 05	118,50	180	9 4516 25 07	3,84	178	<b>M</b>		
9 2610 25 09	118,50	180	9 4516 25 09	3,84	178	MAH01	199,95	173
9 2891 25 01	114,18	181	9 4516 25 10	3,84	178	MAH02	214,98	173
9 2891 25 05	114,18	181	9 4516 25 24	15,49	178			
9 2891 25 06	114,18	181	9 4517 05	20,70	180	<b>W</b>		
9 2891 25 09	114,18	181	9 4517 25 01	20,70	180	WK696	1,28	192
9 3652 25 01	17,97	181	9 4517 25 05	20,70	180	WK697	1,47	192
9 3652 25 05	17,97	181	9 4517 25 07	20,70	180	WL0010	4,75	53
9 3652 25 07	17,97	181	9 4517 25 09	20,70	180	WL0012	5,99	53
9 3652 25 09	17,97	181	9 4519 05	10,75	180	WL0013	5,99	53
9 3652 25 10	17,97	181	9 4519 25 01	10,75	180	WL0020	6,13	53
9 3652 25 24	36,38	181	9 4519 25 02	10,75	180	WL0022	7,63	53
9 3652 25 68	36,38	181	9 4519 25 05	10,75	180	WL0023	7,63	53
9 3653 25 01	18,49	181	9 4519 25 06	10,75	180	WL0030	12,21	53
9 3653 25 05	18,49	181	9 4557 05	4,16	180	WL0032	15,23	53
9 3653 25 07	18,49	181	9 4557 25 05	3,06	180	WL0033	15,23	53
9 3653 25 09	18,49	181	9 4557 25 07	3,06	180	WL0040	8,07	54
9 3653 25 10	18,49	181	9 4557 25 09	4,16	180	WL0042	10,18	54
9 3653 25 24	40,78	181	9 4559 05	3,85	180	WL0043	10,18	54
9 3653 25 68	40,78	181	9 4559 25 05	3,85	180	WL0050	9,01	54
9 3655 25 01	18,44	181	9 4559 25 07	3,85	180	WL0052	11,25	54
9 3655 25 05	18,44	181	9 4559 25 09	3,85	180	WL0053	11,25	54
9 3655 25 07	18,44	181	9 4560 05	21,32	180	WL0060	13,54	53
9 3655 25 09	18,44	181	9 4560 25 01	21,32	180	WL0062	17,08	53
9 3655 25 10	18,44	181	9 4560 25 02	21,32	180	WL0063	17,08	53
9 3655 25 24	37,97	181	9 4560 25 05	21,32	180	WL0070	12,08	54

Referencia	Precio €	Pág. tarifa	Referencia	Precio €	Pág. tarifa	Referencia	Precio €	Pág. tarifa
WL0072	15,25	54	WL3123	31,32	57	WL7012	9,53	58
WL0073	15,25	54	WL3310	18,90	58	WL7013	9,53	58
WL0110	7,37	53	WL3312	23,85	58	WL7023	4,25	55
WL0112	9,20	53	WL3313	23,85	58	WL7030	7,35	58
WL0113	9,20	53	WL4010	61,70	58	WL7032	9,15	58
WL0210	5,50	53	WL4012	77,89	58	WL7033	9,15	58
WL0212	6,94	53	WL4013	77,89	58	WL8010	5,47	51
WL0213	6,94	53	WL4030	99,33	58	WL8020	8,48	51
WL0220	6,93	53	WL4032	123,79	58	WNA001	10,00	191
WL0222	8,75	53	WL4033	123,79	58	WNA001B	10,85	191
WL0223	8,75	53	WL5010	1,16	50	WNA002	21,68	191
WL0240	9,35	53	WL5120	2,09	50	WNA002B	22,23	191
WL0242	11,79	53	WL5130	3,36	50	WNA003	21,37	191
WL0243	11,79	53	WL5140	5,98	50	WNA003B	22,55	191
WL0310	19,72	54	WL5150	8,24	50	WNA006	22,91	191
WL0312	24,59	54	WL5220	2,09	50	WNA006B	23,59	191
WL0313	24,59	54	WL5230	3,36	50	WNA008	21,68	191
WL0320	20,14	54	WL5240	5,98	50	WNA008B	22,32	191
WL0322	25,42	54	WL5250	8,24	50	WNA009	59,84	191
WL0323	25,42	54	WL5310	1,29	59	WNA009B	60,91	191
WL0410	13,08	53	WL5312	1,64	59	WNA010	34,61	191
WL0412	16,49	53	WL5313	1,64	59	WNA010B	35,67	191
WL0413	16,49	53	WL5410	6,21	50	WNA020	13,83	191
WL0510	26,68	58	WL5420	4,42	50	WNA020B	14,18	191
WL0512	33,70	58	WL5510	1,25	51	WNA021	21,65	191
WL0513	33,70	58	WL5512	3,42	51	WNA021B	22,29	191
WL1040	8,80	55	WL5513	3,42	51	WNA022	18,02	191
WL1042	11,09	55	WL5620	2,31	51	WNA022B	18,66	191
WL1043	11,09	55	WL5622	6,26	51	WNA023	21,65	191
WL1060	5,11	55	WL5623	6,26	51	WNA023B	22,29	191
WL1062	6,30	55	WL5630	3,58	51	WNA025	28,92	191
WL1063	6,30	55	WL5632	9,71	51	WNA025B	29,92	191
WL1160	10,21	55	WL5633	9,71	51	WNA032	134,26	191
WL1162	12,89	55	WL5640	6,35	51	WNA033	109,29	191
WL1163	12,89	55	WL5642	17,24	51	WNA035	104,86	191
WL2010	12,26	56	WL5643	17,24	51	WNA036	122,02	191
WL2012	15,29	56	WL5650	8,88	51	WNA037	125,54	191
WL2013	15,29	56	WL5652	24,09	51	WNA037B	129,29	191
WL2020	22,37	56	WL5653	24,09	51	WNA038	20,68	192
WL2022	28,23	56	WL5720	2,31	51	WNA040	25,42	191
WL2023	28,23	56	WL5722	6,26	51	WNA040B	26,41	191
WL2110	18,54	56	WL5723	6,26	51	WNA041	38,55	191
WL2112	23,38	56	WL5730	3,58	51	WNA041B	40,53	191
WL2113	23,38	56	WL5732	9,71	51	WNA044	26,56	191
WL2120	37,06	56	WL5733	9,71	51	WNA044B	27,46	191
WL2122	46,78	56	WL5740	6,35	51	WNA045	41,97	191
WL2123	46,78	56	WL5742	17,24	51	WNA045B	43,45	191
WL2150	19,65	56	WL5743	17,24	51	WNA100	14,64	191
WL2152	22,83	56	WL5750	8,88	51	WNA155	23,63	191
WL2153	22,83	56	WL5752	24,09	51	WNA155B	24,37	191
WL2160	43,44	56	WL5753	24,09	51	WNA157	19,21	191
WL2162	54,86	56	WL5810	7,14	51	WNA157B	19,79	191
WL2163	54,86	56	WL5812	19,19	51	WNA161	14,77	191
WL2170	25,56	56	WL5813	19,19	51	WNA161B	15,20	191
WL2172	32,27	56	WL5820	10,87	51	WNA300	41,72	191
WL2173	32,27	56	WL5822	29,16	51	WNA300B	42,96	191
WL2180	52,40	56	WL5823	29,16	51	WNA301	39,09	191
WL2182	66,14	56	WL5830	16,30	51	WNA301B	44,41	191
WL2183	66,14	56	WL5832	43,73	51	WNA401	11,67	193
WL2210	23,04	56	WL5833	43,73	51	WNA401B	11,94	193
WL2212	29,09	56	WL6010	1,92	59	WNA402	16,59	193
WL2213	29,09	56	WL6012	2,44	59	WNA402B	16,44	193
WL2320	5,41	56	WL6013	2,44	59	WNA403	27,76	193
WL2322	6,84	56	WL6020	1,92	59	WNA403B	28,42	193
WL2323	6,84	56	WL6022	2,44	59	WNA408	16,59	193
WL2410	10,45	56	WL6023	2,44	59	WNA408B	16,44	193
WL2412	13,19	56	WL6030	1,92	59	WNA450	12,06	192
WL2413	13,19	56	WL6032	2,44	59	WNA455	20,68	192
WL2510	4,52	59	WL6033	2,44	59	WNA455B	21,30	192
WL2512	5,69	59	WL6110	2,11	59	WNA601	59,06	192
WL2513	5,69	59	WL6112	2,83	59	WNA602	59,06	192
WL3010	22,77	57	WL6113	2,83	59	WNA603	59,06	192
WL3012	28,76	57	WL6120	2,11	59	WNA681	4,82	193
WL3013	28,76	57	WL6122	2,83	59	WNA681B	5,16	193
WL3020	22,77	57	WL6123	2,83	59	WNA682	17,76	193
WL3022	28,76	57	WL6130	2,11	59	WNA682B	19,13	193
WL3023	28,76	57	WL6132	2,83	59	WNA683	27,32	193
WL3110	24,83	57	WL6133	2,83	59	WNA683B	28,15	193
WL3112	31,32	57	WL6320	5,43	57	WNA684	4,82	193
WL3113	31,32	57	WL6322	6,77	57	WNA685	17,76	193
WL3120	24,83	57	WL6323	6,77	57	WNA685B	19,13	193
WL3122	31,32	57	WL7010	7,64	58	WNA686	17,76	193

Referencia	Precio €	Pág. tarifa	Referencia	Precio €	Pág. tarifa	Referencia	Precio €	Pág. tarifa
WNA686B	19,13	193	WS606	2,55	192			
WNA689	1,46	193	WS607	34,44	192			
WNA690	2,31	193	WS608	2,55	192			
WNA690B	2,40	193	WS609	2,55	192			
WNA691	1,46	193	WUZ681	6,65	192			
WNA691B	1,56	193	WUZ682	6,65	192			
WNA693	11,83	193	WUZ686	6,65	192			
WNA694	3,11	193	WUZ687	6,65	192			
WNA695	48,30	192	WUZ690	8,86	192			
WNA696	48,30	192	WUZ691	7,38	192			
WNA697	49,68	192	WUZ692	6,07	192			
WNA698	49,68	192	WUZ695	10,32	192			
WNA699	80,05	192	WUZ696	9,60	192			
WNA700	14,04	193	WUZ697	6,07	192			
WNA710	84,10	192	WUZ698	7,38	192			
WNA711	86,45	192	WUZ699	7,38	192			
WNA712	86,45	192						
WNC001	13,35	190						
WNC001B	13,88	190						
WNC002	24,39	190						
WNC003	24,46	190						
WNC009	85,51	190						
WNC009B	86,53	190						
WNC020	16,01	190						
WNC021	23,89	190						
WNC022	20,00	190						
WNC023	23,89	190						
WNC025	27,26	190						
WNC032	126,91	190						
WNC033	96,62	190						
WNC035	133,61	190						
WNC036	171,56	190						
WNC040	28,17	190						
WNC041	36,69	190						
WNC044	31,02	190						
WNC155	25,33	190						
WNC155B	25,91	190						
WNC161	17,26	190						
WNC161B	18,30	190						
WNC164	39,94	190						
WNC165	59,90	190						
WNC174	39,94	190						
WNC455	20,70	190						
WNC455B	20,70	190						
WNE001	21,56	190						
WNE001B	21,89	190						
WNE023	31,87	190						
WNE023B	33,24	190						
WNE025	38,87	190						
WNE025B	39,40	190						
WNE040	32,71	190						
WNE040B	33,68	190						
WNE155	38,21	190						
WNE155B	39,59	190						
WNE161	24,82	190						
WNE161B	26,06	190						
WNT302	107,46	194						
WNT304	114,21	194						
WNT331	113,20	194						
WNT332	128,69	194						
WNT902	6,34	194						
WNT902B	6,97	194						
WNT912	7,60	194						
WNT912B	8,22	194						
WNT922	13,35	194						
WNT922B	13,40	194						
WNT932	7,60	194						
WNT932B	8,22	194						
WNT942	7,60	194						
WNT942B	8,22	194						
WNT944	9,10	194						
WNT944B	10,98	194						
WNT954	18,57	194						
WNT954B	18,74	194						
WNT964	8,84	194						
WNT964B	9,53	194						
WNT974	8,84	194						
WNT974B	9,53	194						
WNT982	8,84	194						
WNT982B	9,53	194						
WS604	2,55	192						
WS605	2,55	192						

El contenido y los precios de esta tarifa deben ser reflejo de los oficialmente vigentes salvo error u omisión involuntaria, que en tal caso se aplicarán los precios que estén oficialmente vigentes en el momento de la publicación de este documento.

**Nuevo producto, ref. en color azul**

Esta tarifa anula la anterior:

Tarifa 711 - Julio 2022  
(DC413aE22)

## 1. Objeto y ámbito de aplicación

- 1.1.- Al realizar un pedido, el cliente acepta plenamente y sin reservas las presentes Condiciones Generales, que prevalecerán sobre cualquier otro documento del cliente y, en particular, sobre cualesquiera otras condiciones generales, salvo expreso acuerdo previo en contra por escrito de HAGER SISTEMAS S.A.U. (en adelante, HAGER).
- 1.2.- Las presentes condiciones generales de venta se aplicarán a todas las ventas de productos por parte de HAGER.
- 1.3.- HAGER podrá otorgar por escrito condiciones especiales para el cliente cuando así lo justifiquen las circunstancias específicas de la operación.

## 2. Contratación - pedidos

- 2.1- Definiciones
  - 2.1.1- HAGER es una sociedad debidamente constituida con arreglo a la legislación española, con domicilio social en la calle Alfred Nobel, 18, Pol. Ind. Valldoríol, Apartado 39, E-08430 La Roca del Vallés (Barcelona, España).
  - 2.1.2- Se entenderá por "cliente" cualquier cliente profesional o empresarial que realice un pedido de compra de productos de HAGER.
  - 2.1.3- Se entenderá por "pedido" cualquier pedido de compra de productos de HAGER formulado por el cliente.
  - 2.1.4- Se entenderá por "contrato de venta" el contrato celebrado entre HAGER y sus clientes mediante la aceptación escrita por HAGER del pedido de compra formulado por el cliente.
- 2.2- Modificación del pedido
  - 2.2.1- Los pedidos recibidos y aceptados por HAGER serán irrevocables para el cliente, a menos que HAGER convenga otra cosa por escrito.
  - 2.2.2- El cliente deberá presentar una solicitud escrita para modificar la composición o el volumen del pedido. Para que surta efecto la modificación del pedido, HAGER deberá aceptar la petición por escrito (incluido correo electrónico o fax). El cliente reconoce expresamente que la aceptación de la solicitud de modificación del pedido podrá resultar del envío de los productos correspondientes al nuevo pedido.
  - 2.2.3- Si un cliente formula un pedido sin haber pagado previamente los pedidos anteriores, HAGER podrá negarse a atender los pedidos aceptados y a entregar los productos en cuestión sin ninguna clase de indemnización al cliente por ningún concepto.
- 2.3- Solvencia del cliente - pago en efectivo
 

La aceptación de los pedidos por HAGER está sujeta en todos los casos a que el cliente aporte garantías financieras suficientes con arreglo a la legislación aplicable.

Si HAGER considerase razonablemente que el cliente puede encontrarse en dificultades económicas en la fecha de formulación del pedido, podrá aceptar el pedido exclusivamente previo pago en efectivo o aportación de garantías a su favor por el cliente.

Antes de aceptar pedidos, HAGER podrá solicitar también al cliente que presente documentación contable, en particular su cuenta de resultados, aunque sean previsiones, con el fin de evaluar su solvencia.

HAGER podrá rechazar los pedidos cursados si el cliente se negara a pagar en efectivo sin proponer la prestación de garantías suficientes.

## 3. Entrega

- 3.1- Definición
 

La entrega se considerará producida en el momento del traspaso físico de los productos en las instalaciones o los almacenes del cliente.

En el caso de que el cliente se encargue del transporte de la mercancía, la entrega se considerará producida en el momento del traspaso físico al cliente, o al transportista designado por este, de los productos en las instalaciones o los almacenes de HAGER.

HAGER podrá realizar entregas completas o parciales. En caso de entrega parcial de un pedido, la parte no entregada no justificará la demora en el pago de la parte entregada.
- 3.2- Riesgos
 

Los términos de entrega, transporte y transmisión del riesgo de pérdida y/o daños de los Productos y los documentos se regirán por el Incoterm 2010 DAP, salvo que el cliente se encargue el transporte de la mercancía, en cuyo caso será de aplicación el Incoterm 2010 EXW.
- 3.3- Transporte por cuenta de HAGER
 

Los pedidos con un valor superior a 500€ se enviarán a portes pagados.

Los pedidos de importe inferior podrán viajar con porte a cargo de HAGER mediante recargo en factura del 5% sobre el valor neto del pedido, con un mínimo de 12€.

Dependiendo de las alternativas de envío disponibles, HAGER elegirá el modo de transporte más económico según su criterio.
- 3.4- Cantidades
 

Los materiales serán suministrados por embalajes completos conteniendo las cantidades indicadas en nuestras tarifas, excepto los indicados con el símbolo  con embalaje divisible.
- 3.5- Plazo de entrega
 

Los plazos de entrega se mencionan por parte de HAGER exclusivamente a título informativo e indicativo, y deberán ser considerados como una mera estimación, pues dependen principalmente, de la disponibilidad de los transportistas y del orden de llegada de materias primas y pedidos, que están fuera de control de HAGER. En todo caso, HAGER tratará de cumplir los plazos de entrega indicados al aceptar el pedido, según los plazos de entrega logísticos de referencia en el sector, y de atender los pedidos, excepto en caso de fuerza mayor, conforme a la definición de la cláusula 13, o circunstancias ajenas a su control.

Los plazos de entrega no son vinculantes para HAGER y, por tanto, en caso de demora en la entrega, HAGER no incurrirá en ninguna clase de incumplimiento ni ello dará lugar a ninguna penalización, compensación o indemnización de daños y perjuicios, ni justificará la cancelación del pedido formulado por el cliente y registrado por HAGER.

No serán vinculantes para HAGER las cláusulas de penalización por retraso que puedan aparecer en los documentos comerciales de los clientes.
- 3.6- HAGER se reserva el derecho de suspender las entregas en curso o futuras si una factura vencida de este u otro pedido, anterior o posterior, que no hubiera sido totalmente pagada y continuara impagada transcurridas cuarenta y ocho (48) horas desde el requerimiento formal de pago de la misma.

## 4. Recepción de la entrega - Comunicación de defectos aparentes y/o artículos no conformes y/o falta de artículos

- 4.1- Si los productos entregados tuvieran defectos aparentes o no fueran conformes, o si faltaran artículos respecto a los señalados en el pedido aceptado por HAGER, el cliente deberá manifestarlo y confirmar su reclamación por escrito (incluido correo electrónico, fax, requerimiento notarial y carta certificada con acuse de recibo) al transportista en el plazo de cuatro (4) días hábiles desde su recepción.
- 4.2- Sin perjuicio de las medidas a adoptar con respecto al transportista descritas en el apartado 4.1, en caso de defectos aparentes o falta de conformidad de los productos entregados o falta de algún artículo, HAGER sólo aceptará aquellas reclamaciones con respecto a los productos entre-gados que se realicen por escrito (incluidos correo electrónico, fax y carta certificada con acuse de recibo) en el plazo de cuatro (4) días hábiles anteriormente establecido en el citado apartado 4.1.
- 4.3- Los productos que no hayan sido objeto de reclamación en la forma y en los plazos anteriormente señalados, con envío simultáneo de copia de dicha reclamación a HAGER, se considerarán definitivamente aceptados por el cliente. El cliente no podrá adoptar ninguna otra medida al margen de las señaladas anteriormente para reclamar por defectos aparentes o falta de artículos.
- 4.4- El cliente tendrá la carga de probar la existencia de defectos o la falta de artículos. El cliente prestará a HAGER la asistencia necesaria para determinar la existencia de defectos y, en su caso, para subsanarlos.
- 4.5- El cliente no podrá devolver productos sin la previa y expresa aceptación de HAGER tanto respecto a la propia devolución como a sus términos económicos y operativos. La aceptación deberá obtenerse, en particular, por fax o correo electrónico.
- 4.6- HAGER sólo asumirá los gastos de devolución de los productos una vez que la propia HAGER o su agente autorizado concluyan que existe un defecto aparente o la falta de algún artículo.
- 4.6- Si tras la inspección, HAGER o su agente autorizado constataran efectivamente la existencia de

un defecto aparente o la falta de uno o más artículos, HAGER sustituirá los productos no conformes o aportará los que falten a su costa, sin que el cliente tenga derecho a indemnización alguna ni posibilidad de cancelar el pedido.

- 4.7- La aceptación en virtud de la recepción sin reclamación alguna por el cliente de la entrega de los productos encargados cubre todos los defectos aparentes y la falta de artículos. Cualquier reclamación deberá realizarse según las condiciones establecidas en la cláusula 4.2.
- 4.8- Las reclamaciones y requerimientos del cliente con arreglo a las condiciones y en los términos establecidos en esta cláusula 4 no suspenderán el pago de los productos en cuestión.
- 4.9- HAGER no asumirá ninguna responsabilidad por hechos acaecidos durante el transporte, como por ejemplo en caso de destrucción, averías, pérdida o robo, incluso en caso de que haya elegido al transportista.

## 5. Devoluciones de artículos sin defectos

- 5.1- Se aceptarán devoluciones de referencias publicadas en Tarifa PVP en vigor transcurrido un plazo inferior a 18 meses entre la fecha del albarán y la fecha de la devolución.
- 5.2- La devolución del material abonable sufrirá una depreciación del 15% en concepto de gestión.
- 5.3- Sólo se admitirán las devoluciones aceptadas previamente por HAGER. Para la aceptación de las mismas será necesario remitir el formulario HAGER de devolución (por correo electrónico, fax o carta certificada con acuse de recibo), firmado por el comercial de HAGER asignado, y autorizado por Dirección Comercial.
- 5.4- Sólo se admitirán devoluciones en embalajes completos, etiquetados y referenciados. Las devoluciones de productos de canalización se efectuarán sólo en embalajes completos, sobre palet si es más de un embalaje y con protección de film plástico sobre el mismo. Las devoluciones de armarios se harán sobre palet y con embalaje protector completo.
- 5.5- En caso de devolución por error en el pedido o por razones ajenas a HAGER, la mercancía y el embalaje de la misma deberán encontrarse en perfectas condiciones para su reventa y estar referenciada en la tarifa vigente. La mercancía será abonada a su valor neto, cargándose un demérito del 15% en concepto de participación en los costes de revisión y manipulado y descontándose, si ha lugar, otros costes derivados del mal estado de la misma.
- 5.6- En ningún caso se admitirán devoluciones de materiales que hayan sido utilizados, montados en otros equipos o instalaciones, o con evidencias de haber sido manipulados. Tampoco se admitirá la devolución de aquellos materiales en los que HAGER haya realizado alguna adaptación específica para el pedido.
- 5.7- Las devoluciones o envíos de material sin defectos a las instalaciones de HAGER, deberán efectuarse siempre por cuenta, riesgo y cargo del cliente.

## 6. Listas de precios - Precios

- 6.1- Listas de precios
 

6.1.1- Las listas de precios de HAGER son aplicables, según corresponda, a todos sus clientes en una determinada fecha, salvo estipulación en contrario en una negociación comercial entre HAGER y el cliente. Los precios de las listas podrán revisarse al alza durante el año, previa notificación a los clientes de HAGER. HAGER se reserva el derecho a establecer listas de precios diferenciadas en atención al destino final de los productos (venta física o venta en línea), sujeto a las limitaciones legalmente aplicables.

6.1.2- Los cambios de precios serán aplicables automáticamente en la fecha señalada en las nuevas listas de precios de HAGER.
- 6.2- Precios
 

6.2.1- Los precios aplicables son los establecidos en las listas de precios aplicables en la fecha de solicitud del pedido.

6.2.2- Los precios no incluyen el IVA, aranceles u otros impuestos aplicables a los productos o relativos a la operación de venta ni los costes de la entrega, según se define en la cláusula 3. Los precios incluyen el coste del empaquetado, excepto en el caso de empaquetados especiales. Salvo pacto en contrario, HAGER selecciona y prepara el empaquetado y no lo recoge de vuelta.

6.2.3- El importe mínimo de pedido es de cien euros (100€), IVA no incluido.

## 7. Condiciones de pago

- 7.1- Pago
  - 7.1.1- A menos que HAGER y el cliente acuerden otra cosa como resultado de una negociación comercial, las facturas de HAGER se pagarán en el plazo de cuarenta y cinco (45) días naturales desde la fecha de recepción de los productos. La factura indicará expresamente la fecha de pago. El precio se pagará de la forma siguiente, quedando excluida cualquier otra forma de pago:
    - cheque a la recepción de la factura,
    - letra de cambio electrónica aceptada (LCRA),
    - débito directo o
    - transferencia.

En caso de pago mediante letra de cambio electrónica, el cliente deberá devolverla aceptada y firmada en un plazo máximo de quince (15) días naturales desde la fecha de facturación.

A los efectos de estas condiciones generales de venta, se entenderá por pago el cobro efectivo del instrumento en la fecha de vencimiento, no la mera entrega de un cheque o una letra de cambio electrónica (LCRA).

7.1.2- El pago no podrá suspenderse, o demorarse, ni compensarse sin la previa autorización escrita de HAGER.

7.2- Demora en el pago e impago
 
    - 7.2.1- En caso de demora en el pago, HAGER podrá suspender todos los pedidos del cliente en curso, sin perjuicio del sometimiento de la cuestión a los tribunales competentes.
    - 7.2.2- Las cantidades impagadas a su vencimiento devengarán intereses al tipo aplicado por el Banco Central Europeo (BCE) en su operación de refinanciación más reciente, más diez (10) puntos porcentuales. El tipo aplicable durante la primera mitad de un determinado año será el tipo del BCE aplicable el 1 de enero de ese año, y el de la segunda mitad del año será el aplicable el 1 de julio. Conforme a lo establecido en el artículo 5 de la Ley 3/2004, de 29 de diciembre, por la que se establecen medidas de lucha contra la morosidad en las operaciones comerciales, los intereses se devengarán automáticamente sin necesidad de aviso de vencimiento ni intimación alguna por parte de HAGER.
    - 7.2.3- El incumplimiento total o parcial de las obligaciones de pago del cliente o la demora en su cumplimiento conllevarán un cargo de 40€, sin perjuicio de la indemnización que pueda corresponderle a HAGER por cualesquiera otros perjuicios sufridos.
    - 7.2.4- Si no se realizara el pago en el plazo de setenta y dos (72) horas desde la recepción de un requerimiento formal de pago (la fecha de recepción será la que aparezca en el acuse de recibo postal, en su caso), HAGER podrá cancelar la venta sin necesidad de iniciar ningún procedimiento judicial a tal efecto.

A elección de HAGER, la cancelación realizada en virtud de la presente cláusula no sólo será aplicable al pedido en cuestión, sino a todos los pedidos anteriores del cliente, con independencia de que hayan sido o no entregados, se encuentren en curso de entrega o se hallen impagados o no. En tal caso, el cliente deberá devolver a HAGER inmediatamente, a su propia cuenta y riesgo, los productos entregados que no hayan sido pagados en su totalidad y correspondan a los pedidos cancelados. La cancelación en los términos anteriormente establecidos operará sin perjuicio de cualquier otro derecho, en particular el de reclamar los daños y perjuicios sufridos por HAGER.

7.2.5- El impago de una sola factura a su vencimiento dará lugar, a elección de HAGER, al vencimiento inmediato de todas las cantidades adeudadas.

## 8. Reserva de dinero

- 8.1- HAGER conservará la propiedad de los productos hasta el pago total de su precio por el cliente, incluido el principal y los intereses y gastos accesorios, incluso cuando se amplie el plazo de pago. Cualquier cláusula en contrario, en particular las que puedan incluirse en condiciones generales de compra, se tendrá por no puesta.
- 8.2- El cliente deberá mantener los productos en perfecto estado y asegurarlos frente a los riesgos habituales, en particular los de pérdida, destrucción y robo. En caso de daños, cualquier posible indemnización se transferirá a HAGER. El cliente deberá comunicar inmediatamente a HAGER cualquier siniestro o reclamación.

8.3- El cliente deberá informar inmediatamente a HAGER en caso de administración judicial, liquidación u otra medida por insolvencia, así como en caso de embargo u otra actuación de terceros sobre los productos, indicando a HAGER los lugares exactos de almacenamiento de los productos entregados y aún no pagados. El cliente no podrá utilizar en modo alguno los productos entregados y aún no pagados como garantía y, en general, se abstendrá de realizar cualquier operación que pueda perjudicar la propiedad de HAGER.

8.4- En caso de acuerdo expreso, HAGER podrá ejercitar los derechos reconocidos en esta cláusula sobre cualesquiera de sus créditos o productos que se hallen en poder del cliente (respecto a los cuales se presumirá que son productos cuyo precio está total o parcialmente impagado).

A tal efecto, HAGER podrá recuperarlos como compensación por todas las facturas pendientes, sin perjuicio de su derecho a cancelar las ventas en curso.

8.5- El cliente sólo podrá revender los productos de HAGER cuyo precio esté total o parcialmente impagado en el marco del funcionamiento ordinario de su negocio y no podrá en ningún caso ignorarlos o constituirlos en garantía, ni transferir su propiedad en virtud de cualquier clase de garantía.

8.6- Hasta el momento en que reciba el pago total de cualquier factura impagada, HAGER podrá exigir también la cancelación de la venta mediante el envío de un simple requerimiento formal. Del mismo modo, HAGER podrá, tras el envío de un requerimiento formal, realizar o disponer que se realice unilateralmente un inventario de los productos que se hallen en poder del cliente, quien se compromete expresamente a permitir el libre acceso a sus almacenes, tiendas u otras instalaciones a tal efecto, así como a garantizar en todo momento la posibilidad de identificar los productos de HAGER.

8.7- HAGER se reserva el derecho a reclamar los productos en stock. Esta cláusula no impedirá la transmisión del riesgo por la adquisición de los productos al cliente en el momento de la entrega (cláusula 3). El cliente se considerará un depositario de los productos desde el momento de la entrega.

#### 9. Descuento por pronto pago

HAGER podrá conceder, si así se ha negociado, un descuento al cliente si este efectúa el pago correspondiente antes de la fecha resultante de la aplicación de las condiciones generales de venta (es decir, en menos de treinta (30) días naturales desde la fecha de recepción de los productos) o realiza el pago en efectivo. Las condiciones y términos específicos se establecerán con el cliente.

#### 10. Garantía por vicios o defectos ocultos

10.1- HAGER garantiza que los productos que vende están libres de vicios o defectos de diseño, materiales y fabricación durante un período de dos (2) años desde la fecha de fabricación marcada en el producto.

10.2- La garantía por vicios o defectos ocultos definida en el apartado 10.1 es independiente de la garantía prestada por HAGER por defectos aparentes, falta de conformidad o falta de artículos, que el cliente sólo puede disfrutar con sujeción al cumplimiento de los plazos, condiciones y términos definidos en la cláusula 4 de estas condiciones generales de venta. La garantía por vicios o defectos ocultos se aplica con las excepciones y limitaciones establecidas en la cláusula 11 de las presentes condiciones generales.

10.3- Dado que los clientes de HAGER son clientes profesionales o empresas, los vicios o defectos ocultos incluyen los defectos de fabricación del producto que lo hagan inadecuado para su uso normal y no sean detectables por el cliente en el momento de la entrega.

10.4- En virtud de esta garantía, HAGER podrá optar entre la devolución al cliente del precio de venta del producto no conforme o la sustitución de la pieza o el producto defectuosos. Cualquier otra reparación, compensación o indemnización de cualquier clase y por cualquier motivo queda excluida.

10.5- Para que sean tomados en consideración, los productos no conformes cubiertos por la garantía deberán devolverse a HAGER, previa aceptación por ésta mediante la firma de un documento de devolución de HAGER.

10.6- Las devoluciones de productos señaladas en esta cláusula se realizarán siempre a costa y riesgo del cliente.

10.7- La responsabilidad de HAGER está estrictamente limitada a las obligaciones expresamente estipuladas en estas condiciones generales. Queda expresamente excluida cualquier otra garantía, ya sea de naturaleza legal, expresa o implícita, incluidas, entre otras, las garantías expresas o implícitas de comerciabilidad o idoneidad para un determinado fin.

#### 11. Exclusiones de la garantía

11.1- Quedan excluidas de la garantía establecida en la cláusula 10 de estas condiciones generales de venta todas las piezas y consumibles que devengan inoperativos a causa del desgaste ordinario por el uso (incluidas, entre otras, las pilas o baterías, sean o no recargables).

11.2- HAGER no responderá de los defectos y daños causados por condiciones anormales de almacenamiento o conservación en las instalaciones del cliente, en particular los debidos a cualquier clase de accidente.

11.3- HAGER no responderá tampoco de los defectos y daños causados por el desgaste ordinario debido al uso, accidentes externos, negligencia, actos maliciosos, utilización en condiciones extremas (incluidos, entre otros, los ambientes húmedos, ácidos o polvorientos, las temperaturas elevadas, las emanaciones químicas, etc.), el uso anormal o defectuoso de los productos o el incumplimiento de las instrucciones de uso de HAGER.

11.4- No será de aplicación ninguna garantía a los incidentes debidos acaso fortuito o fuerza mayor.

#### 12. Derechos de propiedad intelectual y confidencialidad

12.1- HAGER es el titular de todos los derechos de propiedad intelectual e industrial sobre sus proyectos, estudios y documentos de toda clase. Esta información no podrá revelarse o aplicarse sin la autorización por escrito de HAGER.

12.2- En caso de revelación, la información deberá devolverse a HAGER a primer requerimiento.

12.3- La tecnología y el know-how incorporados a los productos, estén o no patentados, y todos los derechos de propiedad intelectual e industrial relativos a los productos continuarán siendo propiedad exclusiva de HAGER.

#### 13. Fuerza mayor

13.1- A los efectos de estas condiciones generales de venta, se entenderán por caso fortuito o fuerza mayor aquellos acontecimientos que se hallen fuera del control de las partes y no pudieran haber sido razonablemente previstos, evitados o superados, en la medida en que su producción impida a las partes cumplir sus obligaciones.

13.2- Se considerarán como supuestos de caso fortuito o fuerza mayor, a título meramente ejemplificativo, los de huelga de empleados y de los transportistas habituales, incendio, inundación, guerra, interrupciones de la producción por averías accidentales, imposibilidad de aprovisionamiento de materias primas, epidemia, pandemias, restricciones sanitarias que afecten al normal funcionamiento de la actividad económica, escasez extraordinaria o ausencia generalizada de mano de obra, materiales u otros recursos generalmente disponibles, límites de peso en carreteras por deshielo, bloqueos de carreteras, huelgas y cortes de gas o electricidad, interrupciones en el aprovisionamiento de los proveedores y restricciones a la actividad impuestas de los gobiernos, Estados o autoridades competentes y siempre que estén relacionadas con las anteriores circunstancias, tales como estados de alarma, excepción o sitio. En caso de producirse alguna de estas circunstancias, HAGER estará expresamente autorizada a no cumplir su obligación de entrega de los productos en los plazos, indicados a título informativo e indicativo, inicialmente programados.

13.3- En estos supuestos, HAGER deberá comunicar por escrito al cliente, en particular por fax o correo electrónico, en el plazo de setenta y dos (72) horas desde la fecha de producción del acontecimiento, que el acuerdo entre HAGER y el cliente queda suspendido desde la fecha de producción del acontecimiento, excluyéndose el derecho a reclamar ninguna clase de indemnización.

13.4- Si la circunstancia de fuerza mayor o caso fortuito se prolongara durante más de treinta (30) días naturales desde la fecha de su producción, tanto HAGER como el cliente podrán cancelar el contrato de venta, sin derecho para ninguna de las dos partes a reclamar ninguna clase de indemnización o compensación de cualquier naturaleza.

13.5- La cancelación surtirá efecto desde la fecha del acuse de recibo de la carta certificada por la que se resuelve el citado contrato.

#### 14. Cesión

14.1- El cliente no podrá ceder, gravar, transferir o disponer de otro modo, total o parcialmente, de los derechos y obligaciones derivados del contrato de venta sin la previa autorización por escrito de HAGER.

#### 15. Ley aplicable y jurisdicción competente

15.1- Cualquier conflicto que pudiera surgir en relación con las condiciones generales de venta de HAGER o el contrato de venta celebrado entre HAGER y el cliente, incluidos los relativos a su validez, interpretación, cumplimiento y ejecución, quedan sometidos a los juzgados y tribunales de Barcelona (España).

15.2- Todos los conflictos relacionados con estas condiciones generales de venta o con el contrato de venta, incluidos los relativos a su validez, interpretación, cumplimiento y ejecución, se regirán e interpretarán por las leyes españolas, excluidos los Derechos Forales.

15.3- Serán de cuenta del cliente todos los costes de las actuaciones judiciales y extrajudiciales realizadas por HAGER para cobrar las deudas y exigir el pago del pedido en cuestión. Asimismo, todos los gastos relacionados serán de cuenta del cliente que hubiera incurrido en incumplimiento (incluidos, entre otros, los costes de notificación o demanda formal, las costas judiciales y los honorarios de abogados y procuradores).

#### 16. MISCELÁNEA

16.1- Traducción. Las presentes condiciones están también disponibles en inglés. En caso de conflicto o contradicción entre ambas versiones, prevalecerá la versión en inglés.

16.2- Divisibilidad. Si alguna cláusula de estas condiciones generales de venta o del contrato de venta, incluidas las limitaciones de garantía y responsabilidad, fuera considerada nula, ineficaz o inaplicable por una autoridad judicial o administrativa, ello no afectará a las restantes cláusulas, que conservarán plena vigencia y eficacia.

16.3- Renuncia. La falta de ejercicio por HAGER de cualquier derecho conferido por las presentes condiciones generales de venta no se considerará como una renuncia al mismo, ni operará de manera que obstaculice el ejercicio de tales derechos en cualquier momento posterior.

16.4- Riesgos de salud y seguridad de los productos. El cliente se compromete a implementar las actuaciones y medidas aplicadas por HAGER para evitar los riesgos que puedan presentar los productos, incluida su retirada del mercado, la adecuada y efectiva advertencia a los consumidores y la retirada de los productos comercializados que se hallen en poder de los consumidores.

16.5- Modificación de los productos. HAGER se reserva el derecho a realizar en cualquier momento los cambios que considere necesarios en sus productos y, sin que ello conlleve la obligación de cambiar los productos ya entregados o en proceso de entrega, a modificar, sin previa notificación, los modelos definidos en sus folletos, catálogos y, en general, en cualquier documento comercial o publicitario.

# Delegaciones

## España



- Oficina Delegación
- Oficina Subdelegación
- Agentes desplazados

### Delegación Nordeste

□ Montsià 6  
Poligon Can Bernades  
08130 Santa Perpètua de Mogoda  
(Barcelona)  
Teléfono 938 467 622

Baleares:  
Teléfono 666 594 593

### Delegación Levante

□ Edificio Albufera  
Plaza de la Alqueria de Culla 4  
4ª planta - Oficina 408  
46910 Alfafar (Valencia)  
Teléfono 961 225 292

### Delegación Sur

□ Paseo Cerrado de Calderón 13  
Edif. Multicentro, local 25  
29018 Málaga  
Teléfono 952 200 021

○ Parque Empresarial  
Nuevo Torneo  
Astronomía s/n  
torre nº 4 - planta 8ª - oficina 12  
41015 Sevilla  
Teléfono 952 200 021

Canarias:  
Teléfono 610 299 845

### Delegación Centro

□ Calle Alcalá 265  
Edificio 2, planta 3 oficina 1  
28027 Madrid  
Teléfono 913 410 270

Toledo, Ciudad Real, Ávila  
y Extremadura  
Teléfono 913 410 270

Murcia:  
Teléfono 670 730 315

### Delegación Noroeste

□ Avda. Conde de  
Guadalhorce 43  
2º Oficina B  
33401 Avilés (Asturias)  
Teléfono 985 525 466

○ Calle Padre Feijoo 1  
Bajo derecha  
15679 O Temple (Cambre)  
(A Coruña)  
Teléfono 985 525 466

### Delegación Norte

□ Miquel Roca i Junyent 7  
Estación Central de  
Autobuses, Of. 109  
50011 Zaragoza  
Teléfono 976 535 196

○ Estarteche 5  
1º - Oficina 4  
48940 Leioa (Bizkaia)  
Teléfono 985 525 466

## Contacte con nosotros:

### Nº Telf. :

Ver teléfonos de contacto  
para cada zona, en esta  
página.

### Web :

[hager.es/asistencia-tecnica](http://hager.es/asistencia-tecnica)



**Hager Sistemas S.A.U.**

Alfred Nobel 18  
Pol. Ind. Valldoríol  
Apartado 39  
E-08430 La Roca del Vallès

Teléfono 938 424 730  
[hager.com/es](http://hager.com/es)



[hager.es/tarifas](http://hager.es/tarifas)

DC338kE23