

Tertiary buildings
h3+ moulded cases

Guaranteed protection



:hager

Premium performance

Energy efficiency lies at the heart of present and future building construction. Energy performance relies on the quality of the networks transmitting the energy: sizing, maintenance and monitoring. And to guarantee maximum reliability in electrical installations, low voltage panels must incorporate solutions renowned for their simplicity and efficiency.



44 %
of energy consumption
in France is accounted
for by buildings.

Energy is also believed to make up 40 % of the costs generated throughout a building's life cycle. Faced with the inevitable rise in energy costs, the challenge is clear: manage consumption to bring down bills. Creating intelligent buildings means optimising and streamlining their consumption based on usage.

Hager's h3+ anticipates and incorporates the standards governing energy distribution in tertiary buildings.

The new IEC 60 364 standard states that energy must be used as efficiently as possible. It also highlights the importance of adopting an energy efficiency approach right from the building design stage, on a par with safety and commissioning rules. It classifies energy performance in new buildings on five levels. The IEC 60 364 standard includes recommendations and a continuous improvement methodology, along with verification steps for the results obtained. It also requires an electrical energy management system to be integrated in the installation. The system must be able to manage various energy sources, monitor energy usage and take account of usage habits within the building. The standard focuses on three points: minimising energy loss, using energy at the right time and at the lowest cost, and maintaining an optimal level of availability and performance.

The Hager solution also addresses buildings involved in the ISO 50001 certification process, which involves the creation of an energy consumption improvement plan. It responds to the applicable decree aimed at reducing energy consumption in existing buildings.

The new generation of Hager h3+ moulded case circuit breakers guarantees reliable protection against overloads and short circuits, as well as targeted, integrated energy monitoring for all low voltage distribution systems.



Performance
Service continuity
Energy management



h3+, the moulded case circuit breaker

Your installation is under control

The size of tertiary buildings determines the energy requirements. Regulations are becoming increasingly strict. You therefore need effective protection suited to your electrical installation.

The new h3+ moulded case circuit breakers meet these requirements, thanks largely to their breaking capacity of up to 110 kA. As its name implies, the h3+ range offers a broader choice, with seven trip units, more smart features, and more reliable protection. Advanced technology for optimal safety.

One range. Three versions

The choice is yours

From the traditional version to the intelligent connected model: discover the multi-faceted range of h3+ circuit breakers.

Featuring the compact frame sizes, available from 25 to 630 A with 3 or 4 poles, the h3+ provides superior protection and a breaking capacity up to 110kA.

Equipped with a thermal magnetic or electronic trip unit, the moulded case circuit breaker range offers an accurate benefit: flexible protection settings for all electrical distribution applications.



NEW
h3+/P160
208 variants



NEW
h3+/P250
254 variants



NEW
h3+/P630
78 variants

The new generation of h3+ moulded case circuit breakers is available in two versions: the traditional range for protecting your electrical installations and the energy model for improving the energy efficiency of your buildings.



Multi-site
The new h3+ moulded case circuit breakers are ideal for all types of tertiary buildings, including shops, hotels, offices and healthcare establishments.

01 Traditional version

Protect



02 Energy version

Protect
Measure, meter
Display
Communicate

agardio.measure

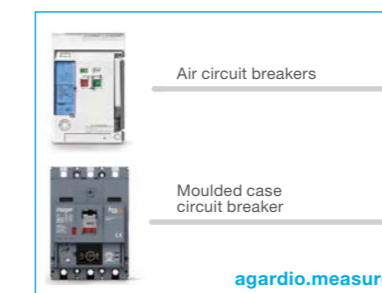
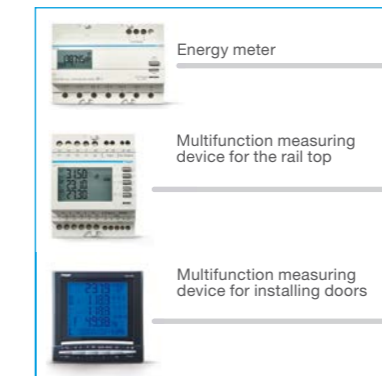

agardio.manager

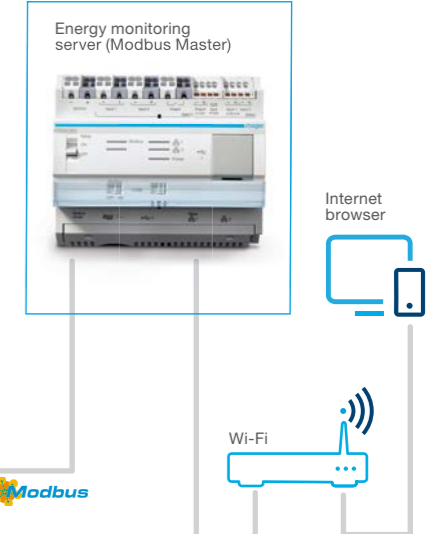

From the circuit breaker to the communication panel, built-in solutions are at the heart of the h3+ offering.

Guaranteed protection

The new range of moulded case circuit breakers provides solutions suitable for electrical installations in commercial buildings. It offers reliable protection against overloads and short circuits.

The multiple setting options, created by coordinating the protection systems, offer the best possible combinations. This brings a threefold benefit: guaranteeing user and equipment safety under all conditions, ensuring continuity of service and availability of energy in normal operating situations, and, in case of transient faults, reducing the risks to the installation's components.

All products in the new range can be easily integrated in the hager enclosure systems.



- Most compact product on the market with measurement and communication.
- From 25 to 630 A
- Three frame sizes
- Can be mounted on the DIN rail in option up to 250 A
- TM, MAG, LSnl, LSI, LSIG and Energy trip units
- Breaking capacity of 25, 40, 50, 70 and 110 kA at 415 VAC
- 3P3D or 4P4D (neutral adjustable to 0, 50 or 100 %)
- Wide range of auxiliaries and accessories
- Horizontal or vertical installation



01 Secure screw

The quarter-turn auxiliary access system saves time when installing the product. The secure screw offers additional comfort.



02 Hinged front cover

The front cover offers multiple advantages. It is mounted on hinges. It remains integral with the case once opened, preventing incorrect refitting.



03 Auxiliary window

The type of auxiliaries can be seen directly through the windows on the front panel, without removing the cover.



04 Integrated padlock

The handle can be directly locked with no need for extra accessories.



All the technical specifications are available in the technical repository and the network calculation software, hagercad.net.

In addition to the traditional version: h3+ energy version

In intelligent and connected mode

Hager is complying with energy efficiency standards by adding new functions to its moulded case circuit breaker range. A Class 1 energy monitoring and communication system compatible with the Modbus RTU protocol can be used to configure the protection parameters, monitor energy consumption and manage alarms.

Energy performance

The h3+ moulded case can be coupled with the agardio.manager multi-energy manager, allowing it to be integrated in an energy efficiency environment.

This allows the energy consumption to be displayed centrally, while complying with the IEC 60364, NF 15-100 and ISO 50 001 standards. Class 1 measurement accuracy is guaranteed.

Service continuity

A specific auxiliary is used to trigger a fault alarm. This function helps prevent a total power outage. The user is notified in advance, allowing the appropriate action to be taken.

Secure connection

The functions are pre-wired to connectors. The bus connection uses an RJ45 connector, which means there is no risk of incorrect wiring. The power is supplied from the tool and no external source is required.



- 05 Integrated pre-alarm contact
- 06 OLED screen
- 07 Configurable alarm contact
- 08 Communication port

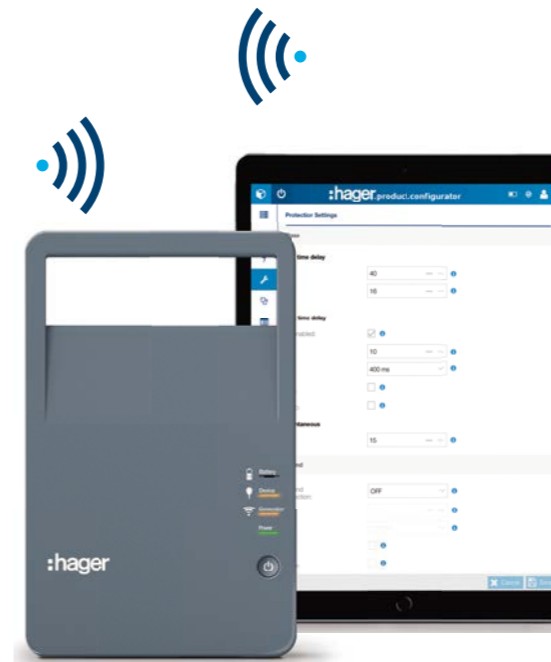

Greater flexibility

The moulded case circuit breaker can be configured via the built-in screen, the panel display or the configuration tool. In the latter case, the interface used for configuration does not need to be installed since the software operates via the Webserver on your phone, tablet or PC.

Greater ease of use

Cut programming times for your installation by up to 80 % with the agardio.manager ecosystem. Pre-addressing is already done: a library of products is available in agardio.manager. There is therefore no need to complete the addressing table: you need only name the products.



Overview

- Over 300 variants
- Intelligent electronic tripping
- Breaking capacity up to 110 kA
- Intelligent programming (h3+ energy only)



hager.fr/h3+

- Variants
- Trip units
- Tutorials
- Configuration
- Energy monitoring
- Auxiliary switch
- FAQ
- Hager recommendation

h3+ energy go further

Measure, meter, communicate: the h3+ energy version can be integrated in the agardio.manager ecosystem, the solution designed by Hager to monitor and manage energy consumption.



Associated with the agardio.manager ecosystem, the h3+ energy range is at the forefront of a new generation of circuit breakers that combine safety and energy efficiency.



It guarantees Class 1 energy measuring accuracy.

You can use your smartphone, tablet or PC to easily access information on the use and maintenance of the building. Consumption and installation configuration data, alarms and faults can be identified at any time. The h3+ energy moulded case is a scalable solution that protects, measures, meters, displays and communicates.

The h3+ energy moulded case is an adaptable, scalable solution that protects, measures, meters, displays and communicates.



For bakeries, hotels and residential care homes: you are immediately warned if there is a power outage, enabling you to maintain the cold chain and preserve the quality and comfort of living areas.

The agardio.manager ecosystem: three in one

01 Measure and meter

The device collects field-based information on the network and protection.



02 Centralise

The agardio.manager centralises and feeds back information. This is the heart of the installation.

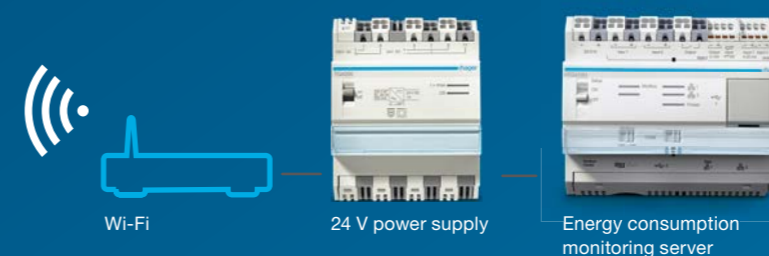

The agardio.manager is a multi-site manager that records, displays and monitors the network quality and energy consumption parameters. It guarantees compliance with the new IEC 60 364 and ISO 50 001 standards.

03 Display and monitor

The Webserver interface manages the entire system. It provides structured data.



Integrated web server, easy display in real time or for a defined period.

Access via internet browser



A needs-based approach

TM

h3+ circuit breakers equipped with magnetothermal trip units are designed for power distribution applications. They are used to protect the conductors and the loads supplied by the transformers or generators, and when the fault current is limited due to impedance caused by the length of the conductors. The settings are made using adjustment dials on the front of the products.

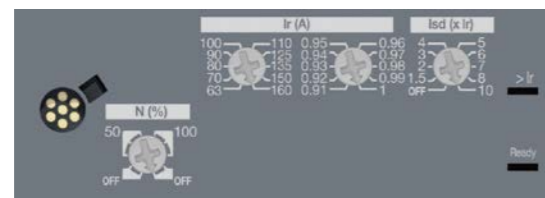
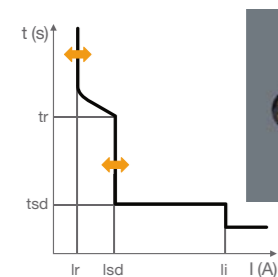
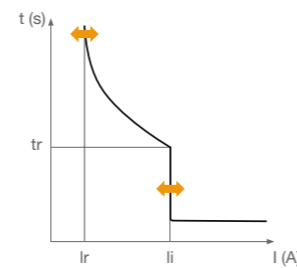
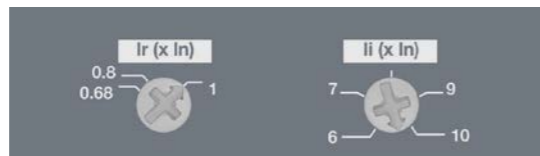

LSnl trip unit

Designed to protect networks supplied by transformers or generators and for long cables, the LSnI version offers a solution adapted to this type of supply.

LSI and LSIg trip units

h3+ circuit breakers equipped with LSI or LSIg trip units are designed for power distribution applications for protecting conductors and loads in cases where a wide range of protection settings is required.

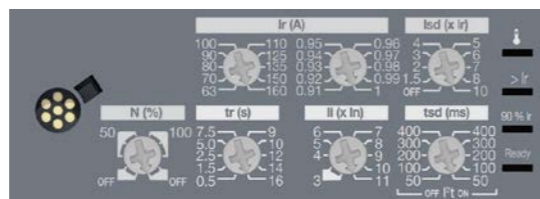

Settings made using adjustment dials are accessible on the front of the products, and enable accurate adjustment of the protection and a trip curve independent of the ambient temperature. The LSIg version offers a protection against the ground fault.

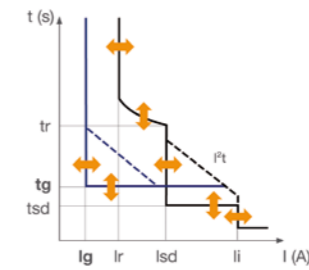
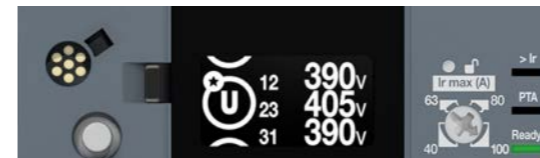
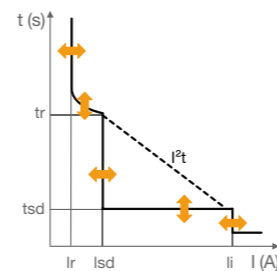

Energy trip unit

Offering a similar protection than LSIg trip unit, the Energy benefits from a class 1 energy monitoring and communication system compatible with Modbus RTU protocol that will allow them to configure protections parameters, monitor energy consumptions and manage alarms.

MAG (ICB)

h3+ circuit breakers equipped with magnetic trip units are designed for use in power distribution applications in which only magnetic protection is required. They are mainly used to protect motors associated with a thermal relay and a power switch.

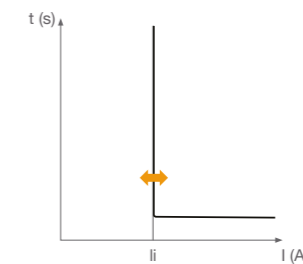

TM, MAG, LSnI, LSI, LSIg, Energy: six trip unit versions designed to effectively protect your installations and optimize the cost of your switchboards.

	TM		MAG		LSnI		LSI		LSIg			Energy			
	P160	P250	P160	P250	P160	P250	P160	P250	P630	P250	P630	P160	P250	P630	
Breaking capacity	25,40, 50 or 70kA		25,40, 50 or 70kA		25, 40, 50 or 70kA		25, 40, 50 or 70kA		40, 50, 70, 110 kA	25, 40, 50, 70 kA	40, 50, 70, 110 kA	25, 40, 50 or 70kA			
Ratings	25 - 160 A	50 - 250 A	25 - 160 A	100 - 250 A	40 - 160 A	40 - 250 A	40 - 160 A	40 - 250 A	250 - 630 A	40, 100, 160, 250 A	250 - 630 A	40 - 160 A	40 - 250 A	250 - 630 A	
No. of poles (P) and trip units (D)	3P3D or 4P4D (N: 0 -100% or 0 - 50%)		3P3D or 4P4D		3P3D or 4P4D (N: 0, 50 or 100%)		3P3D or 4P4D (N: 0, 50 or 100%)		3P3D or 4P4D (N: 0, 50 or 100%)			3P3D or 4P4D (N: 0, 50 or 100%)			
RCD add-on block	No	Yes	No	Yes	No	Yes	No	Yes	Yes	Yes	Yes	No	Yes	Yes	
Configuration tool													Yes		
Panel display													Yes		
Communicating version													Yes		



easy to install

Designed for professionals, the h3+ moulded case circuit breaker range is without doubt the best adapted to installation requirements. Compact and ergonomic, the h3+ is particularly easy to integrate in switchboards. Easy commissioning, fast wiring: everything to optimise installation.

Horizontal or vertical installation

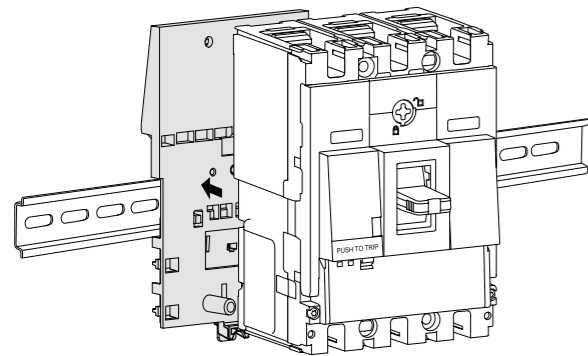

Mounting

P160 and P250 can be mounted on DIN rail

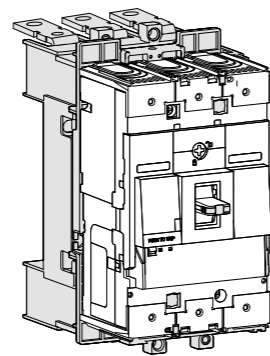

Plug-in

Available for frame P160 and P160, P250 and P630

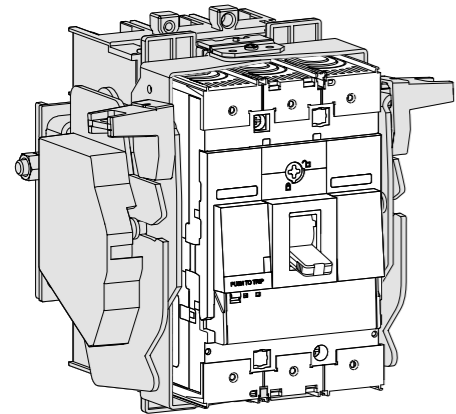

Withdrawable

Available for frame P250 and P630

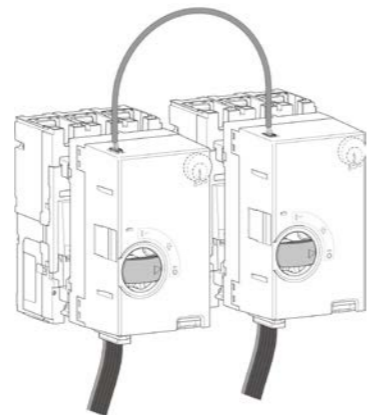

Interlocking

Available for frame P160, P250, P630

1. RCD add-on block

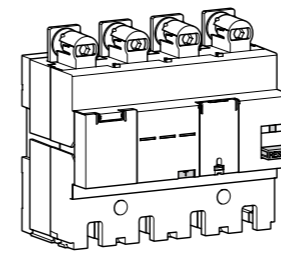

2. Connection accessories

Connection terminals

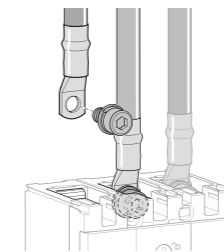

External terminals

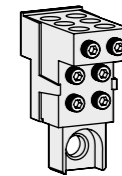

Rear connections

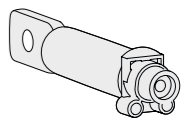

3. Terminal enclosures

For extended connections

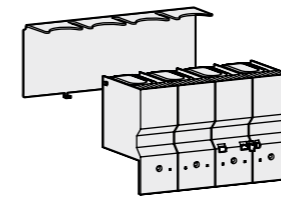

For spreaded connections

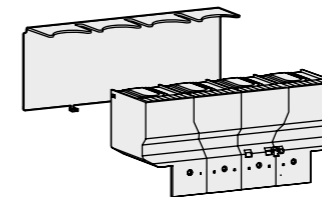

For rear connections

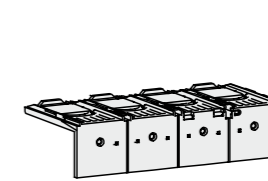

4. Auxiliary contacts

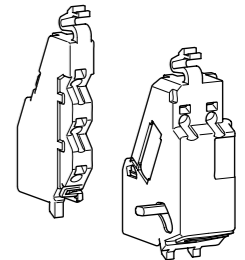

5. Control auxiliaries

Direct rotary operation

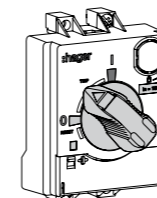

External rotary operation

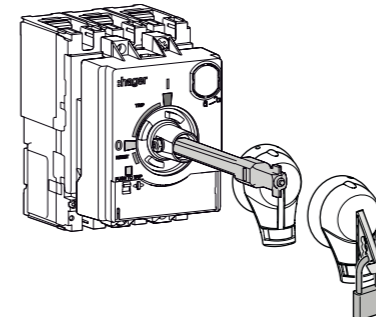

Motor operator

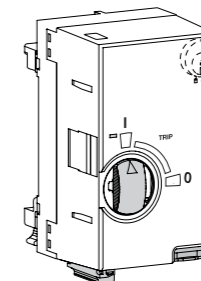

6. Locking device

Padlocking device

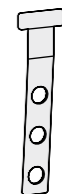

Ronis type key device



Pro-business solutions provider

Hager offers solutions tailored to your business and your requirements. Ranges designed to meet your working requirements: ease, speed, peace of mind.



Panel builders

Install and monitor your cabinet quickly and with complete peace of mind.

Advantages:

- Time savings thanks to the front cover
- Quick connection
- Easy adjustment

Installers

With easy configuration, connection and setting, and quick case commissioning, the h3+ range saves you a lot of time.

Advantages:

- Quick commissioning
- Flexible configuration



Design office

Manage your consumption with agardio.manager. You are kept informed of service continuity and benefit from a scalable solution adapted to the normative environment.

Advantages:

- Energy optimisation
- Service continuity



Integrators

The agardio ecosystem enables you to optimise the integration and commissioning of the solution.

Advantages:

- Quick, secure connection
- Cut your installation programming time by up to 80 %

Hager.

A partner made for you.*



Business and Living Space Management

Cable Management / Room Solutions

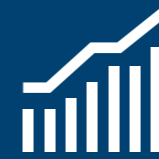

Energy Management

Energy Management



Electrical Infrastructure

Energy Distribution

As an expert partner for electrical building infrastructure with strong expertise in integrated room solutions, efficient energy distribution and energy management solutions as well as cable management solutions, we listen closely to understand your special needs. We advise and deliver on solutions and services tailored to your individual requirements.

From hotels to offices and retail – we make tomorrow's commercial life and business places happen.

*Hager. A partner for your tertiary projects

Hager Training, the path to excellence



Take steps to develop your skills

Votre accès
formation facilité

Pass
compétences
entreprise

:hager

Benefit from three 7-hour training sessions for one or more of your employees.

- €720 incl. tax (2018 prices)
 - Valid for one calendar year
 - Breakfast included
 - Accommodation and travel costs not included.
- Easy access to training
hager.fr/pass

Technical assistance, get answers quickly

Access any information you
require in a few clicks.



Manuals

Installation,
product wiring



Videos

For commissioning
a product



Tutorials

Recommendations,
configuration,
settings, etc.

hager.fr
help.hager.fr



FAQ

Answers to all your
questions



Retail price

For project costing

Software

Design and cost your electrical
installations with **hagercad.T**





Hager SE
Zum Gunterstal
66440 Blieskastel
Germany

hager.com

Dear reader,

**please be aware, this brochure is a template.
It can be adapted in product portfolio and
language to your local market needs. It is not
changeable according concept.**

Request for open data: cme.hager.com

Thank you for your attention.